

FAMO:

Mobiliário de escritório
Kima



Working Together.

Famo apresenta Kima. Um produto simples no que se refere às suas formas e com grandes qualidades de crescimento, graças a um sistema composto, que oferece soluções tanto para grandes instalações como para pequenos gabinetes. Desenhado por Jean-Louis Iratzoki

Famo presenta Kima. Un producto básico en cuanto a sus formas se refiere, y de grandes cualidades de crecimiento gracias a un sistema compositivo que ofrece soluciones tanto para grandes instalaciones como para pequeños despachos. Diseñado por Jean Louis Iratzoki.

Famo présente Kima. Un produit aux formes basiques dont les différents éléments s'associent pour constituer un programme de qualité. Son système de construction offre des compositions évolutives qui permettent d'équiper de grandes installations comme des bureaux individuels. Design: Jean Louis Iratzoki.

Famo presents Kima, a product based on simple forms with enormous room for growth, thanks to a compositional system that offers solutions for both large facilities and small offices. Designed by Jean Louis Iratzoki.



Ficoba. Architects: Pedro Astigarraga & José León Lasarte



01/ Kima
P 06

Construção
Constructividad
Construction
Constructivity

02/ Kima
P 12

Postos simples
Puestos simples
Postes simples
Simple stations

05/ Kima
P 40

Dimensões
Medidas
Dimensions
Measurements

06/ Kima
P 42

Acabamentos
Acabados
Finitions
Finishes

03/ Kima
P 28

Postos múltiplos
Puestos múltiples
Postes multiples
Multiple stations

04/ Kima
P 36

Reuniões
Reuniones
Réunions
Meetings

07/ Kima
P 44

Desenhador
Diseñador
Designer
Designer

08/ Kima
P 45

Créditos
Créditos
Crédits
Credits

Exemplos de construção da
mesa Kima com alguns dos seus
acessórios.

Ejemplos de constructividad de
la mesa Kima con algunos de
sus accesorios.

Exemple de construction du
bureau Kima avec quelques
accessoires.

Examples of the constructivity of
the Kima table, with some of its
accessories.



Kima.

010

011



Kima.

- | | | | | | |
|---|--|--|---|--|---|
| ①
Bloco suporte /
Cajonera soporte /
Caisson support /
Support drawers | ④
Tabuleiro lateral /
Bandeja lateral /
Bac latéral /
Side tray | ⑦
Peça de ligação para
bloco suporte /
Pieza unión mesa
a cajonera soporte /
Pièce d'union table au
caisson support /
Joining piece table to
support drawers | ⑨
Tampa polipropileno
do travamento /
Tapón polipropileno
de la viga /
Bouchon polypropylène
pour la barre /
Polypropylene cap for
cross beam | ⑪
Painel inferior /
Faldón metálico /
Voile de fond
métallique /
Bottom panel | ⑬
Painel superior em
tecido /
Separador en tejido /
Séparateur en tissu /
Fabric top panel |
| ②
Bloco suspenso /
Cajonera suspendida /
Caisson suspendu /
Suspended drawers | ⑤
Tabuleiro frontal /
Bandeja frontal /
Bac façade /
Front tray | ⑧
Tabuleiro lateral
para dossiers /
Bandeja lateral
para dossiers /
Bac latéral pour
dossiers /
File holder tray | ⑩
Peça de suspensão
de acessórios /
Pieza para suspensión
de accesorios /
Pièce suspension
accessoires /
Accessory holder part | ⑫
Cesto de papeis /
Papelera /
Corbeille papiers /
Waste paper | |
| ③
Porta-pastas /
Soporte para bolsos /
Support sacs /
Bag holder | ⑥
Painel superior /
Separador metálico /
Séparateur métallique /
Metal panel | | | | |

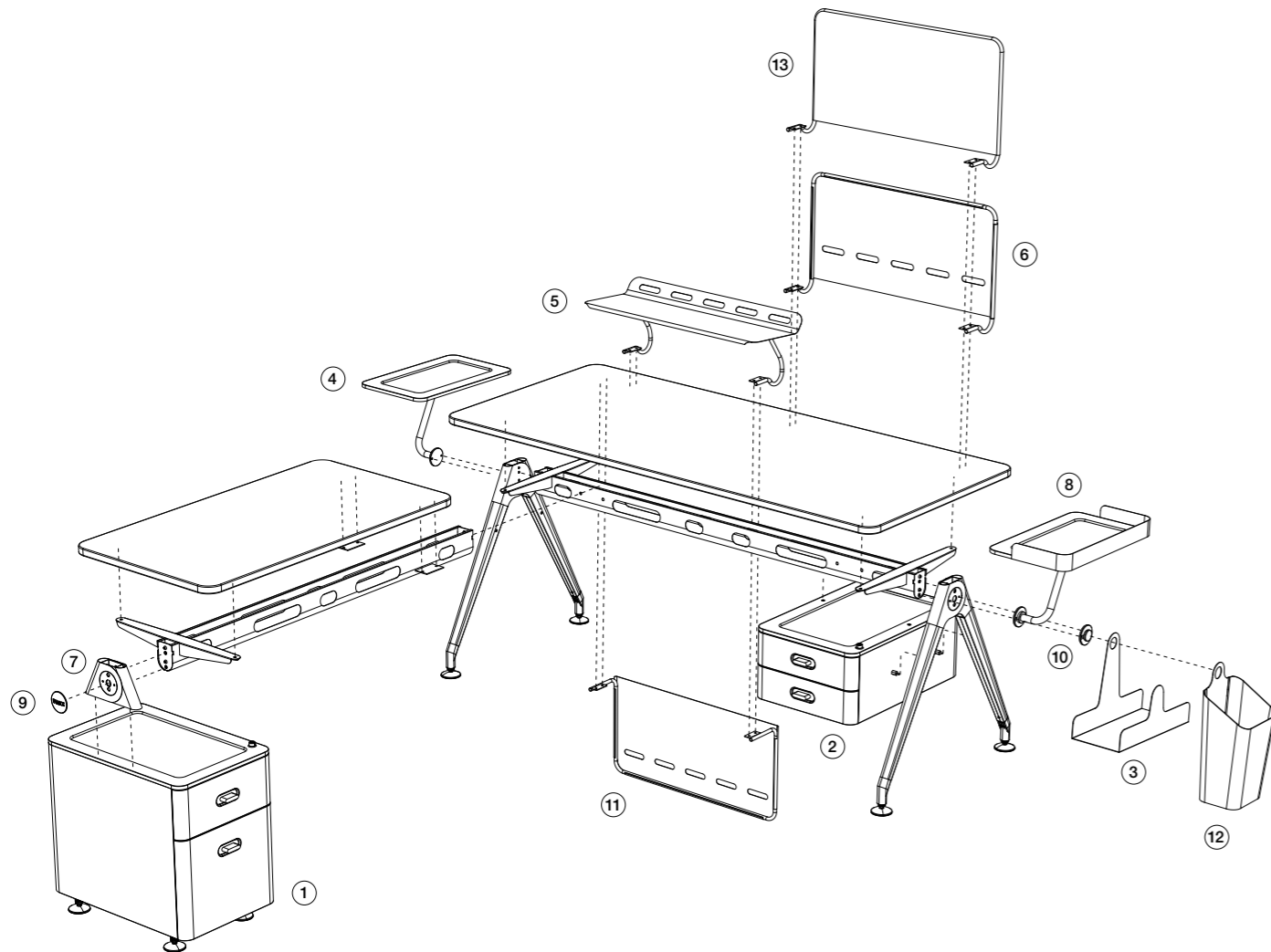

Decomposição / Despiece Eclaté / Part breakdown

Sistema composto de um amplo crescimento, com diferentes acessórios que facilitam o trabalho em equipa e proporcionam múltiplas soluções para lugares como escritórios, salas de reuniões, gabinetes de direcção etc., permitindo assim uma variada gama de soluções para personalização dos postos de trabalho.

13

Sistema compositivo de amplio crecimiento, con diferentes accesorios que facilitan el trabajo en equipo y proporcionan múltiples soluciones para lugares como oficinas, salas de reuniones, despachos de dirección etc., permitiendo así una variada gama de soluciones para la personalización de los puestos de trabajo.

Un système de construction à la carte, avec différentes configurations qui facilitent le travail en équipe et permet de multiples solutions pour les bureaux collectifs, salles de réunion et espaces individuels.
Kima: une large gamme à personnaliser.

Compositional system with room for growth and a number of different accessories to facilitate teamwork and offer multiple solutions for places such as work areas, meeting rooms and management offices, etc., thereby enabling a wide range of designs for lending a personal touch to the working environment.



Posto simple, Tipología 1
Puesto simple. Tipología 1
Poste simple. Type 1
Simple station. Type 1

P 14 / 21

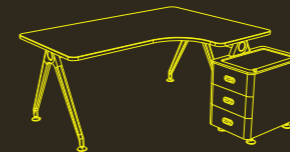

Posto simple, Tipología 2
Puesto simple. Tipología 2
Poste simple. Type 2
Simple station. Type 2

P 22 / 23

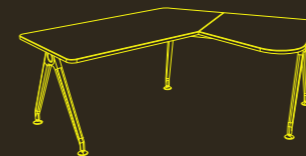

Posto simple, Tipología 3
Puesto simple. Tipología 3
Poste simple. Type 3
Simple station. Type 3

P 24

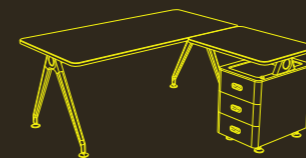

Posto simple, Tipología 4
Puesto simple. Tipología 4
Poste simple. Type 4
Simple station. Type 4

P 25

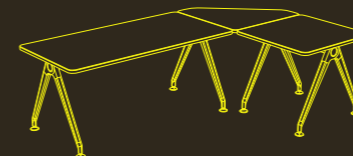

Posto simple, Tipología 5
Puesto simple. Tipología 5
Poste simple. Type 5
Simple station. Type 5

P 26 / 27

Posto simple, Tipologia 1
Puesto simple. Tipología 1
Poste simple. Type 1
Simple station. Type 1





18

19



Posto simple, Tipologia 1
Puesto simple. Tipología 1
Poste simple. Type 1
Simple station. Type 1



20



21



Posto simple, Tipologia 1
Puesto simple. Tipología 1
Poste simple. Type 1
Simple station. Type 1



Posto simple, Tipologia 2
Puesto simple. Tipología 2
Poste simple. Type 2
Simple station. Type 2

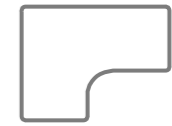

Posto simple, Tipologia 3
Puesto simple. Tipología 3
Poste simple. Type 3
Simple station. Type 3

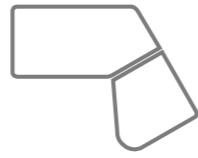

Posto simple, Tipologia 4
Puesto simple. Tipología 4
Poste simple. Type 4
Simple station. Type 4

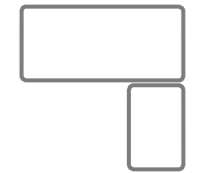

Posto simple, Tipologia 5
Puesto simple. Tipología 5
Poste simple. Type 5
Simple station. Type 5

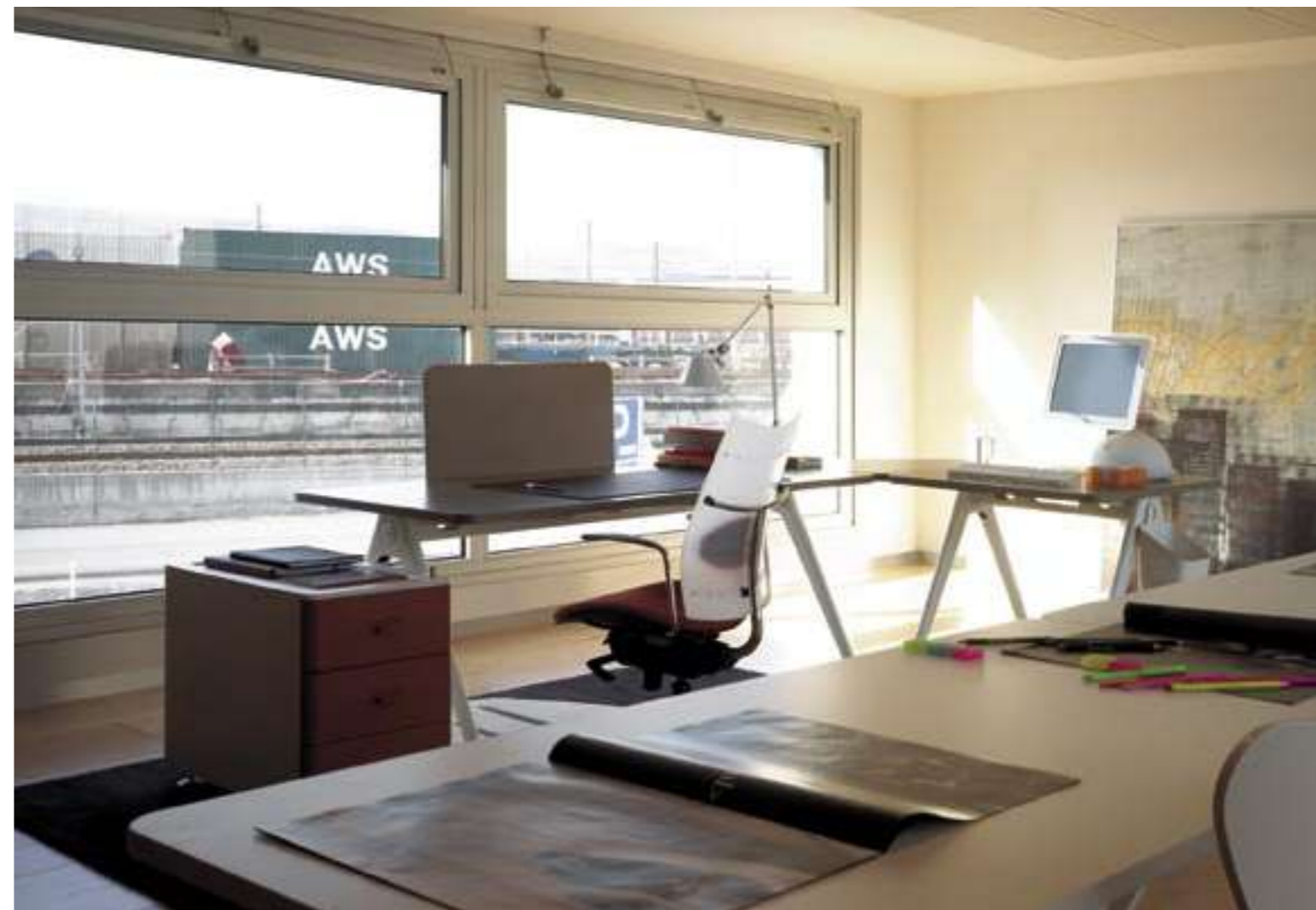
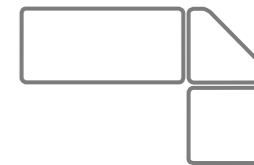

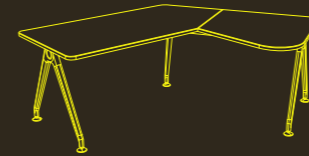

Posto múltiplo, Tipología 1
Puesto múltiplo. Tipología 1
Poste multiple. Type 1
Multiple station. Type 1

P 30 / 31

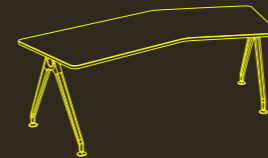

Posto múltiplo, Tipología 2
Puesto múltiplo. Tipología 2
Poste multiple. Type 2
Multiple station. Type 2

P 32 / 33

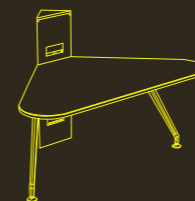

Posto múltiplo, Tipología 3
Puesto múltiplo. Tipología 3
Poste multiple. Type 3
Multiple station. Type 3

P 34 / 35

Posto múltiplo, Tipología 1
Puesto múltiple. Tipología 1
Poste multiple. Type 1
Multiple station. Type 1

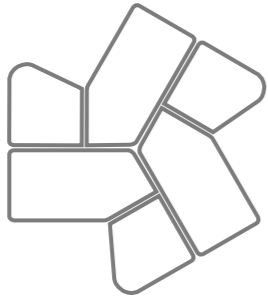

Posto múltiplo, Tipología 2
Puesto múltiple. Tipología 2
Poste multiple. Type 2
Multiple station. Type 2

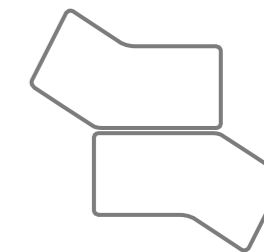

Posto de recepção
Puesto de recepción
Poste de reception
Reception area

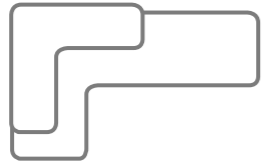

Posto múltiplo, Tipología 3
Puesto múltiple. Tipología 3
Poste multiple. Type 3
Multiple station. Type 3

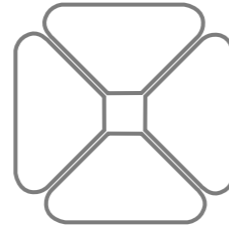

36



37



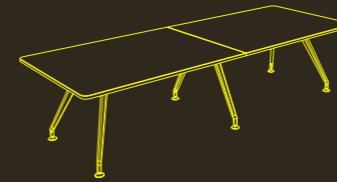

Mesa de Reuniões, Tipologia 1 P 38
Mesa de Reuniones. Tipología 1
Table de réunion. Type 1
Meeting room. Type 1



Mesa de Reuniões, Tipologia 2 P 38
Mesa de Reuniones. Tipología 2
Table de réunion. Type 2
Meeting room. Type 2

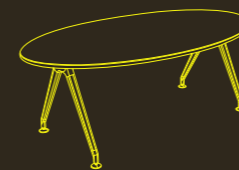

Mesa de Reuniões, Tipologia 3 P 39
Mesa de Reuniones. Tipología 3
Table de réunion. Type 3
Meeting room. Type 3

Mesa de Reuniões, Tipologia 1
Mesa de Reuniones. Tipología 1
Table de réunion. Type 1
Meeting room. Type 1

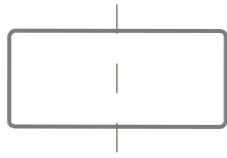

Mesa de Reuniões, Tipologia 2
Mesa de Reuniones. Tipología 2
Table de réunion. Type 2
Meeting room. Type 2



Mesa de Reuniões, Tipologia 3
Mesa de Reuniones. Tipología 3
Table de réunion. Type 3
Meeting room. Type 3

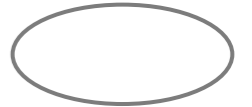

05/ Kima.

Dimensões / Medidas / Measurements / Dimensions

SECRETÁRIAS / MESAS / TABLES / DESKS

POSTOS SIMPLES / PUESTOS SIMPLES POSTES SIMPLES / SIMPLE STATIONS

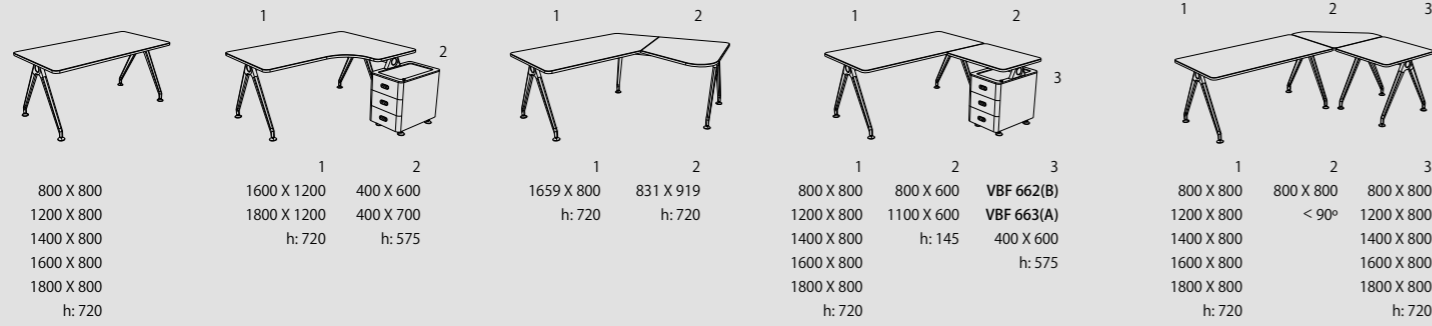

POSTOS MÚLTIPLOS / PUESTOS MULTIPLES POSTES MULTIPLES / MULTIPLE STATIONS

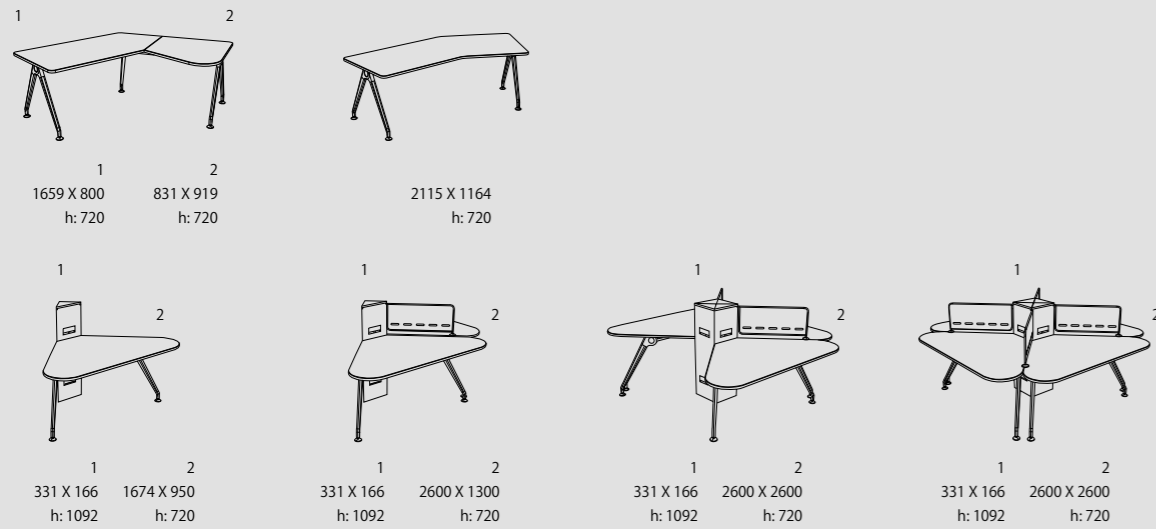

REUNIÕES / REUNIONES RÉUNIONS / MEETINGS



BLOCOS DE GAVETAS / CAJONERAS / CAISSONS / PEDESTALS

SUSPENSO, LATERAIS E RODADOS / SUSPENDIDOS, LATERALES Y RODANTES TIROIRS SUSPENDUS, LATÉRAUX ET COULISSANTS / HANGING, SIDE AND ON CASTORS



FIXOS OU SUPORTE / FIJAS O SOPORTE TIROIRS FIXES OU À SUPPORT / FIXED OR AS A SUPPORT

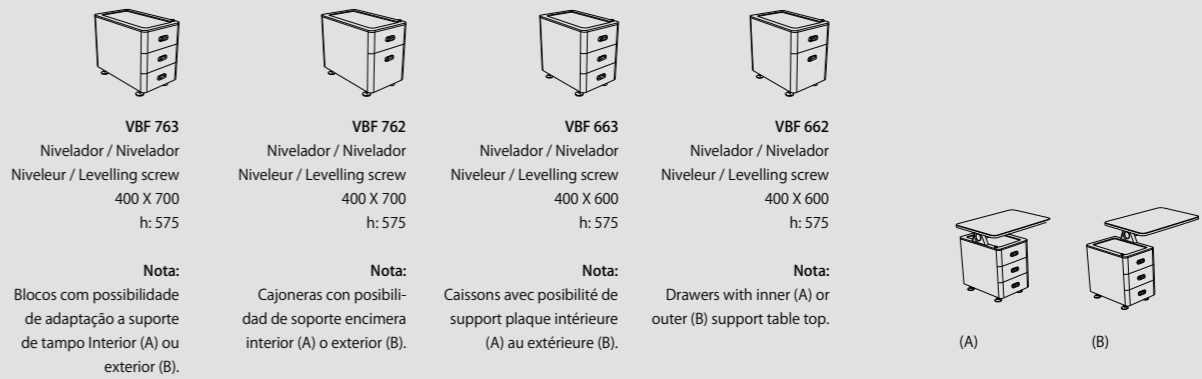

ACCESÓRIOS / ACCESORIOS ACCESSOIRES / ACCESSORIES

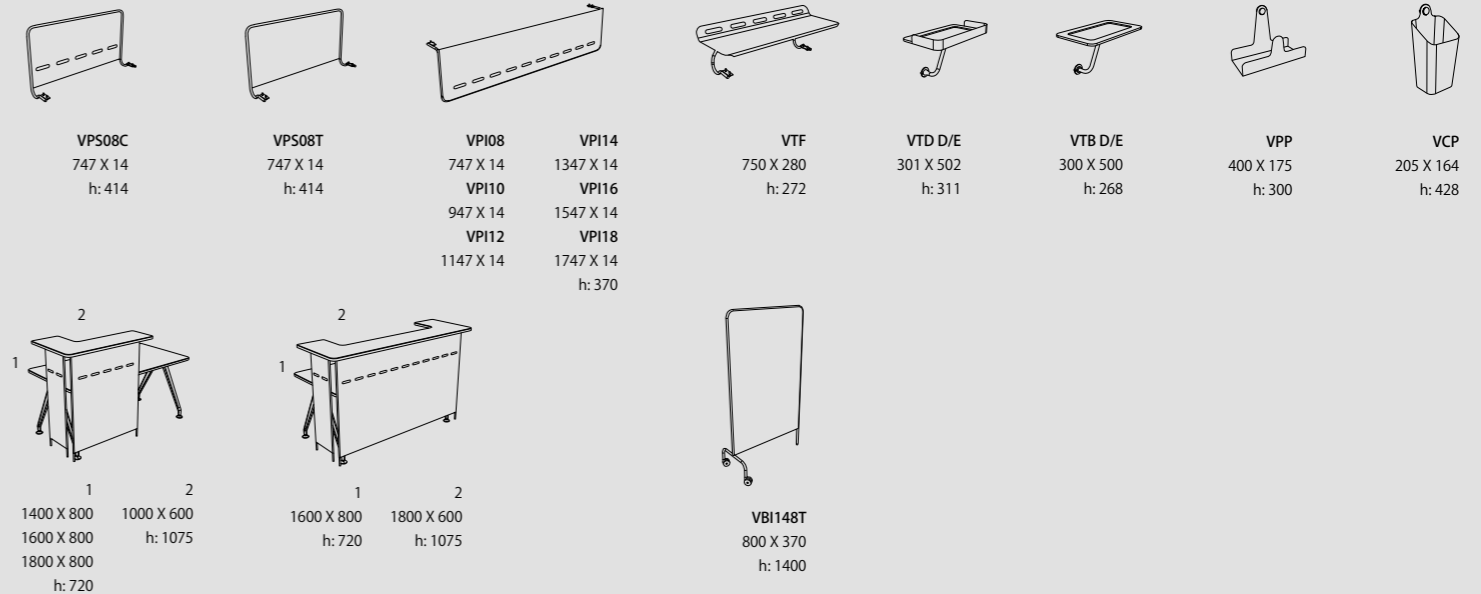

SECRETÁRIAS / MESAS /
TABLES / DESKS

Tampos
Encimeras
Plateaux
Worktops

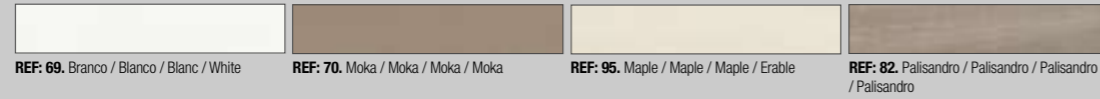

Estrutura / Estructura /
Structure / Structure

Plásticos dos pés / Plásticos de patas /
Embouts caoutchouc pour les pieds / Plastic parts of legs

Combinações de Cores
Combinaciones de color
Combinaisons couleurs
Colour combinations

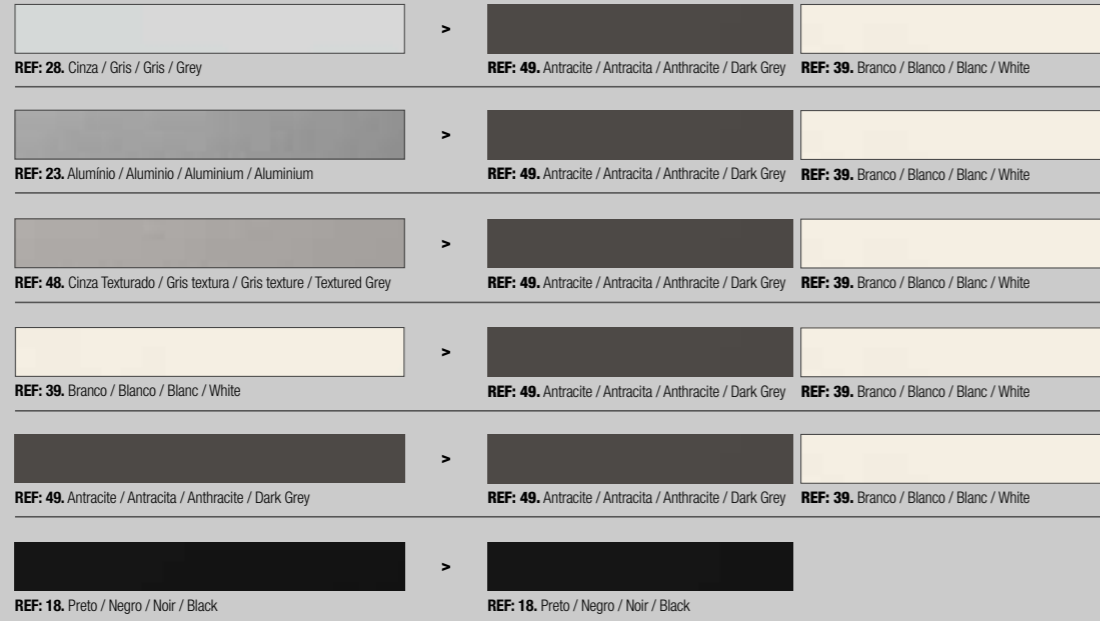

REF: 82. Palisandro / Palisandro /
Palisandro / Palisandro

REF: 18. Preto / Negro / Noir / Black

REF: 28. Cinza / Gris / Gris / Grey

REF: 23. Alumínio / Aluminio /
Aluminium / Aluminium

REF: 39 . Branco / Blanco / Blanc / White

REF: 48. Cinza Texturado / Gris textura /
Gris texture / Textured Grey

BLOCOS E TABULEIROS / CAJONERAS Y BANDEJAS /
CAISSONS ET BACS / DRAWERS AND TRAYS

Estruturas de blocos e braços de tabuleiros
Estructuras de cajoneras y brazos de bandejas
Structures caissons et bras des bacs
Structure of drawers and arms of tray

Frentes de blocos e tabuleiros
Frentes de cajoneras y bandejas
Façades caissons et bacs
Fronts of drawers and trays

Combinações de Cores
Combinaciones de color
Combinaisons couleurs
Colour combinations

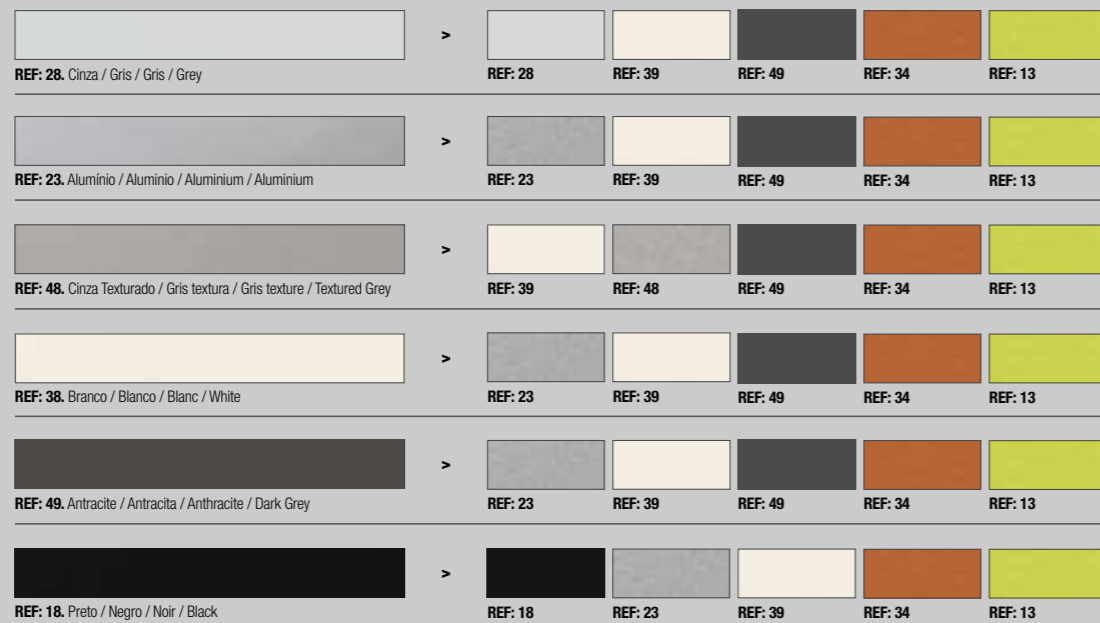

REF: 49. Antracite / Antracita /
Anthracite / Dark Grey

REF: 34. Laranja / Naranja /
Orange / Orange

REF: 13. Verde / Verde /
Vert / Green

**Jean Louis Irtzoki.**

Desenhador industrial, nasceu em San Juan de Luz, País Basco, em 1965. Licenciado em arquitectura de design de interiores pela Escola Boule Paris, especializou-se em desenho industrial na Escola Superior Experimental de Madrid. Trabalhou vários anos em agências parisienses. Em 1998 abriu o seu próprio atelier de desenho, dedicando-se à criação industrial. Encontra-se actualmente activo no sector de desenho de mobiliário tanto para escritório como para casa, colaborando com conhecidas empresas francesas, espanholas e agora portuguesas.

Jean Louis Irtzoki.

Designer industriel, né en 1965 à Saint-Jean-de-Luz dans le Pays Basque Français, diplômé en architecture intérieure à l'école Boule-Paris, il se spécialise dans le dessin industriel à L'école Expérimentale de Madrid. Il a travaillé plusieurs années dans des agences parisiennes. En 1998, il ouvre son propre atelier de design et se consacre à la création industrielle. A l'heure actuelle il travaille dans le monde du meuble, pour les bureaux comme pour la maison en collaboration avec d'importantes entreprises françaises, espagnoles et à présent portugaises.

Jean Louis Irtzoki.

Diseñador industrial nacido en San Juan de Luz, País Vasco en 1965. Diplomado en arquitectura de interior por la Escuela Boule-Paris, se especializa en diseño industrial en la Escuela Experimental de Madrid. Trabaja varios años en agencias parisinas. En 1998 abre su propio taller de diseño dedicándose a la creación industrial. Es el mundo del mueble al que se dedica últimamente. Tanto mobiliario de oficina como de hogar, colaborando con conocidas empresas francesas, españolas y ahora también portuguesas.

Jean Louis Irtzoki.

Industrial designer, born in Saint Jean de Luz, Basque Country in 1965. Graduated in interior architecture at the Boule School-Paris and specialised in Industrial Design at the Experimental School of Madrid. Worked for several years in Parisian agencies. In 1998 he opened his own design workshop, wholly dedicated to industrial creation. Recently he has been involved in the world of furniture. Both office and home furniture. He works together with French, Spanish and now a Portuguese company.

Fabricante do produto / Fabricante de producto / Product manufacturer / Fabricant du produit :

FAMO

Realização do catálogo / Realización de catálogo / Réalisation du catalogue / Catalogue by :

MARTIN & ZENTOL
www.myz.es

Ano de edição / Año de edición / Ane d'edition / Year of publication :

4 / 2005

Mobiliário de escritório
Kima

FAMO:



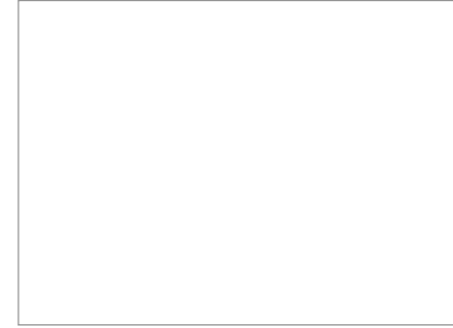

FAMO:

Working Together.

Indústria de Mobiliário de Escritório, Lda.
Arcas - Cristelos
4620-131 Lousada.
T + 351 255 810 580 F + 351 255 810 589
famo@mail.telepac.pt
www.famo.pt