

punt

ART, CRAFT & DESIGN

A R T , C R A F T & D E S I G N

As on a sculpture, each encounter and each material is the origin of the magic of a piece that intends to provide a balance between emotions and functionality.

Como en una escultura, cada encuentro y cada material son la génesis de la magia de una pieza que aspira a dar emoción y función a partes iguales.

Storage. Almacenaje



Chicago collection -10-



Malmö collection - 32-



Stockholm collection - 56-



Sussex collection -82-



Slat collection -92-



Tactile -96-



Literatura selection -104-



Storage. Almacenaje



Literatura Open -120-

Literatura Classic -134-

Tables. Mesas



Stockholm table -138-

Mitis -156-

Bass -168-

HPW -174-

Núcleo -180-

Stk -184-

Breda -188-

Seating. Asientos



Amor Cortese - 194-

Gin -198-

Breda -204-

Hug -208-

Mava -218-

Tyris -226-

Others. Otros

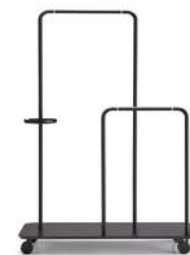

Breda bed -232-

Ernest -236-

Platel -240-

Mai Tai -242-

Nido -244-

Cuatro -246-

Elx -248-

STORAGE
ALMACENAJE



CHICAGO
Norm Architects





INDEX







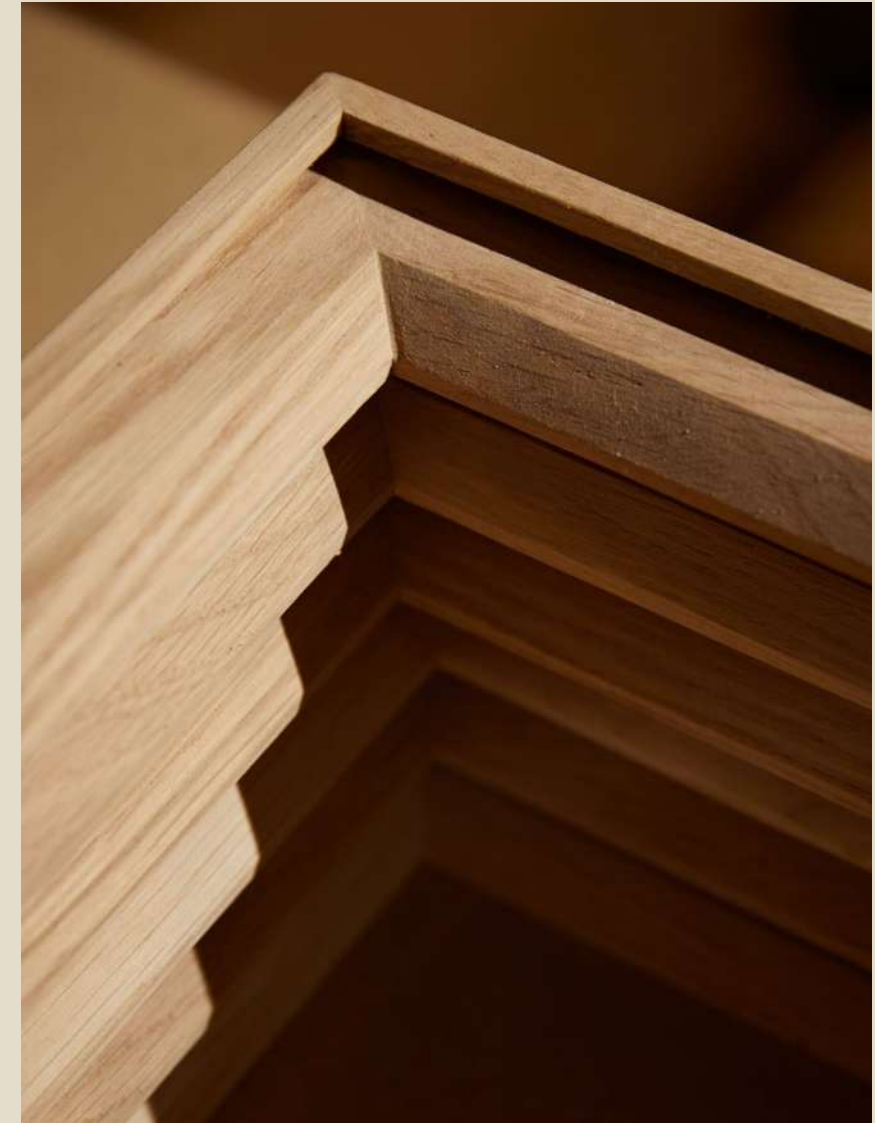



CLICK VIDEO

There is the option of internal led lighting. The light turns on / off when one of the doors opens / closes. The glass door version also includes a movement sensor located underneath the unit that activates the light with the foot when the doors are closed.

Opción de Luz interior en cualquier aparador. Led de gran calidad con sensor de encendido y apagado mediante su apertura y cierre de puertas. Además los modelos con puerta de vidrio también incluyen un sensor de movimiento que permite encender y apagar con el pie la iluminación interior del aparador ajeno a que las puertas estén cerradas o abiertas.



Inspired by the modernist architecture and the unobstructed repetitive building techniques known from the mid century, the Chicago cabinet collection stands as a tribute to this particular architectural period.

With its light and floating appearance the sideboard almost appears as a piece of modern architecture itself.

The elevated solid steel construction gives stability and structure while the floating wooden cabinet adds the spacial impression.

The table top functioning as a floating roof with its extended eaves completes the minimalistic framework combining three simple natural materials, wood, steel and stone.

Inspirado por la arquitectura modernista y las técnicas de construcción repetitivas y sin obstáculos conocidas desde mediados de siglo, la colección de aparadores Chicago se define como un tributo a este período arquitectónico particular.

Con su apariencia ligera y flotante, el aparador casi parece una pieza de arquitectura moderna en sí misma.

La construcción de acero sólido elevado brinda estabilidad, mientras que el cuerpo de madera agrega la impresión espacial.

El tablero de la mesa que funciona como un techo flotante con sus aleros extendidos completa el marco minimalista que combina tres materiales naturales simples, madera, acero y piedra.

Norm Architects









The **Jurassic Marble** comes from a Spanish quarry, located in Zucaina, **Castellón**, at an altitude of 800 meters and more than 60 km away from the coast. It is a seabed from the Jurassic period (it is dated between 163 and 152 million years ago) that for thousands of years has been settling and trapping an exceptional concentration of Nerinea fossils. For that reason, this quarry is a unique place in the world. Each rock extracted is a different, exclusive, and rare object, which keeps within it the trace of life from 150 million years ago.

El **mármol Jurassic** proviene de una cantera española, localizada en Zucaina, **Castellón**, a 800 metros de altitud y a más de 60 km de la costa. Se trata de un lecho marino del periodo Jurásico (está datado entre 163 y 152 millones de años) que durante miles de años se fue sedimentando y atrapando en su interior una concentración excepcional de fósiles de nerineas. Esto hace de esta cantera un lugar único en el mundo. Cada roca extraída es un objeto diferente, exclusivo y escaso, que guarda en su interior la huella de la vida de hace 150 millones de años.





M A L M Ö
M a r i o R u i z



- wall system -







CUSTOMIZABLE LENGTH OVER 3 METER

Composiciones superiores a 3 metros

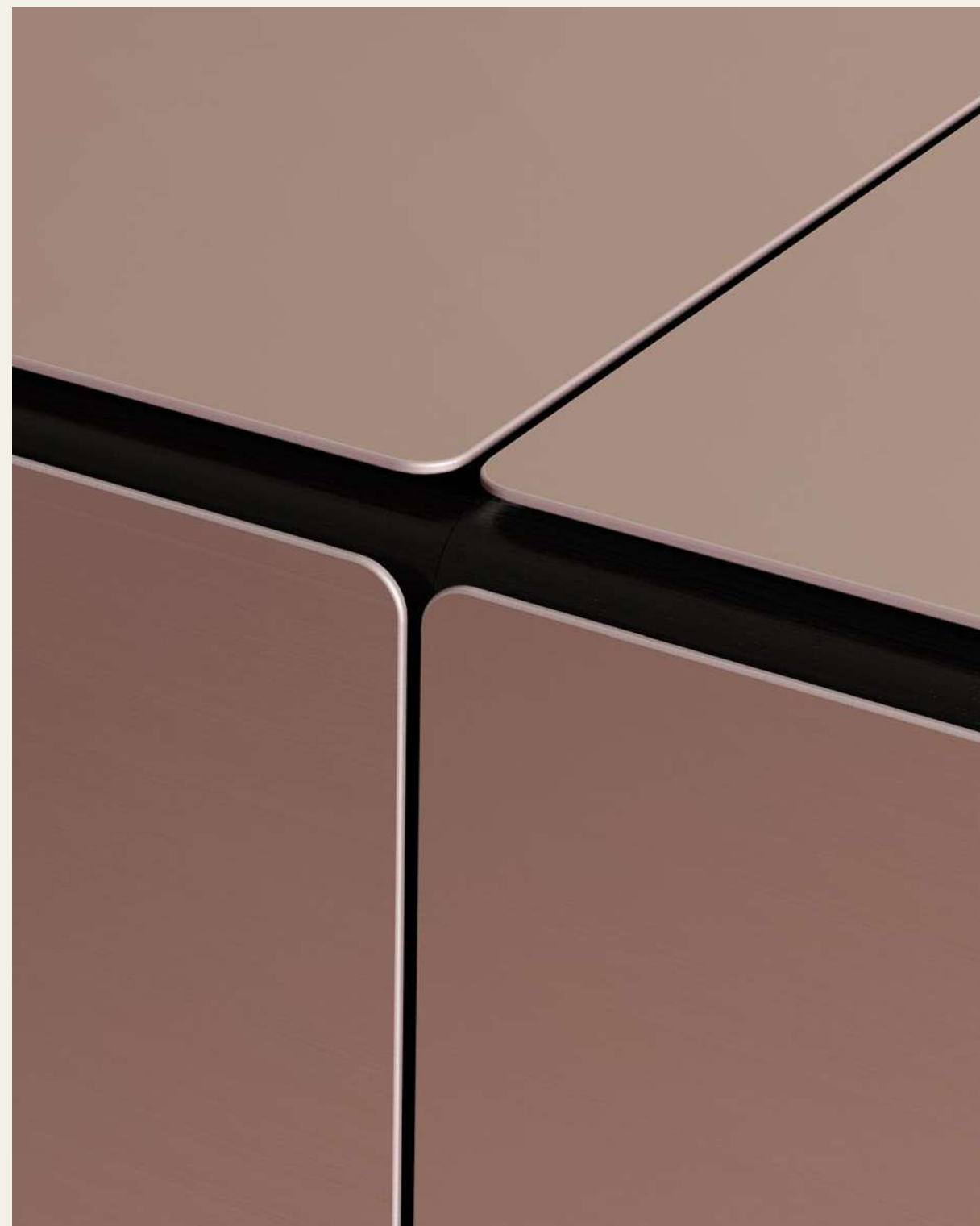











With soft and elegant lines, the collection uses different materials to express its plural nature.

Sobre líneas suaves y elegantes, la colección propone diferentes materiales para expresar su faceta más plural.

Mario Ruiz.









STOCKHOLM

Mario Ruiz





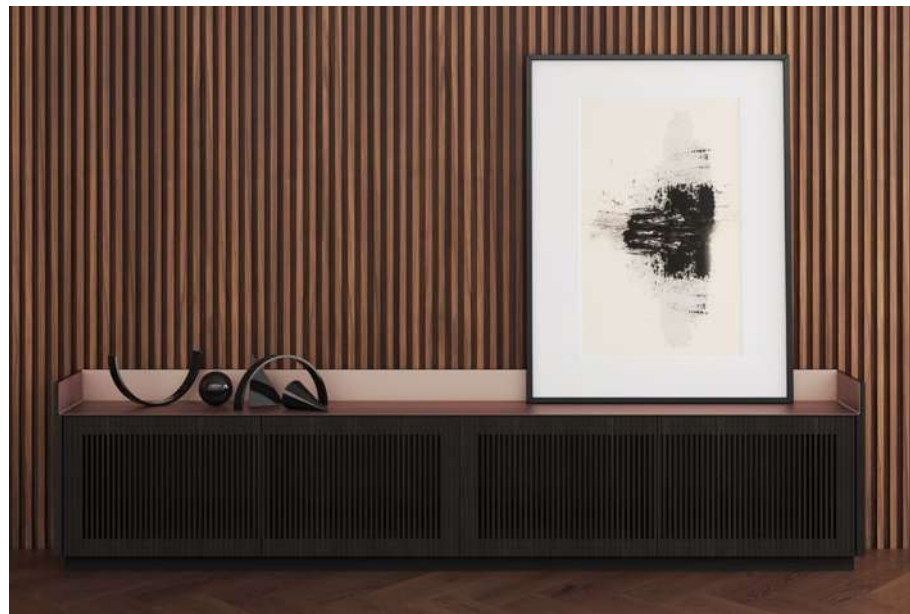

Customizable length over 3 meters
Composiciones superiores a 3 metros







Its craftsmanship makes the Stockholm collection look like a sculpture, with a good design and functionality

Su artesanía hace que la colección Stockholm se contemple como una escultura con un buen diseño y funcionalidad

















SUSSEX

Terence Woodgate



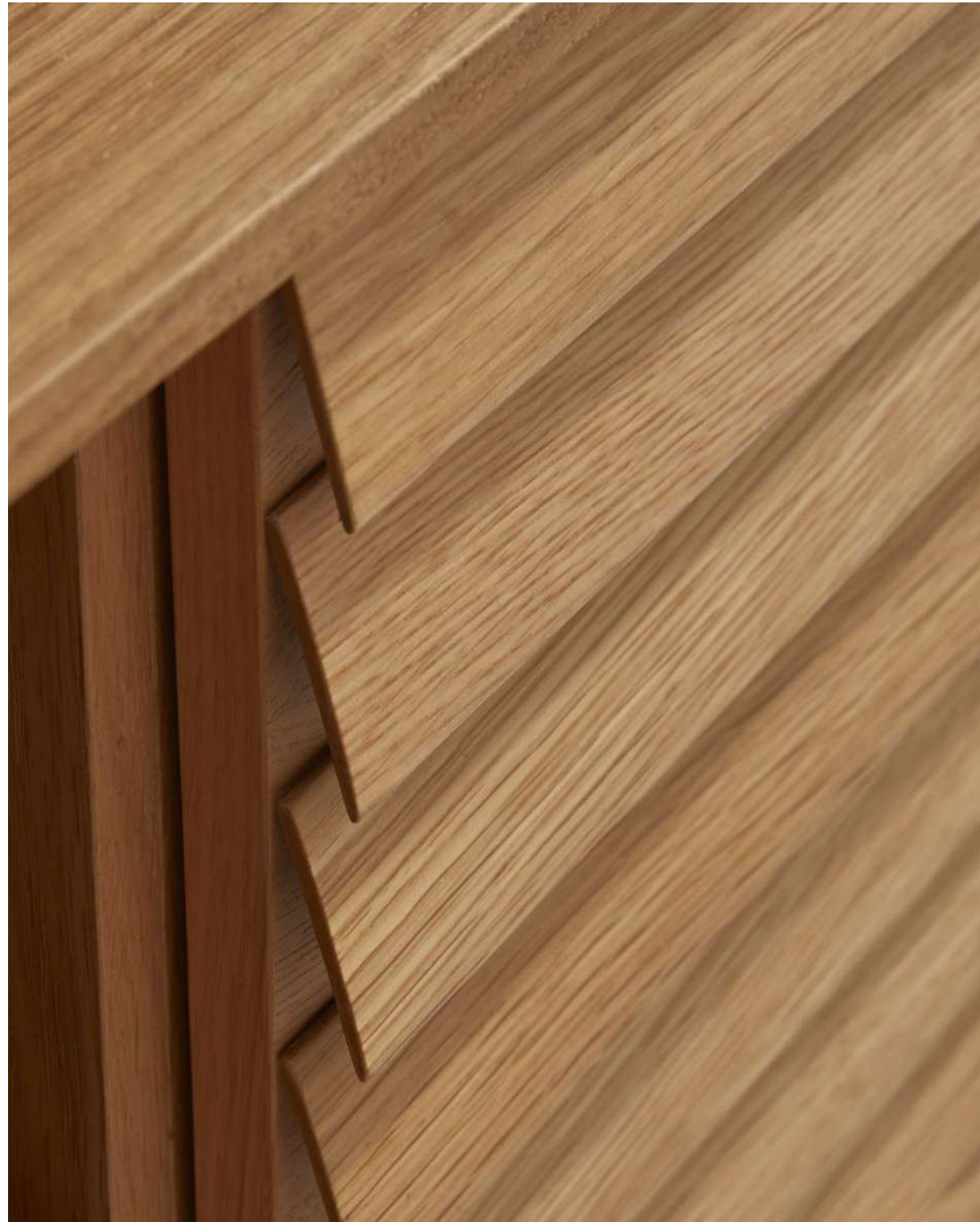



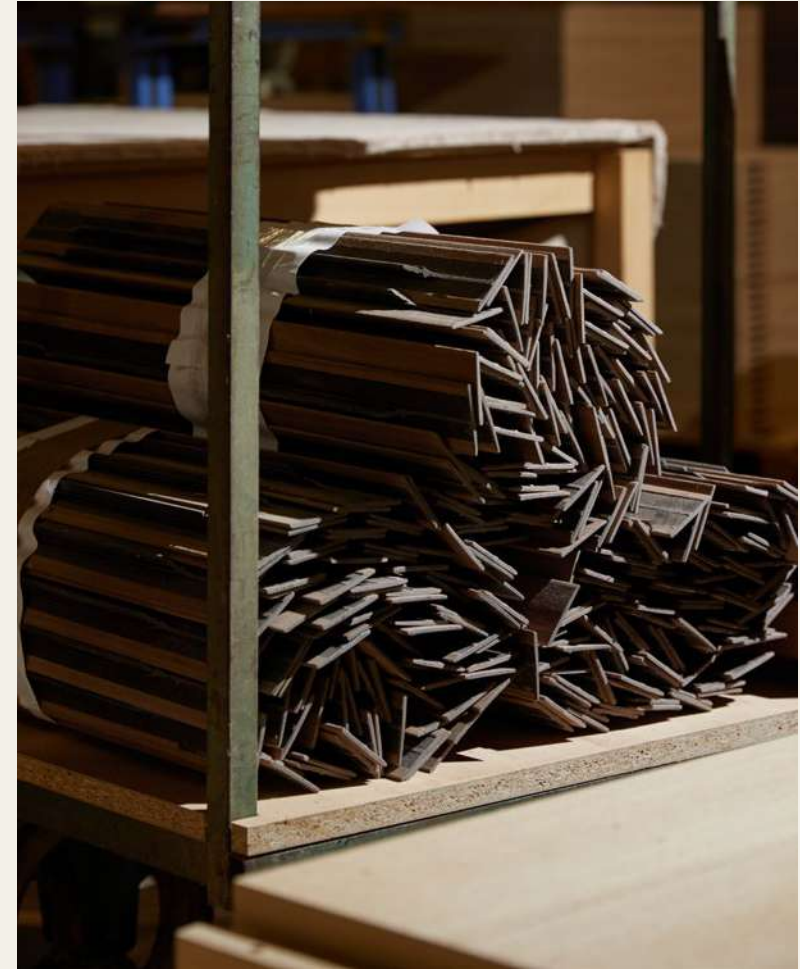





SLAT
Marc Krusin



Planes and volumes, composed as needed. A geometrical game, a game of colours, surfaces and textures. Slats is a series of building blocks that can be constructed like Lego to the required specification so as to create an interior architecture of positive and negative volumes - blocks and gaps. Proportion, detail, colour and material combination are the guiding elements.

Planos y volúmenes compuestos según tus necesidades. Un juego de geometría, un juego de colores, superficies y volúmenes. Slats es una serie de bloques de construcción que pueden montarse como un Lego según se requiera para crear una arquitectura interior con volúmenes positivos y negativos -bloques y huecos. La proporción, el detalle, el color y la combinación de materiales son los elementos fundamentales.

Marc Krusin.





TACTILE

Terence Woodgate



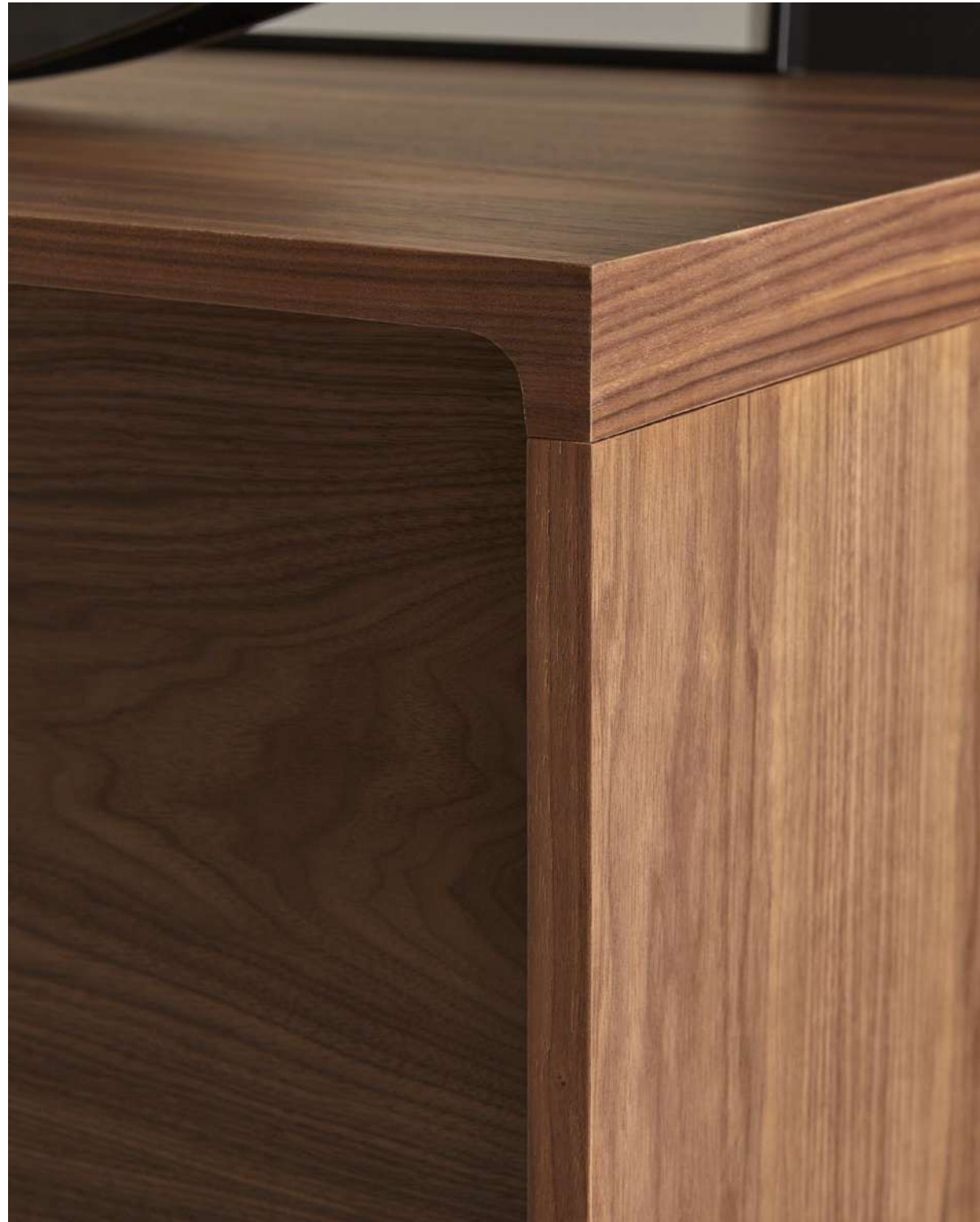



Design is a fusion of art and technology. As it was a cabinet that invited you to touch, Tactile had to be the name.

El diseño es la unión del arte y la tecnología. Como era un aparador que invitaba a tocarlo, tenía que llamarse Tactile.

Terence Woodgate.





L I T E R A T U R A S E L E C T I O N
V i c e n t M a r t í n e z















SELECTION SIDEBOARD
Vicent Martinez







L I T E R A T U R A O P E N
Vicent Martínez













OPEN SIDEBOARD
Vicent Martínez







L I T E R A T U R A C L A S S I C 1 9 8 5

V i c e n t M a r t í n e z





STOCKHOLM

Mario Ruiz



















MITIS
Mario Ruiz







*The essence of the sculptor captured in an artisan table.
All of our technical experience striving for beauty.*

*Toda la esencia del escultor en una mesa de autor.
Toda la experiencia técnica al servicio de la belleza.*









BASS

Borja Garcia









H P W
P u n t t e a m









NÚCLEO
Victor Carrasco







STOCKHOLM LOW TABLE

Mario Ruiz







B R E D A T A B L E

B o r j a G a r c í a







AMOR CORTESE
Mónica Armani







GIN

Terence Woodgate









B R E D A
B o r j a G a r c í a







H U G

Estudi Manel Molina





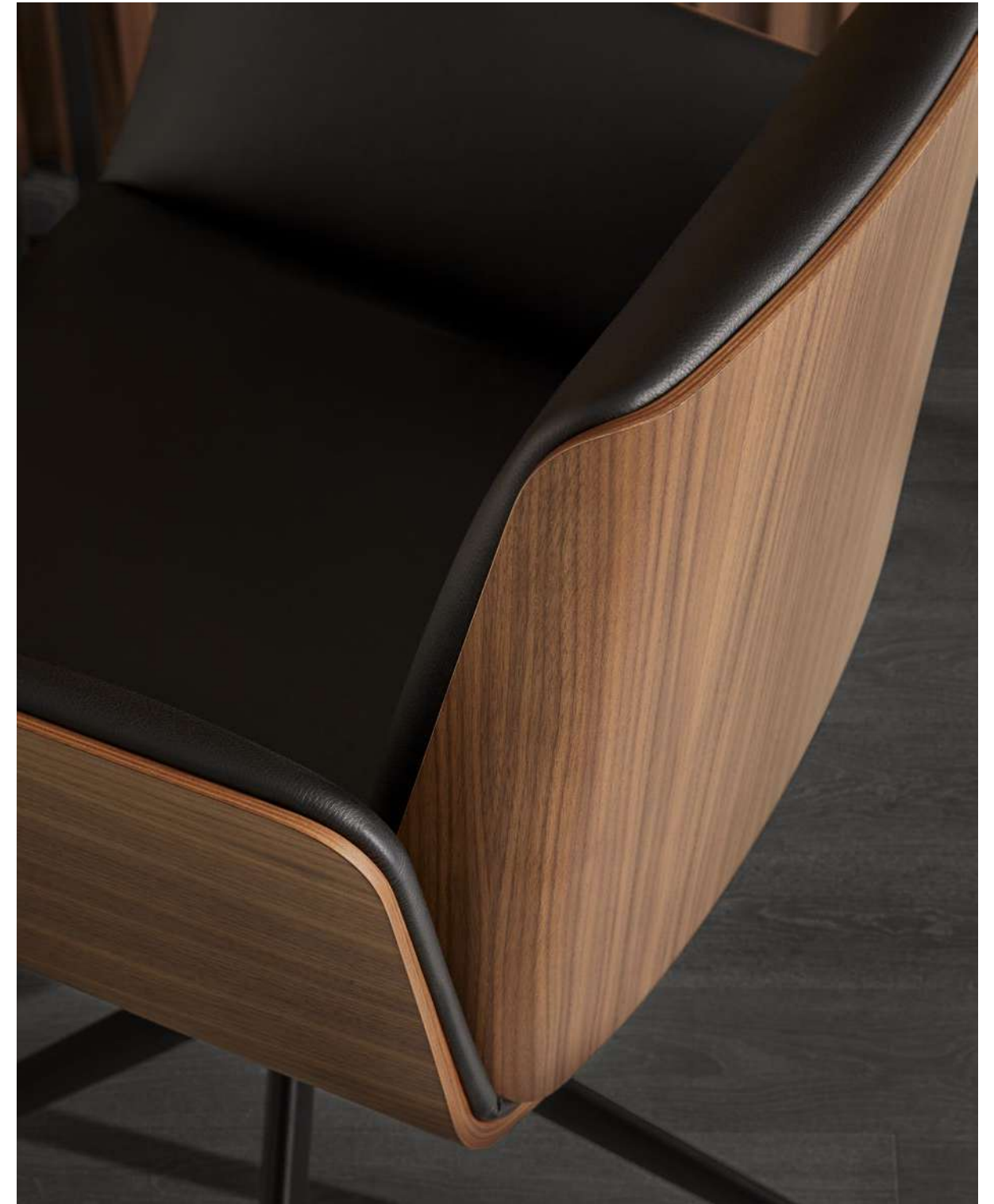

*High-end woods and metals
together with soft textiles
and padding.
Versatility and beauty for
personal and professional
lives.
An irresistibly sumptuous
sensory experience.*

*Maderas y metales nobles
junto a suaves textiles y
espumas.
Versatilidad y belleza para
lo personal y lo profesional.
Un abrazo irresistible para
los sentidos.*

Manel Molina.







MAVA
STEPHANIE JASNY





The know-how of a craftsman and a good design result in a product that we look at as a work of art.

El saber hacer de un artesano junto un buen diseño dan como resultado un producto que contemplamos como una obra de arte.







TYRIS
O d o s d e s i g n

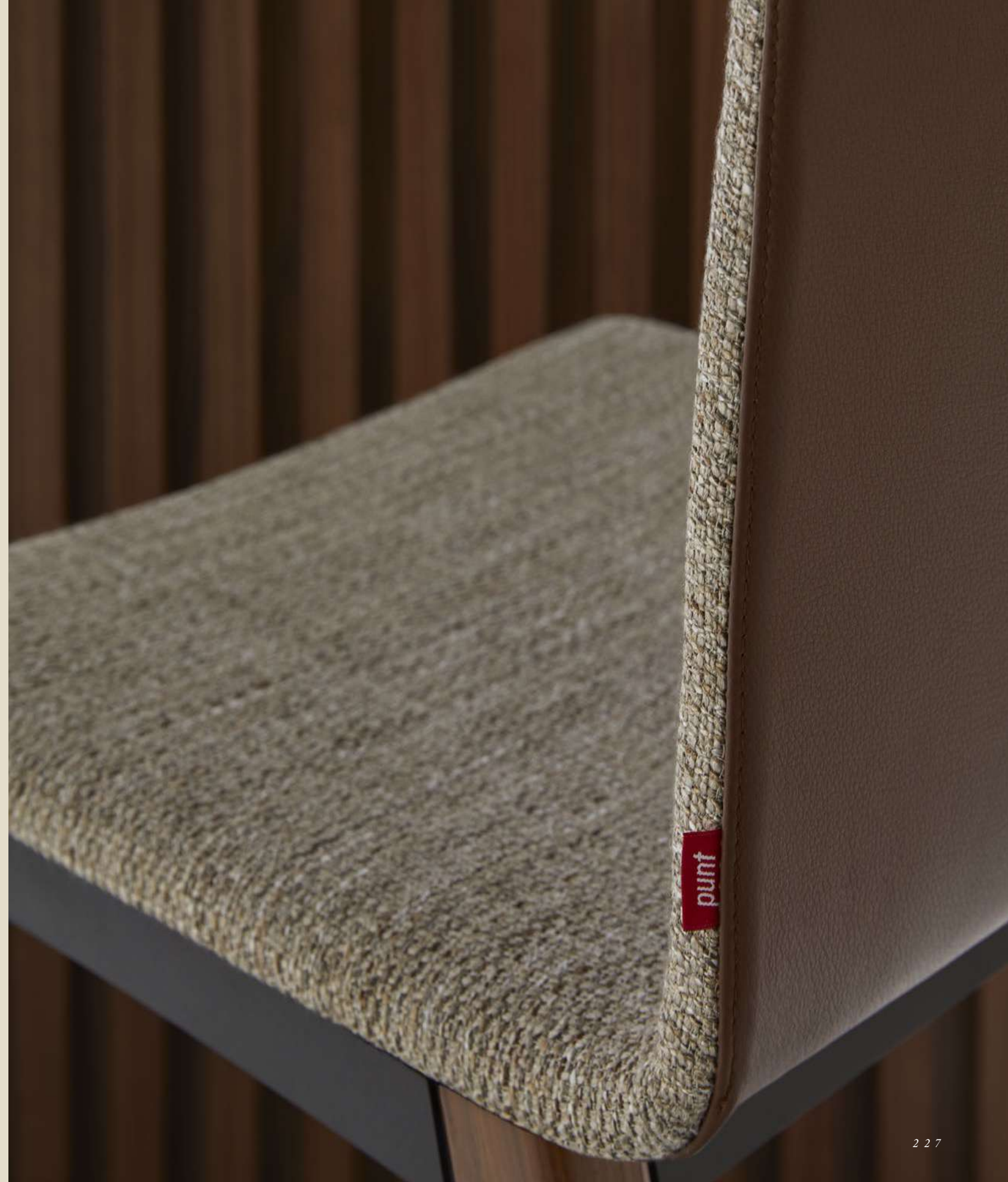





B R E D A B E D
B o r j a G a r c í a







ERNEST
Borja Garcia



We have combined discovering new approaches and listening to requirements with a sensitivity for design. The result is a product that combines form and creativity and considers the smallest detail, from the selection of noble materials to each choice of dye.
This creative process is an adventure shared by designers, artisans, and industrialists together.

El descubrimiento de nuevos enfoques y la escucha de necesidades combinadas con una sensibilidad por el diseño, dan como resultado un producto que reúne forma y creatividad, teniendo en cuenta el más mínimo detalle, desde la selección de materiales nobles, hasta cada elección de tinte.

Este proceso de creación es una aventura conjunta entre diseñadores, artesanos e industriales.





PLATEL
Note design studio





MAI TAI
Odosdesign



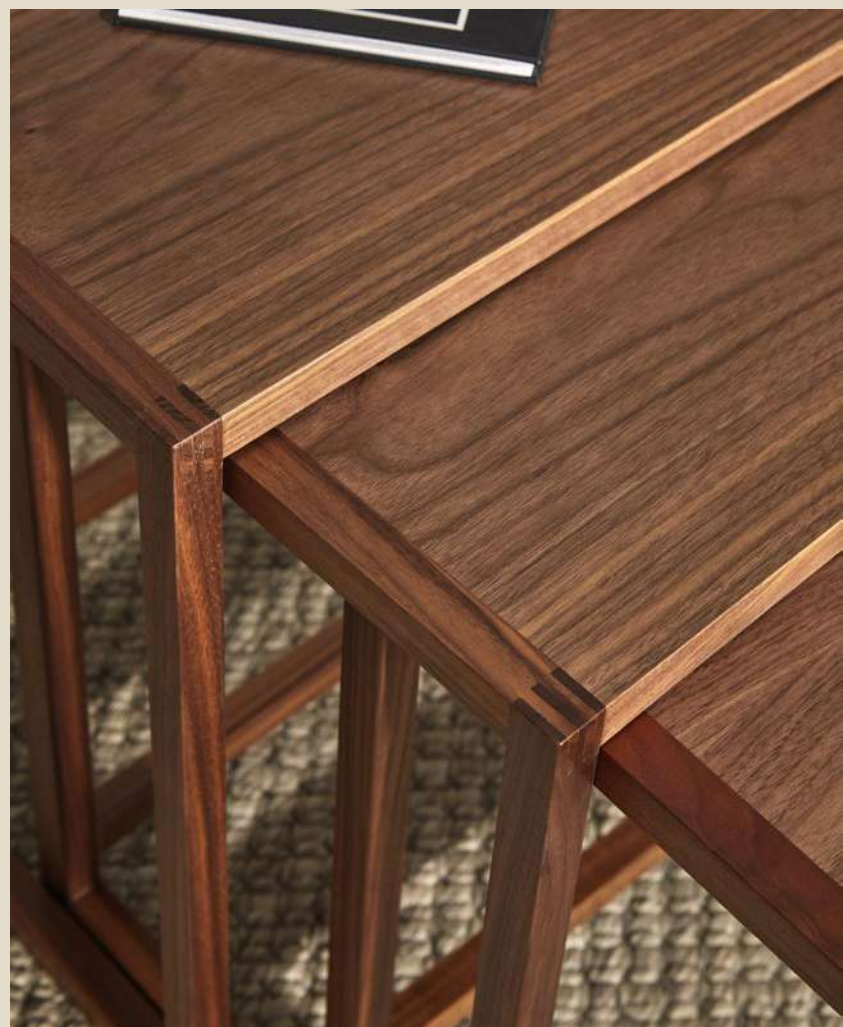

N I D O

Jesé Martínez Medina





CUATRO
NATHAN YONG





E L X

Vicent Martínez



DESIGNERS



NORM ARCHITECTS



MARIO RUIZ



MARC KRUSIN



NATHAN YONG



BORJA GARCÍA



NOTE DESIGN



STEPHANIE JASNY



TERENCE WOODGATE



MONICA ARMANI



VÍCTOR CARRASCO

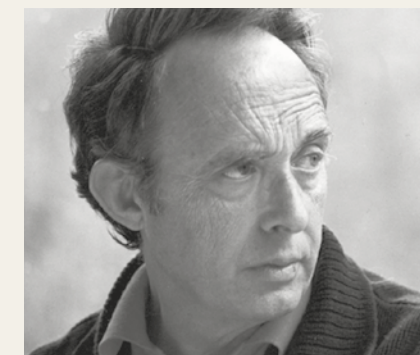

J.MARTÍNEZ MEDINA



ESTUDI MANEL MOLINA



VICENT MARTÍNEZ



ODOSDESIGN

TECHNICAL
TÉCNICO

MALMÖ WALL SYSTEM

Mario Ruiz. 2020

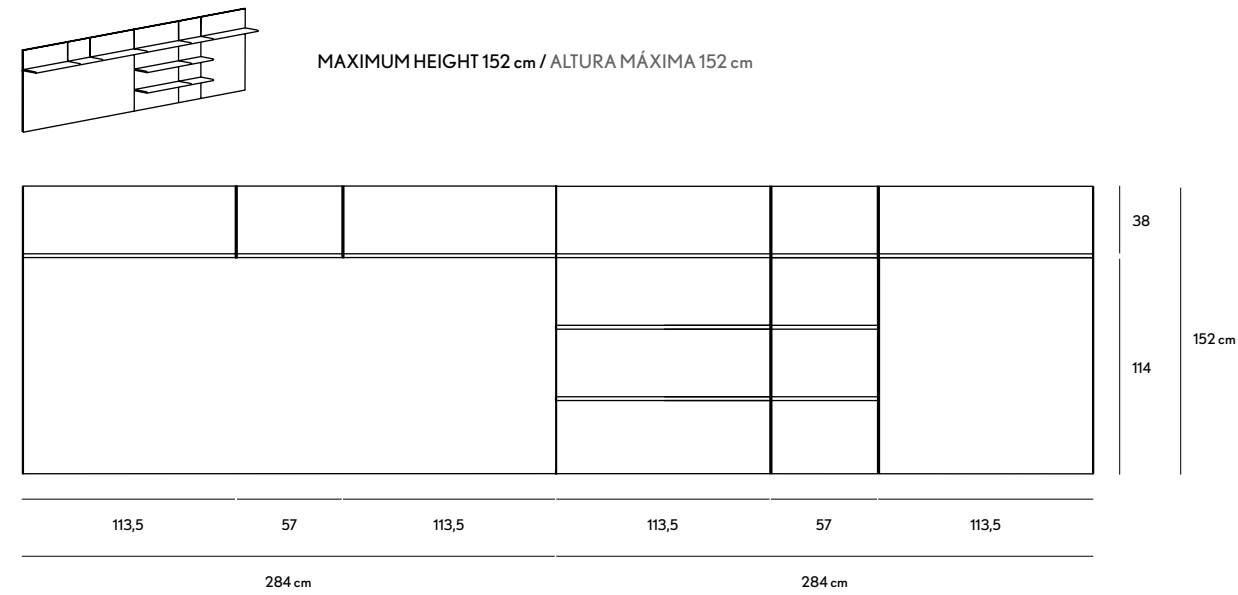

COMPOSITIONS: 29,5 CM DEPTH. COMPOSICIONES: 29,5 CM PROFUNDIDAD

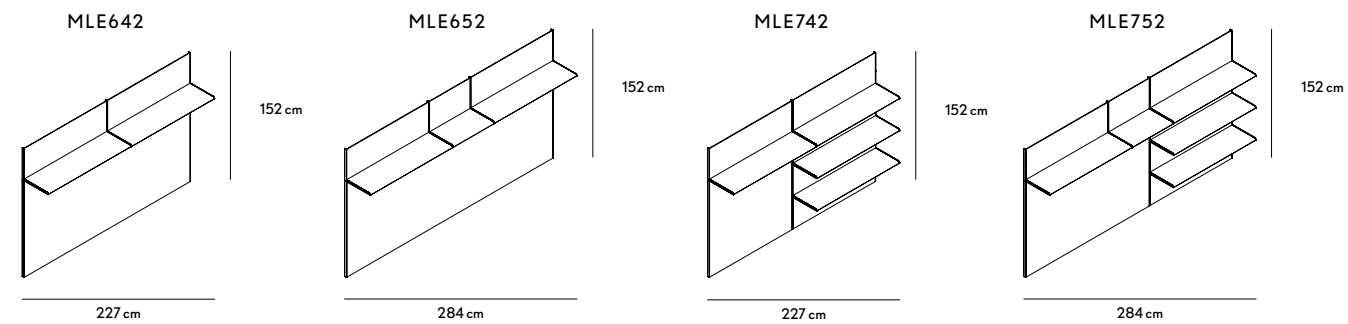
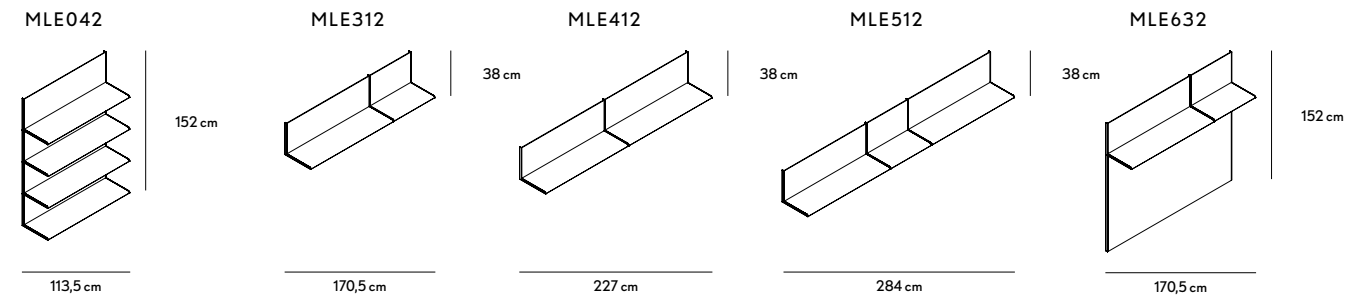

MALMÖ

Mario Ruiz. 2018

MALMÖ BEDSIDE. MESITA DE NOCHE.

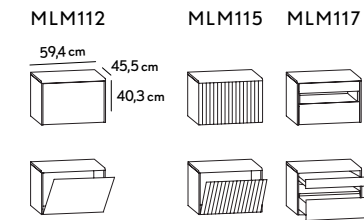

MALMÖ

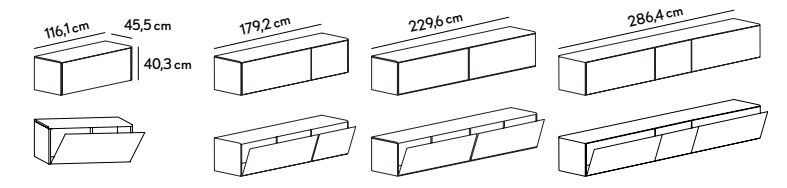

MALMÖ OPEN

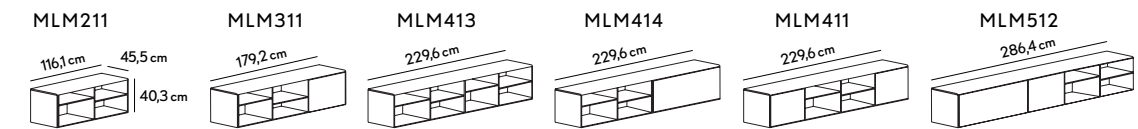

MALMÖ TECHNIC

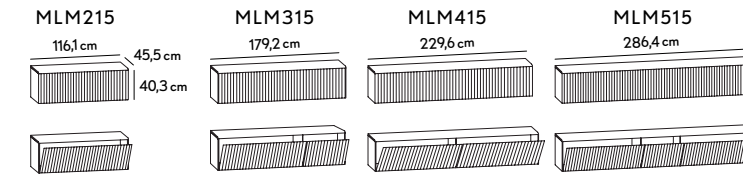

MALMÖ WITH DRAWERS. MALMÖ CON CAJONES

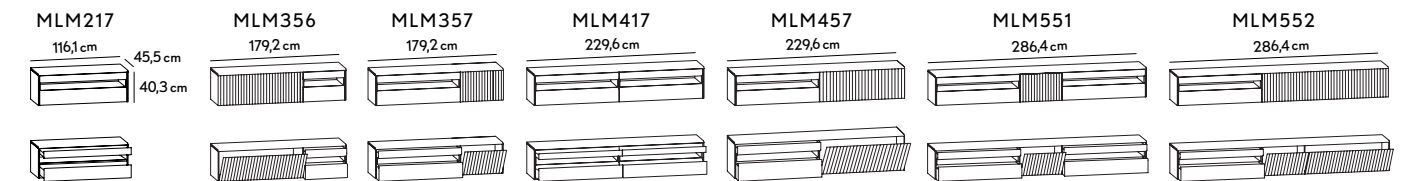

MALMÖ CUPBOARD. ALACENA

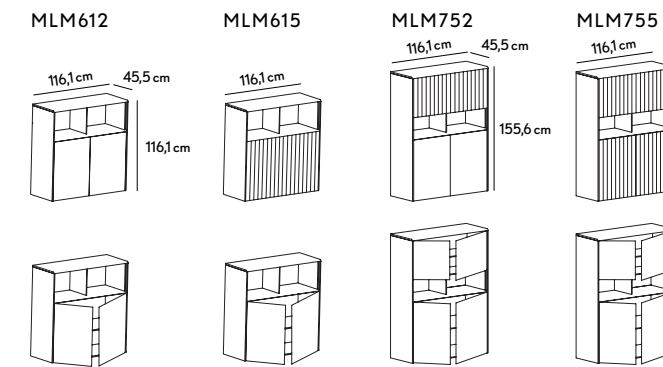

MALMÖ CHEST OF DRAWERS. CÓMODA.

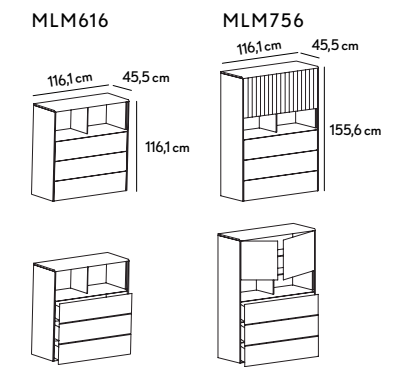

MALM MIRROR. ESPEJO.

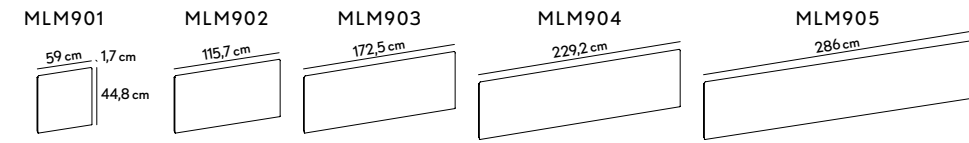

FRONT AND TOP PANELS. FRENTES Y TAPA SUPERIOR

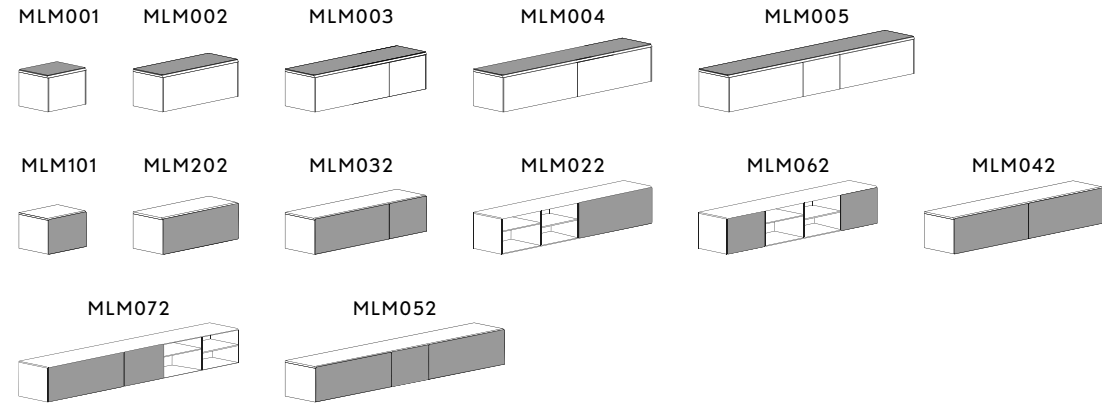

METAL BASE. ZÓCALO

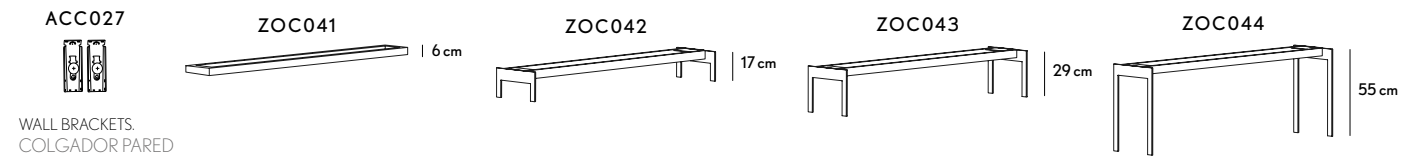

WALL BRACKETS.
COLGADOR PARED

CHICAGO

Norm Architects. 2020

CHICAGO GLASS. CHICAGO VIDRIO

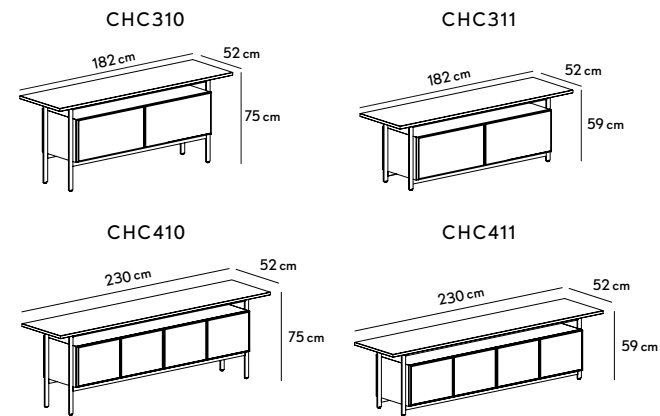

CHICAGO WOOD. CHICAGO MADERA

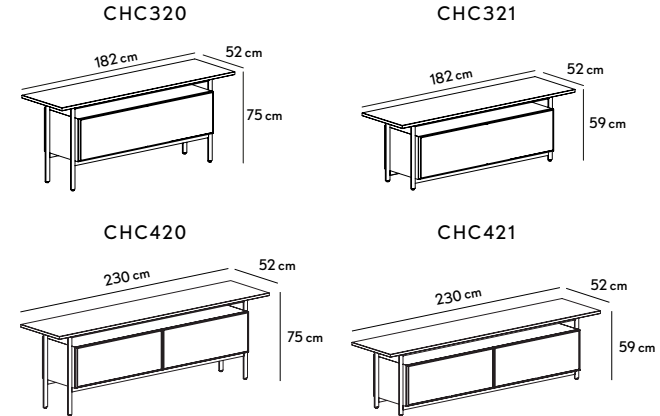

STOCKHOLM

Mario Ruiz. 2012

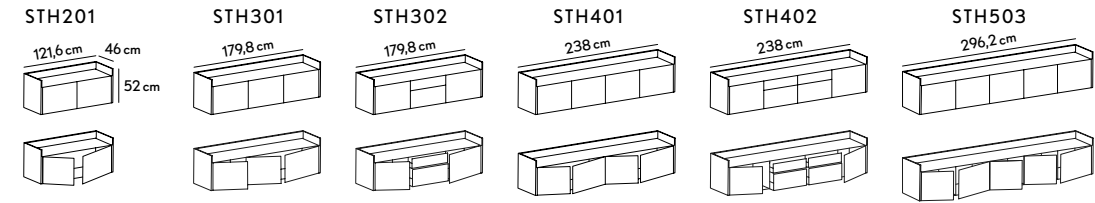

STOCKHOLM TECHNIC

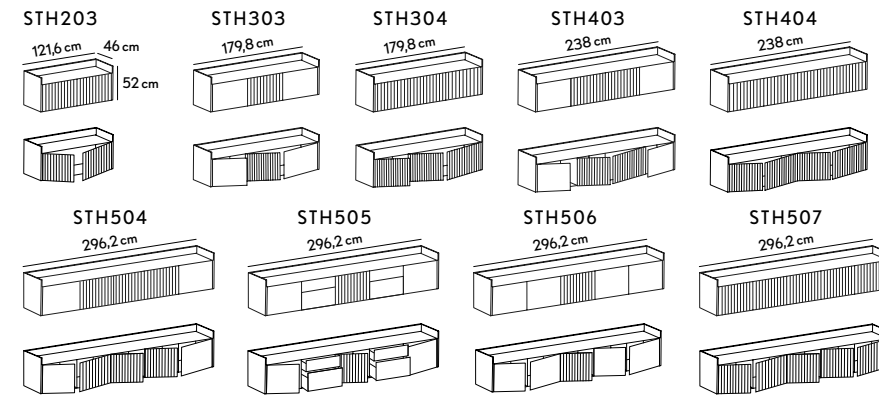

STOCKHOLM SLIM

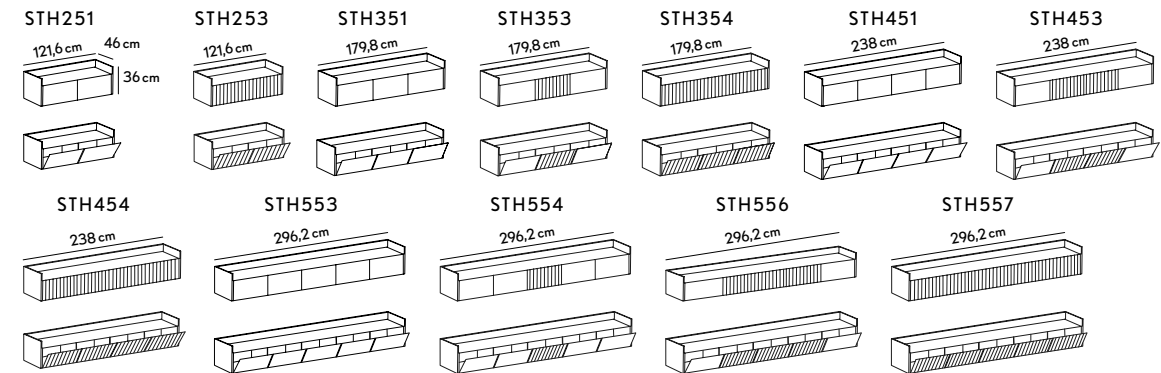

STOCKHOLM BEDSIDE. MESITA DE NOCHE

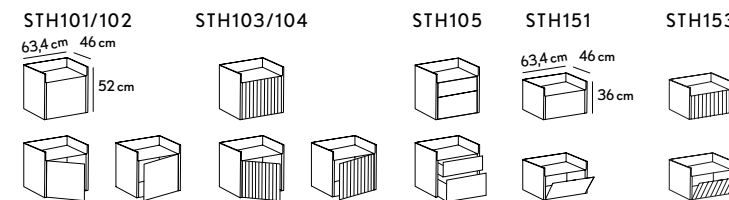

STOCKHOLM DESK. ESCRITORIO

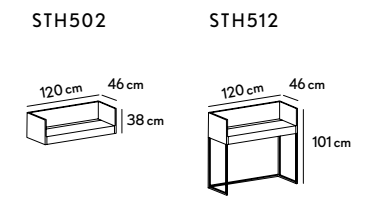

STOCKHOLM CHEST OF DRAWERS. CÓMODA

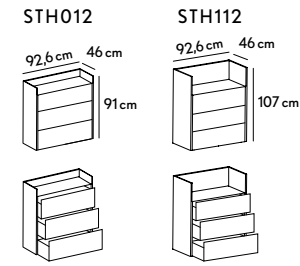

STOCKHOLM CUPBOARD. ALACENA

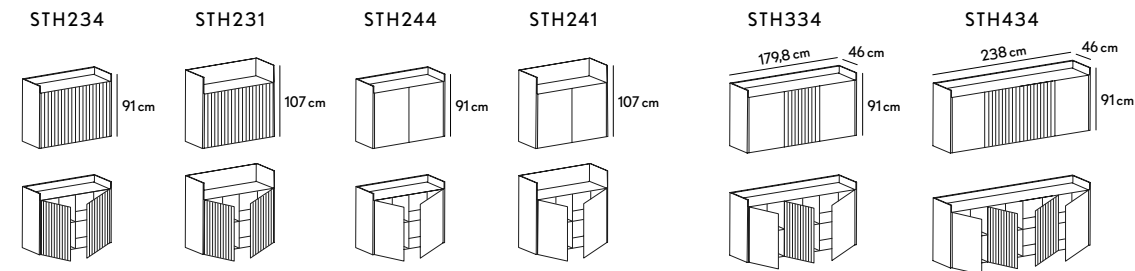
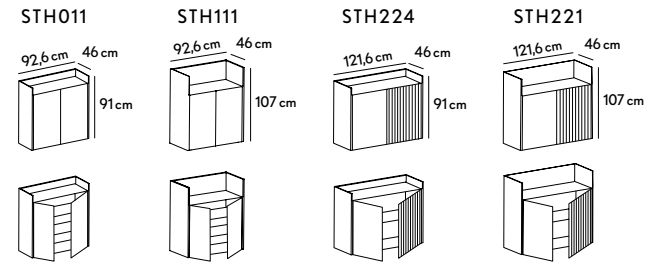

METAL BASE. ZÓCALO

ACC027



WALL BRACKETS. COLGADOR PARED

SLATS

Marc Krusin. 2013



SUSSEX

Terence Woodgate. 2000

SUSSEX BEDSIDE

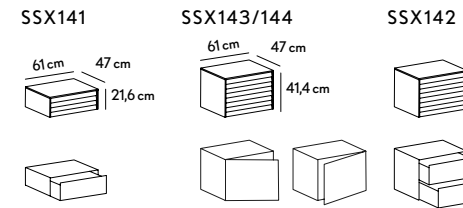

Compositions with doors and drawers. Composiciones con puertas y cajones.

SUSSEX SLIM

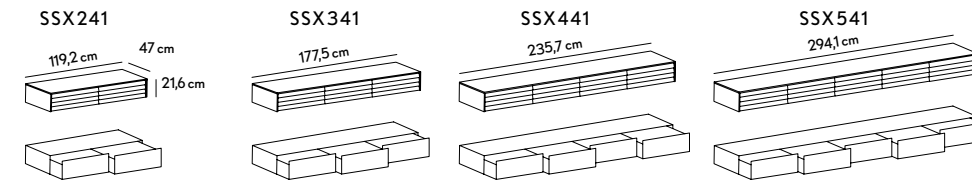

Compositions with drawers. Composiciones con cajones.

SUSSEX 8

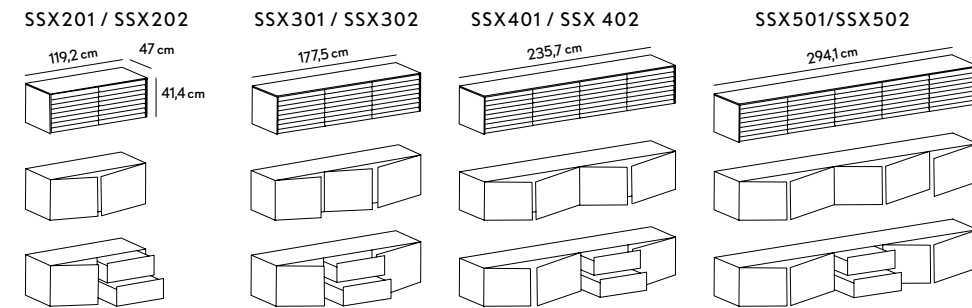

Compositions with doors or doors and drawers. Composiciones con puertas o puertas y cajones.

SUSSEX 12

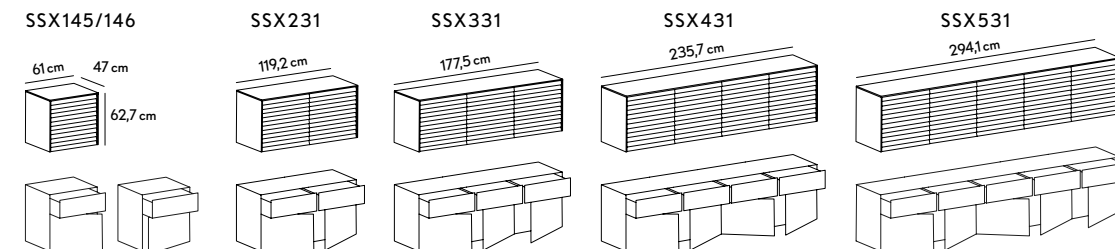

Compositions with doors and drawers. Composiciones con puertas y cajones.

SUSSEX CUPBOARD
SSX147/148

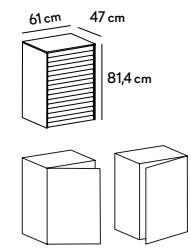

SSX221

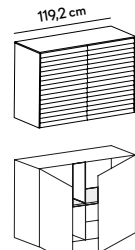

SSX321

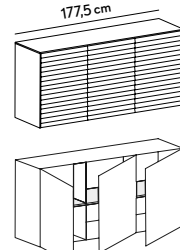

SSX421

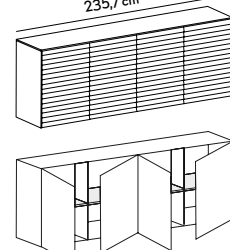

SSX521

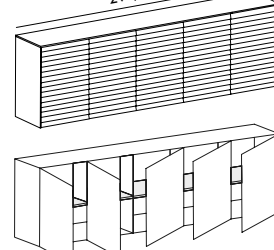

Compositions with doors. Composiciones con puertas.

METAL BASE. ZÓCALO

ACC027



WALL BRACKETS.
COLGADOR PARED

ZOC500

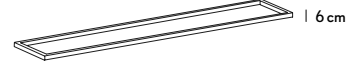

ZOC350

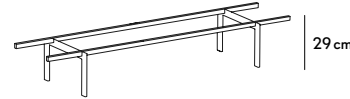

ZOC450



TACTILE

Terence Woodgate. 2007

TAC210

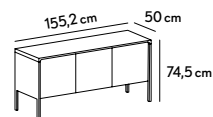

TAC211



TAC215

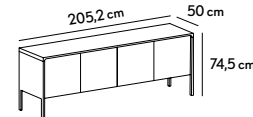

TAC216

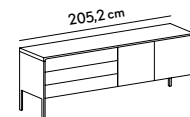

Door units include a shelf. Los módulos de puertas incluyen estante.

LITERATURA OPEN

Vicent Martínez. 2014

BOOKCASE. LIBRERÍA

- | | | | | | |
|--------|--------|--------|--------|--------|--------|
| LOP210 | LOP201 | LOP220 | LOP202 | LOP230 | LOP221 |
| LOP410 | LOP401 | LOP420 | LOP402 | LOP430 | LOP421 |
| LOP510 | LOP501 | LOP520 | LOP502 | LOP530 | LOP521 |

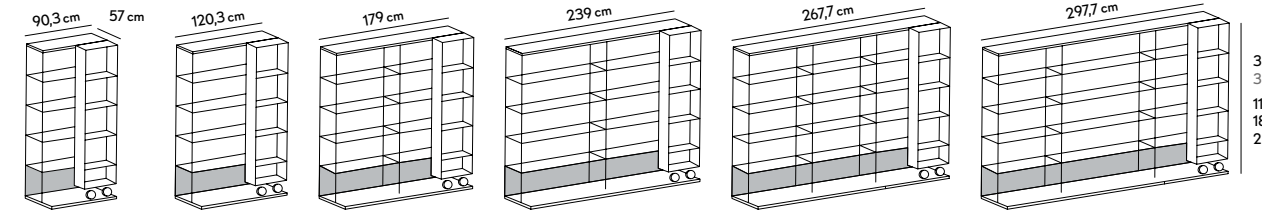

3 available heights.
3 alturas disponibles.
117 cm
189,5 cm
225,6 cm

AVAILABLE. DISPONIBLE. Bookcase total depth 35,5 cm without elements on wheels. Estantería de fondo total 35,5 cm sin carro sobre ruedas.

TV MODEL. MÓDULO TV

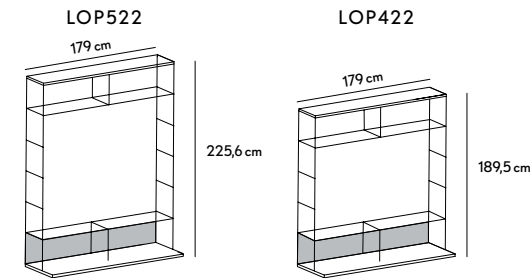

ELEMENTS ON WHEELS. CARROS

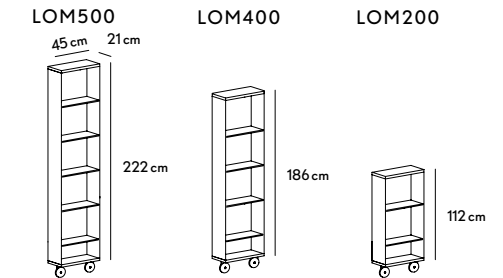

BACK PANEL. PANEL TRASERO

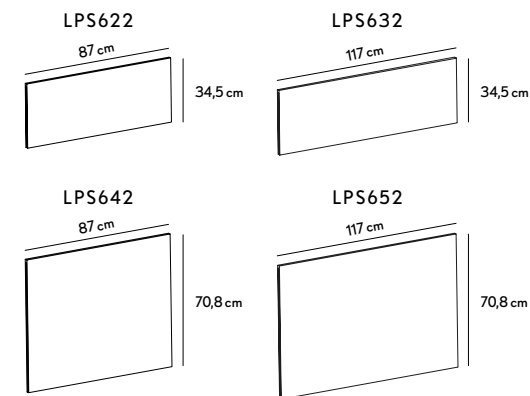

SIDE PANEL. PANEL LATERAL

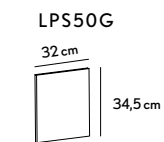

CROSSPIECES. CRUCETAS

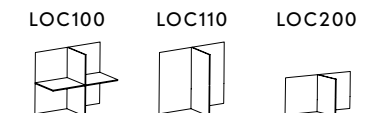

STORAGE MODULES. MÓDULOS CONTENEDORES

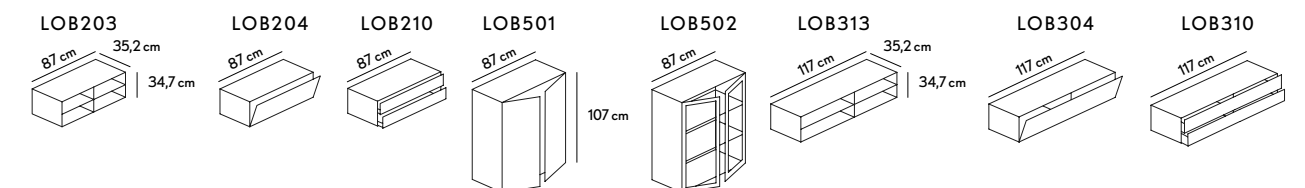

SIDEBOARD 76,5. APARADOR 76,5

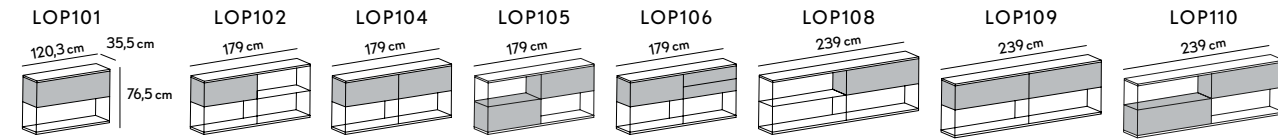

SIDEBOARD 54. APARADOR 54

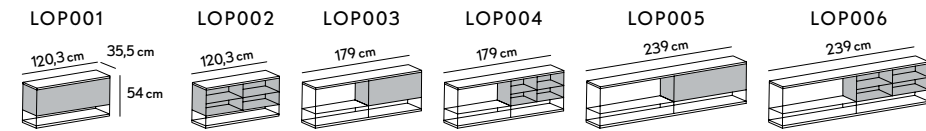

SIDEBOARD 75. APARADOR 75

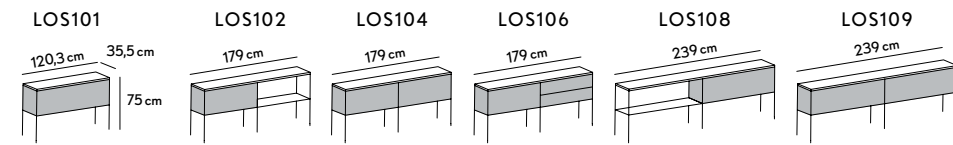

SIDEBOARD 52,5. APARADOR 52,5

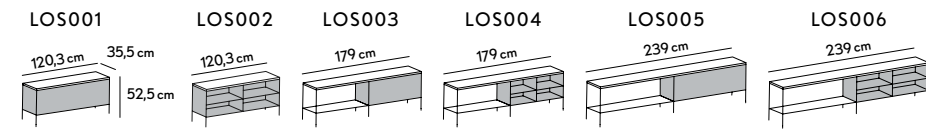

LITERATURA SELECTION

Vicent Martínez. 2020

SIDEBOARD 75. APARADOR 75

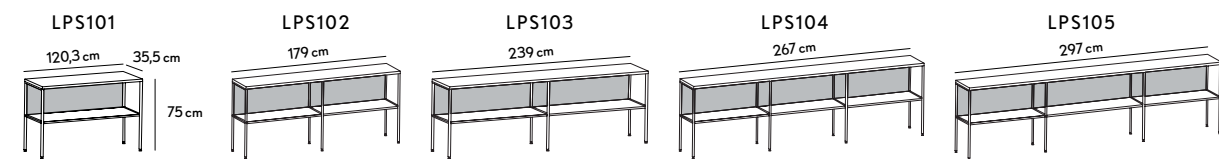

SIDEBOARD 52,5. APARADOR 52,5

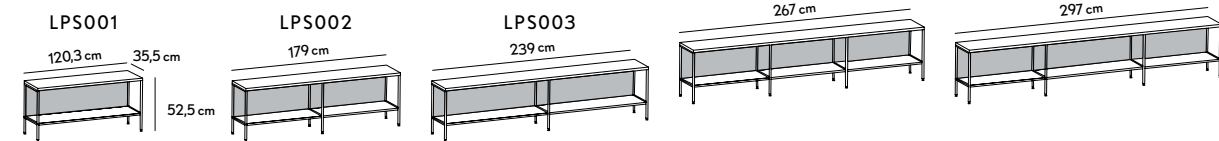

The back panels can be replaced by other references (storage modules). Las traseras pueden reemplazarse por otras referencias (módulos contenedores).

LITERATURA SELECTION

Vicent Martínez. 2020

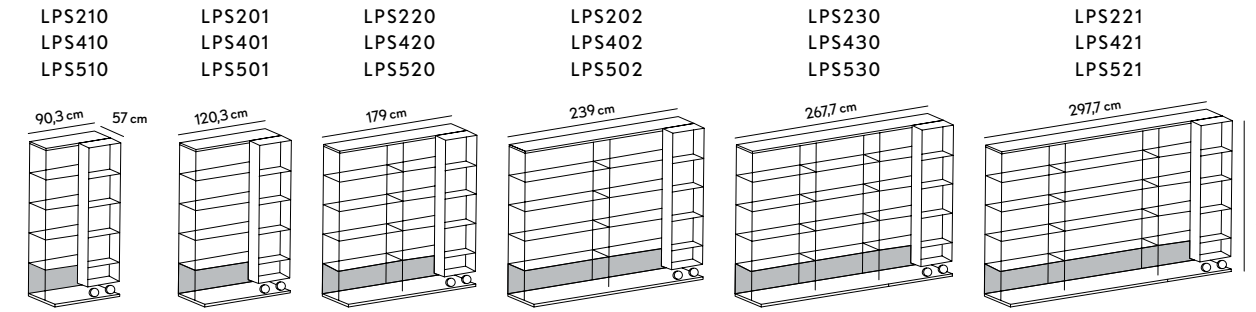

3 available heights.
3 alturas disponibles.
117 cm
189,5 cm
225,6 cm

AVAILABLE. Bookcase total depth 35,5 cm without elements on wheels. DISPONIBLE. Estantería de fondo total 35,5 cm sin carro sobre ruedas.

TV MODEL. MÓDULO TV

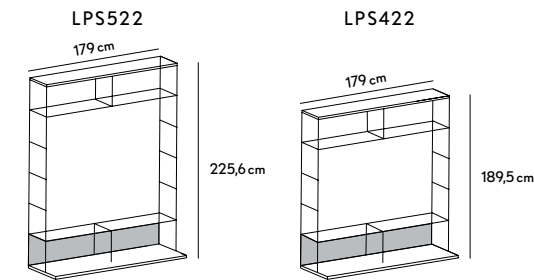

ELEMENTS ON WHEELS. CARROS

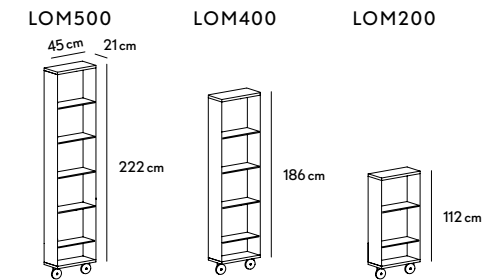

BACK PANEL. PANEL TRASERO

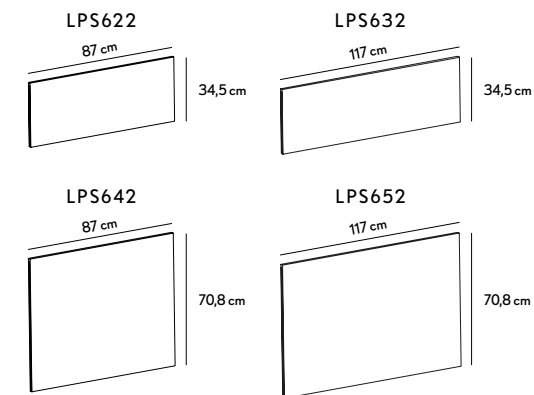

SIDE PANEL. PANEL LATERAL



Not removable. No desmontables.

CROSSPIECES. CRUCETAS

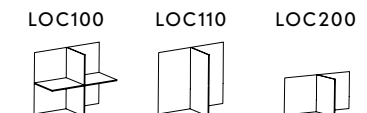

STORAGE MODULES. MÓDULOS CONTENEDORES

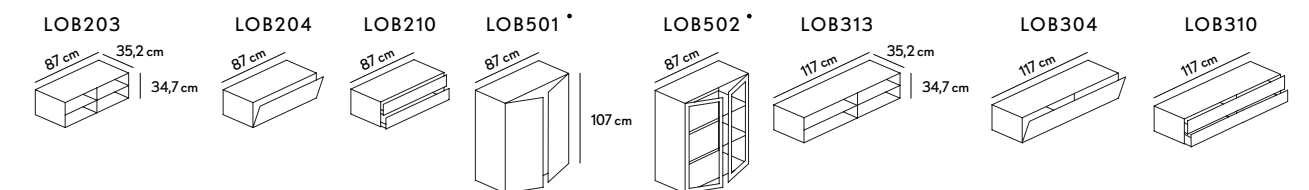

SIDEBARD 76,5. APARADOR 76,5

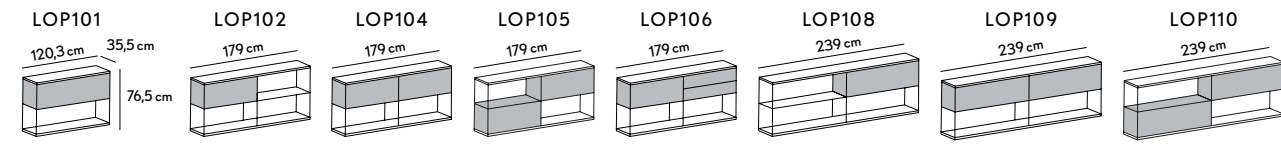

SIDEBARD 54. APARADOR 54

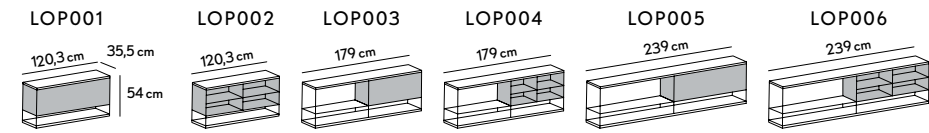

SIDEBARD 75. APARADOR 75

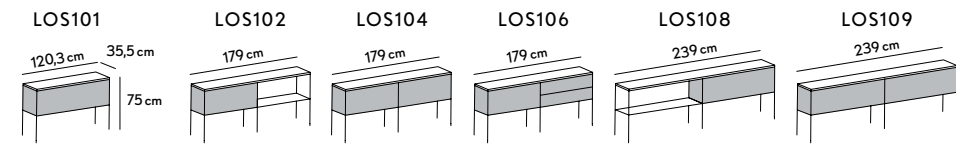

SIDEBARD 52,5. APARADOR 52,5

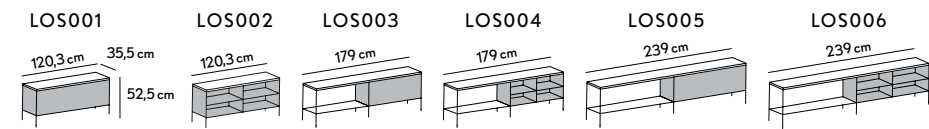

LITERATURA CLASSIC

Vicent Martínez. 1985

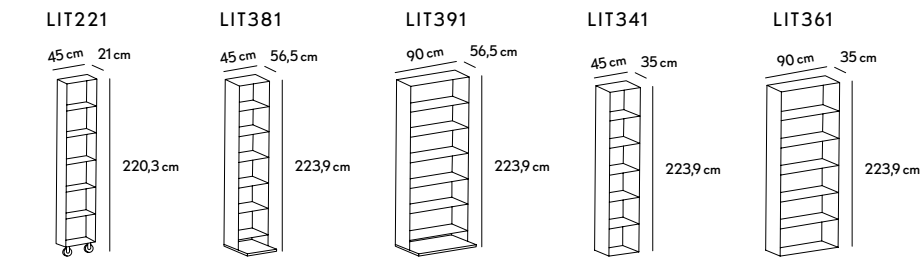

GIN

Terence Woodgate. 2016

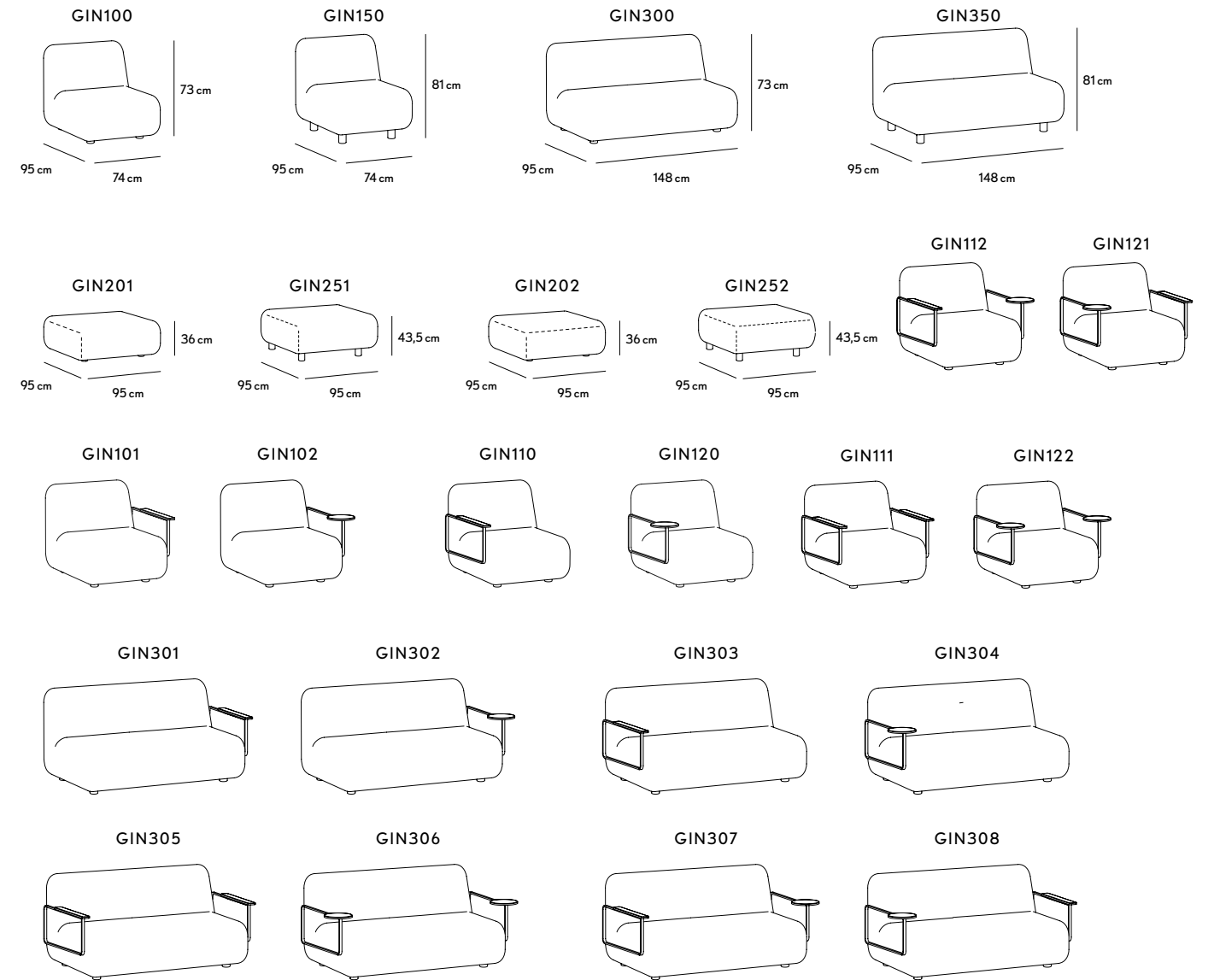

AMOR CORTESE

Monica Armani. 2016

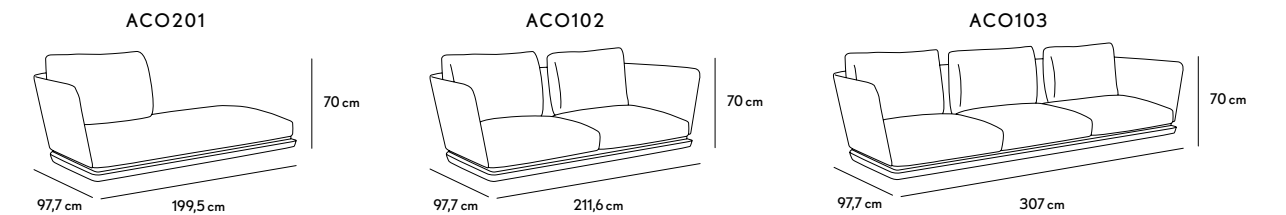

HUG

Estudi Manel Molina. 2018

HUG101 / HUG201 / HUG301

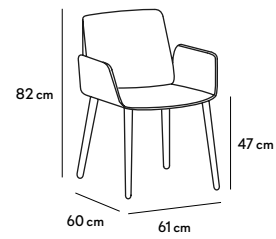

HUG104 / HUG204 / HUG304

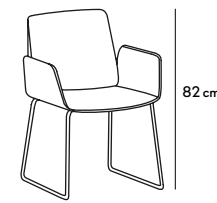

HUG103 / HUG203 / HUG303

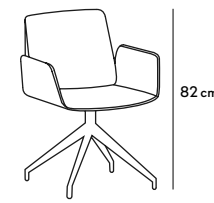

HUG105 / HUG205 / HUG305

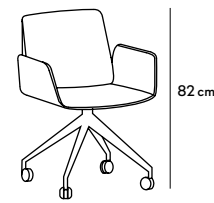

HUG106 / HUG206 / HUG306

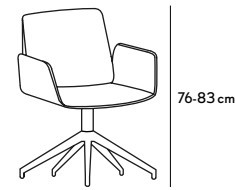

HUG107 / HUG207 / HUG307

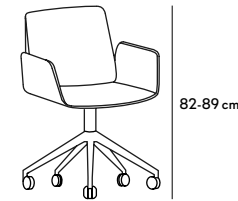

TYRIS

Odosdesign. 2016

TYR101

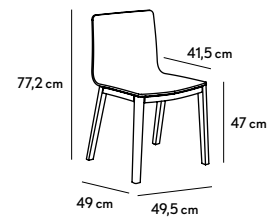

TYR201 / TYR211 / TYR221



TYR202 / TYR212 / TYR222

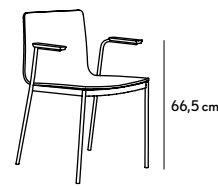

BREDA

Borja García. 2013

BRD101

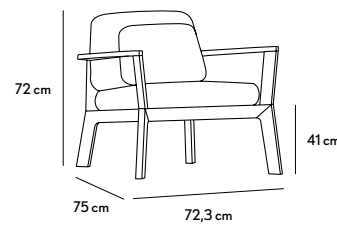

BRD202

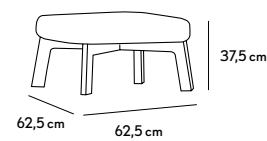

ARMREST COVER. CUBRE BRAZO

BRA101

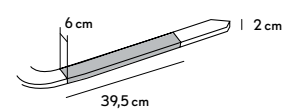

MAVA

Stephanie Jasny. 2013

MAV100

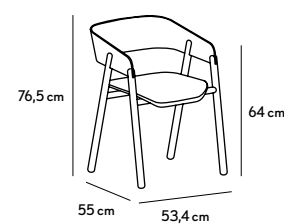

MAV101



MAV102



HPW

Punt team. 2020

HPW111

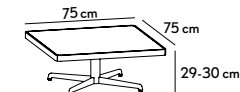

HPW112

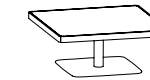

HPW123

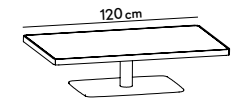

HPW211

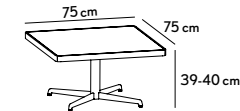

HPW212

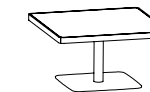

HPW223

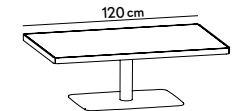

HPW311

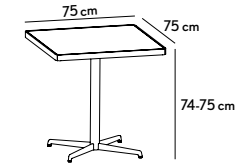

HPW312



HPW323

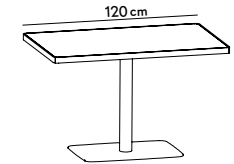

STOCKHOLM TABLE

Mario Ruiz . 2020

STM100

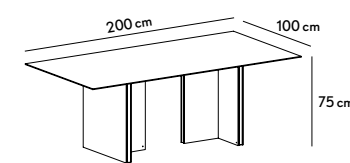

STM200

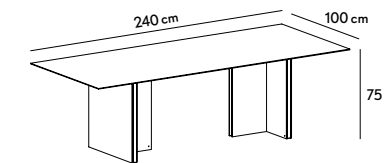

STM300

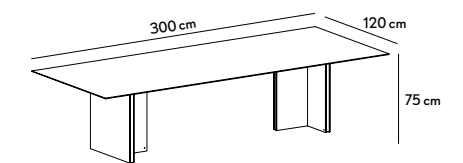

STM120

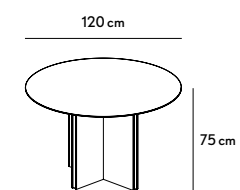

STM140

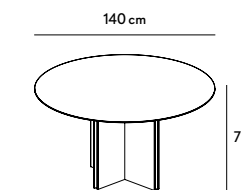

STM160

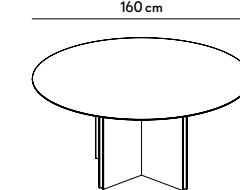

BASS

Borja García.

BAS101

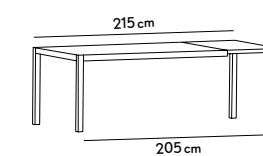
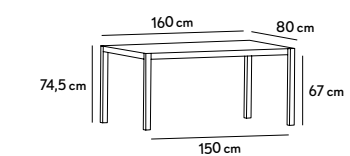

EXTENDABLE TABLE. MESA EXTENSIBLE

MITIS

Mario Ruiz. 2012

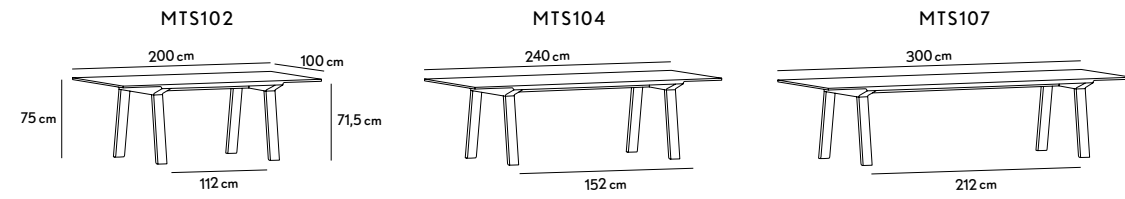

MITIS HIGH. MITIS ALTA

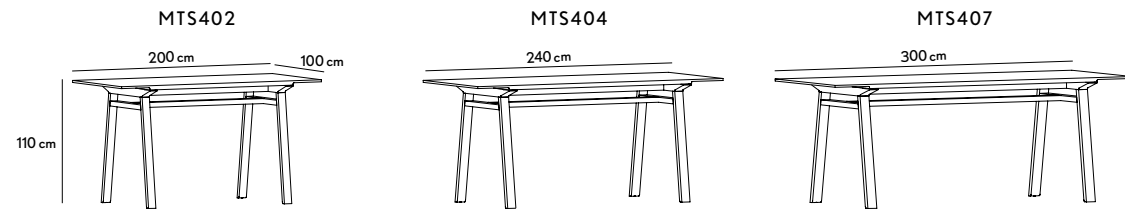

MITIS EXTREM. MITIS EXTREMO

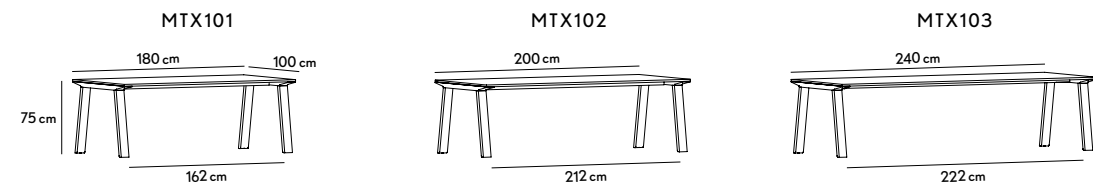

AVAILABLE SPECIAL SIZE. TAMAÑO ESPECIAL DISPONIBLE

NUCLEO

Victor Carrasco. 2012

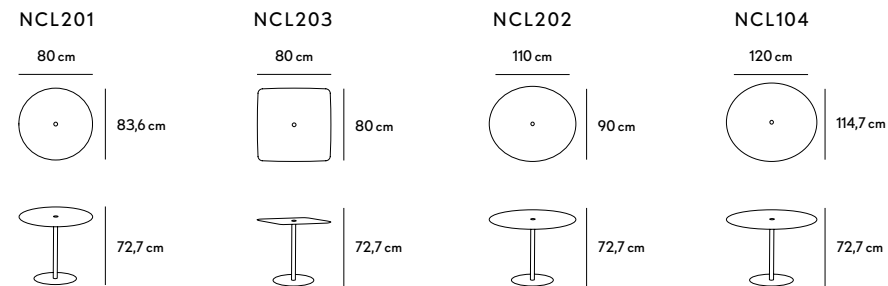

BREDA Low Table

Borja Garcia. 2013

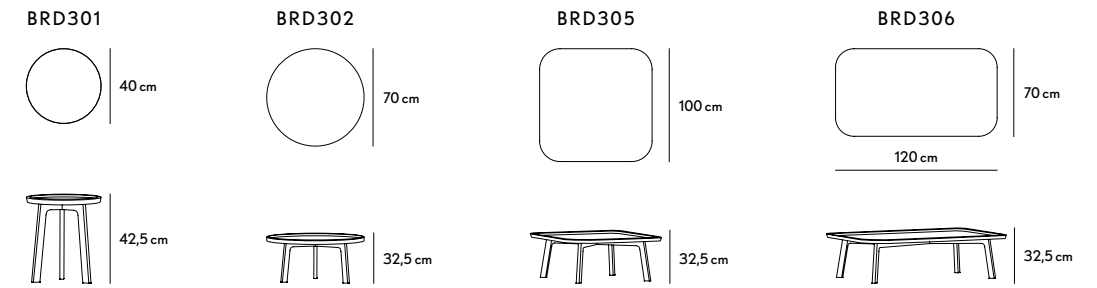

STOCKHOLM Low Table

Mario Ruiz. 2014

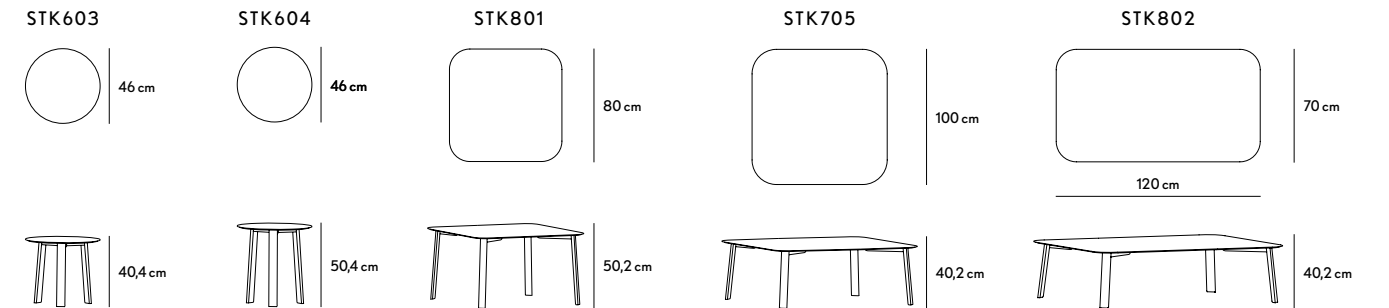

CUATRO

Nathang Yong. 2014

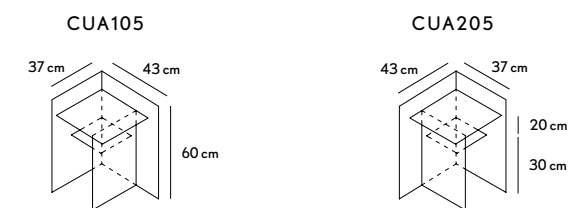

BREDA

Borja Garcia. 2012

BREDA FRAME. BREDA ARO

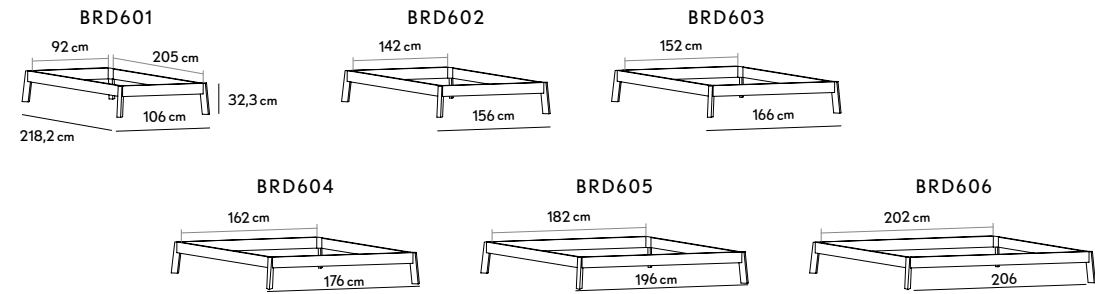

BREDA BED. BREDA CAMA

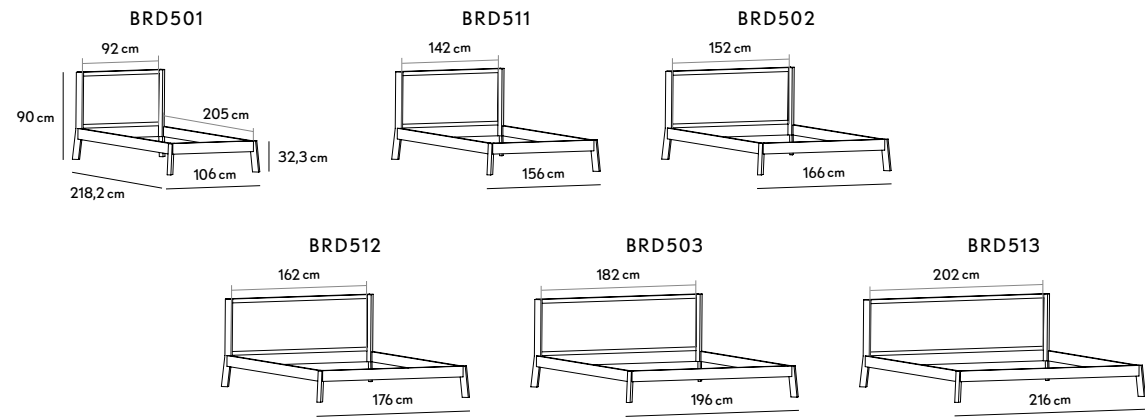

BREDA WITH CANOPY. BREDA DOSEL

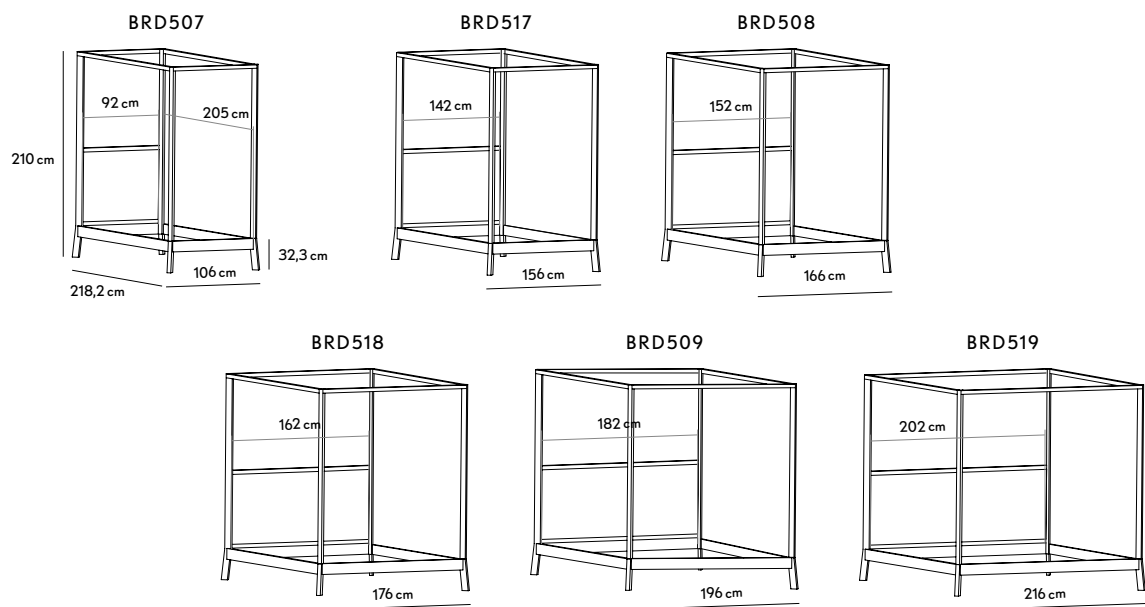

ERNEST

Borja Garcia. 2012

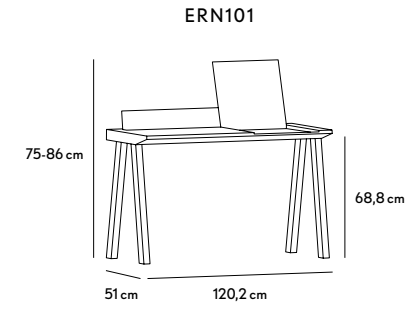

PLATEL

Borja Garcia. 2012

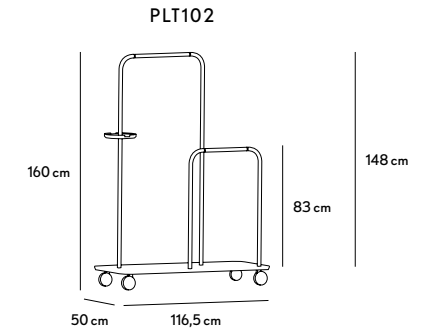

MAI TAI

Odosdesign.2013

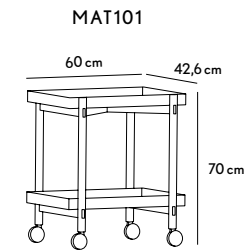

NIDO

J. Martínez Medina. 1964

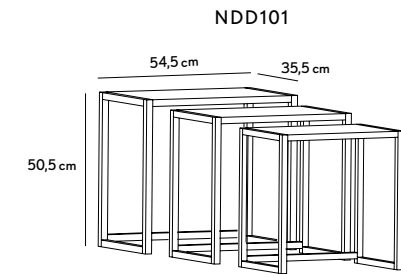

ELX

Vicent Martínez. 1997

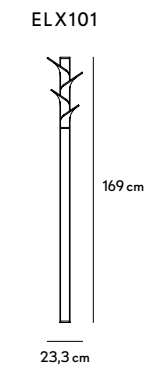

Collections

Search...



Type



SIDEBOARDS

NEW WORKSPACE

CLICK HERE!



CHICAGO WOOD DOORS 



CHICAGO GLASS DOORS 



LITERATURA OPEN SIDEBOARD 53 

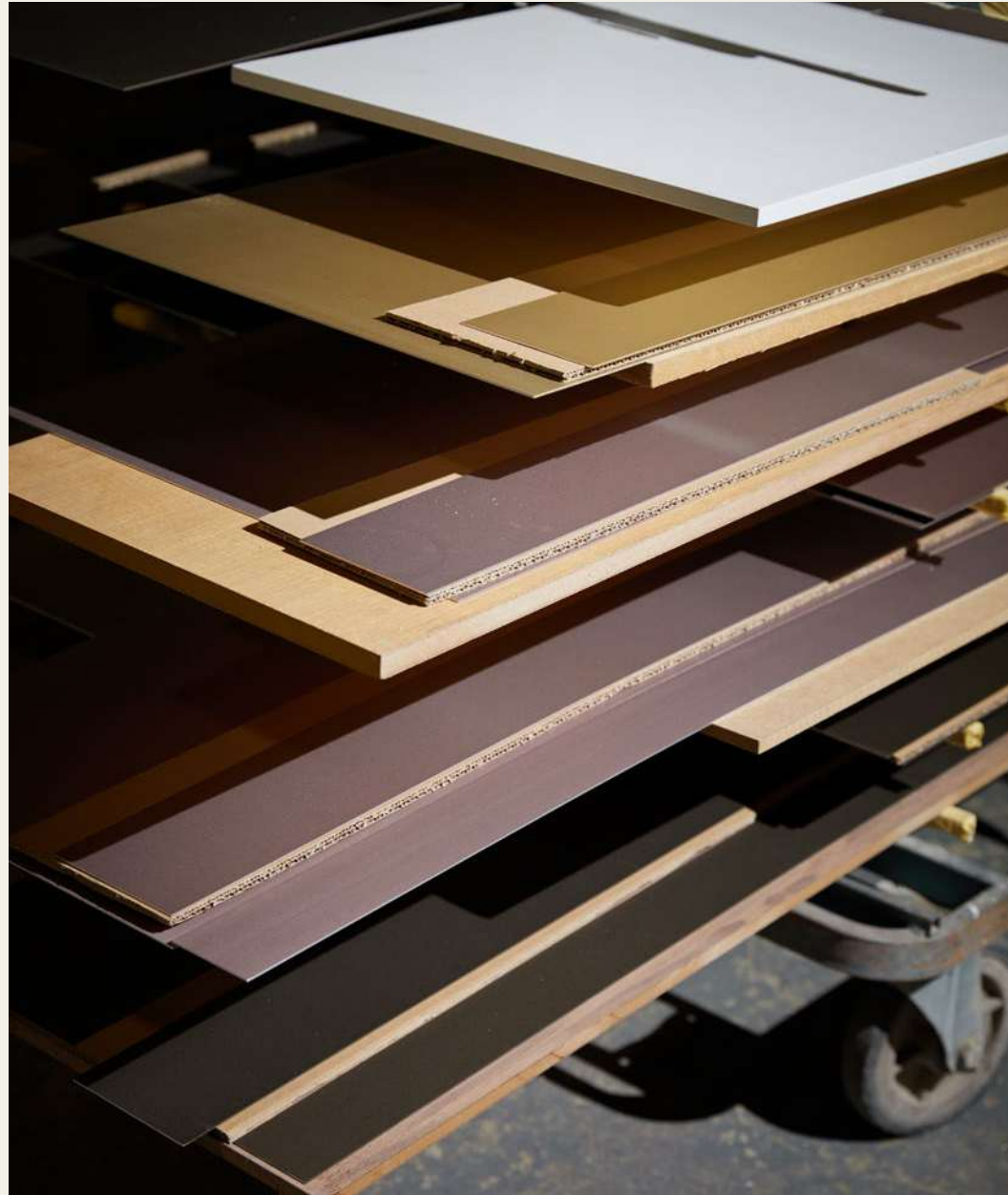

**OUR FINISHES /
NUESTROS ACABADOS**

[CLICK HERE!](#)

punt

PROJECTS

[CLICK HERE!](#)





VIRTUAL SHOWROOM

CLICK HERE!

CREDITS

ART DIRECTOR & DESIGN

José Pérez

Special thanks to

Fambuena

Flos

Marset

Now Carpets

Ricardo Cano

Photograph

Ángel Segura

Printing

Logik Graphics

puntmobles.com

©PuntmoblesXXI.S.L B98387327
C/Islas baleares 48, Paterna
46988, Valencia, Spain
info@puntmobles.com