

**Gaber®**

**Seating Collection**

**Gaber®**

# Contract

Designs, develop and production



Gaber designs, develops and produces furniture for the contract world, responding to the needs of design, flexibility and quality thanks to the high level of expertise achieved in the molding of plastics and metal processing. Production efficiency, continuous research and great attention to details make it possible to create practical, versatile and long-lasting furnishing solutions.

The total customization at the service of the world of architecture and design make us the ideal partner to style and furnish different environments, all dedicated to hospitality and therefore to the well-being of people sharing moments of work, meeting and relaxation. Projects in which each product has its strong, distinctive features and is part of a furnishing system designed to interpret evolving needs, new times and new meeting places.

Gaber progetta, sviluppa e produce arredi per il mondo contract rispondendo a esigenze di design, flessibilità e qualità grazie all'altissima expertise raggiunta nello stampaggio di materie plastiche e nella lavorazione del metallo. Efficienza produttiva, ricerca continua e grande attenzione ai dettagli permettono di realizzare soluzioni di arredo pratiche, versatili e durature.

La totale customizzazione al servizio del mondo dell'architettura e del design ci rendono il partner ideale per arredare diversi ambienti, tutti orientati all'hospitality e quindi al benessere di persone che condividono momenti di lavoro, di incontro e di relax. Progetti in cui ogni prodotto ha un forte carattere distintivo e si inserisce in un sistema di arredo studiato per interpretare esigenze in divenire, nuovi tempi e nuovi luoghi di incontro.

# Made in Italy

As pure expression of Made in Italy, Gaber interprets that balance between craftsmanship and industry by creating furnishings able of satisfying the tastes and needs of its international audience, with a high level of customization and a wide range of finishes.

Pura espressione del Made in Italy, Gaber interpreta quell'equilibrio tra artigianato e industria che si realizza in arredi capaci di soddisfare gusti ed esigenze di un pubblico internazionale, con un alto livello di personalizzazione e ampia gamma di finiture.



# COVERINGS & finishes

Coverings and finishes stimulate and impact on the senses: they are decorations, textures and patterns. Research, technology and developments assist Gaber® in the production of new emotional tactile feelings on surfaces made for Interior Design. This is the place where your products are born.

Rivestimenti e finiture superficiali suscitano emozioni e sollecitano i sensi: che si tratti di decori, texture o trame. Ricerca, sperimentazione e tecnologia aiutano Gaber® nella produzione di nuovi effetti tattili ed emozionali per le superfici destinate all'Interior Design. Questo è il posto dove nascono i vostri prodotti.



#keepdreaming on gaber.it

## CONTENTS / INDICE CHAIRS

ABUELA  
Favaretto & Partners  
P. 28



BIG BANG  
Stefano Sandonà  
Sabrina Bettini  
P. 140



AKAMI  
Stefano Sandonà  
P. 74



BLOG  
Stefano Sandonà  
P. 142



ALHAMBRA  
Stefano Sandonà  
P. 128



CHEVALET  
Favaretto & Partners  
P. 112



AVENICA  
Studio Eurolinea  
P. 176



CHOPPY  
Favaretto & Partners  
P. 46



BAKHITA  
Studio Eurolinea  
P. 58



CHOPPY SLEEK  
Favaretto & Partners  
P. 48



BASKET  
Alessandro Busana  
P. 108



CLIPPERTON  
Marc Sadler  
P. 50



CHAIRS

CLIPPERTON BLEND  
Marc Sadler  
P. 52



ELODIE  
Marc Sadler  
P. 70



COLORFIVE  
Stefano Sandonà  
P. 120



EPICA  
Marc Sadler  
P. 54



COMPACT  
Studio Eurolinea  
P. 152



EXTREME  
Stefano Sandonà  
P. 126



CONGA SOFÀ  
Studio Eurolinea  
P. 174



FINFERLO  
Favaretto & Partners  
P. 114



CUCARACHA  
Favaretto & Partners  
P. 66



FLAP  
Studio Eurolinea  
P. 150



CUCARACHA SLIM  
Favaretto & Partners  
P. 68



FULLER  
Marc Sadler  
P. 34



CHAIRS

GRAND MINUSH  
Studio Eurolinea  
P. 172



KANVAS  
Stefano Sandonà  
P. 94



HARMONY  
Studio Eurolinea  
P. 189



KANVAS 2  
Stefano Sandonà  
P. 92



IRIS  
Studio Eurolinea  
P. 190



KANVAS LOUNGE  
Stefano Sandonà  
P. 100



CONGA SOFÀ  
Studio Eurolinea  
P. 174



FINFERLO  
Favaretto & Partners  
P. 114



ISIDORA  
Favaretto & Partners  
P. 62



LILÀ  
Studio Eurolinea  
P. 191



CUCARACHA  
Favaretto & Partners  
P. 66



FLAP  
Studio Eurolinea  
P. 150



JUBEL  
Forsix  
P. 90



LINK  
Stefano Sandonà  
P. 162



CUCARACHA SLIM  
Favaretto & Partners  
P. 68



FULLER  
Marc Sadler  
P. 34



KALIPA  
Studio Eurolinea  
P. 136



MANAA  
Studio Eurolinea  
P. 38



CHAIRS

MANAA SLIM  
Studio Eurolinea  
P. 42



OVER  
Studio Eurolinea  
P. 148



MINUSH  
Studio Eurolinea  
P. 170



PANAMA  
Stefano Sandonà  
P. 178



MOEMA  
Stefano Sandonà  
P. 116



PLACE  
Favaretto & Partners  
P. 182



MOON - VENEZIA  
Studio Eurolinea  
P. 146 - 147



PRISMA  
Studio Eurolinea  
P. 154



MORE  
Favaretto & Partners  
P. 102



PRODIGE  
Giampaolo Allocco  
P. 104



NUTA  
Favaretto & Partners  
P. 26



SLOT  
Favaretto & Partners  
P. 80



CHAIRS

SLOT FILL  
Favaretto & Partners  
P. 78



TERRASSE  
Marc Sadler  
P. 188



SOCIAL-IZE  
Studio Eurolinea  
P. 186



TOGETHER  
Marc Sadler  
P. 156



SPYKER  
Studio Eurolinea  
P. 166



SUNLOUNGER DOGE  
Forsix  
P. 158



SUNLOUNGER PODIO  
Forsix  
P. 160



TECKEL  
Studio Eurolinea  
P. 72



STOOLS

ABUELA  
Favaretto & Partners  
P. 30



CITRO  
Studio Eurolinea  
P. 205



STOOLS

FREE  
Studio Eurolinea  
P. 199



JOY  
Studio Eurolinea  
P. 206



AKAMI  
Stefano Sandonà  
P. 76



COLORFIVE  
Stefano Sandonà  
P. 124



FREEDOM  
Stefano Sandonà  
P. 197



JUBEL  
Forsix  
P. 92



ALHAMBRA  
Stefano Sandonà  
P. 132



CROSS  
Studio Eurolinea  
P. 208



FULLER  
Marc Sadler  
P. 36



KALIPA  
Studio Eurolinea  
P. 138



ASOLO  
Studio Eurolinea  
P. 203



EASY  
Studio Eurolinea  
P. 207



GULIVER  
Studio Eurolinea  
P. 199



KANVAS  
Stefano Sandonà  
P. 96



BAKHITA  
Studio Eurolinea  
P. 60



FIX  
Studio Eurolinea  
P. 206



ISIDORO  
Favaretto & Partners  
P. 64



LILÀ  
Studio Eurolinea  
P. 198



BLOG  
Stefano Sandonà  
P. 144



FORMAT  
Studio Eurolinea  
P. 194



JIMMY  
Studio Eurolinea  
P. 209



LINK  
Stefano Sandonà  
P. 166



STOOLS

MANAA  
Studio Eurolinea  
P. 40



OFER  
Studio Eurolinea  
P. 210



STOOLS

SHIVER  
Studio Eurolinea  
P. 195



SWING - TORINO  
Stefano Sandonà  
P. 200 - 201



MANAA SLIM  
Studio Eurolinea  
P. 44



OVER  
Studio Eurolinea  
P. 204



SLOT  
Favaretto & Partners  
P. 88



TOM  
Studio Eurolinea  
P. 206



MICRO  
Studio Eurolinea  
P. 202



PANAMA  
Stefano Sandonà  
P. 180



SLOT FILL  
Favaretto & Partners  
P. 86



ACCESSORIES

MOEMA  
Stefano Sandonà  
P. 118



POP  
Stefano Sandonà  
P. 198



SNACK  
Studio Eurolinea  
P. 205



FLAIRE  
P. 211



MORE  
Favaretto & Partners  
P. 102



PRODIGE  
Giampaolo Allocco  
P. 106



SPYKER  
Studio Eurolinea  
P. 168



LUX  
P. 212



OCTO  
Stefano Sandonà  
P. 196



ROLLER  
Studio Eurolinea  
P. 192



SQUARE  
Studio Eurolinea  
P. 204















































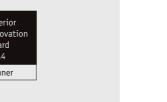

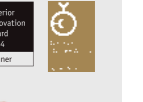
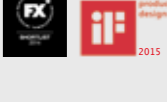



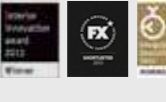



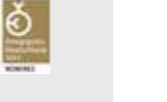

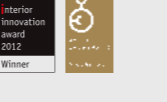





COLORS  
AND  
FINISHES  
P. 213



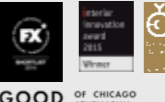
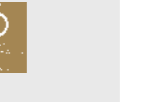

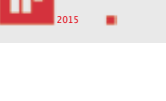
# AWARDS: SUCCESS IN PROGRESS

Gaber has won prestigious awards in the field on safety and design. These recognitions are a testament to Gaber's unstinting commitment to design and the focus on originality and innovation we bring to the world.  
Gaber ha vinto prestigiosi premi in ambito di sicurezza e design. Questi riconoscimenti testimoniano il nostro continuo impegno nella progettazione e il focus in originalità e innovazione che portiamo nel mondo.

 <p><b>MAGIC</b> 2003 Studio Eurolinea Design</p> 	 <p><b>OVER</b> 2004 Studio Eurolinea Design</p> 	 <p><b>PRISMA</b> 2005 Studio Eurolinea Design</p> 	 <p><b>PRODIGE</b> 2007 Delineo Design</p> 	 <p><b>JOE</b> 2011 Stefano Sandonà</p> 	 <p><b>COLORFIVE</b> 2011 Stefano Sandonà</p> 	 <p><b>TOGETHER</b> 2011 Marc Sadler</p> 	 <p><b>BLOG chair and stool</b> 2012 Stefano Sandonà</p> 
 <p><b>FLOWER</b> 2008 Laura Tombari</p> 	 <p><b>SPRING</b> 2008 Monica Graffeo</p> 	 <p><b>EXTREME</b> 2009 Stefano Sandonà</p>   	 <p><b>MOEMA chair and stool</b> 2009 Stefano Sandonà</p>  	 <p><b>OCTO</b> 2012 Stefano Sandonà</p>  	 <p><b>MORE</b> 2012 Favaretto &amp; Partners</p>  	 <p><b>PANAMA chair and stool</b> 2013 Stefano Sandonà</p>  	 <p><b>AKAMI</b> 2013 Stefano Sandonà</p>   
 <p><b>ALHAMBRA</b> 2010 Stefano Sandonà</p> 	 <p><b>FREEDOM</b> 2010 Stefano Sandonà</p>   	 <p><b>BIG BANG</b> 2011 Stefano Sandonà Sabrina Bettini</p>  	 <p><b>MOEMA wood</b> 2011 Stefano Sandonà</p>  	 <p><b>SLOT chair and stool</b> 2013 Favaretto &amp; Partners</p>  	 <p><b>CHEVALET</b> 2013 Favaretto &amp; Partners</p>   	 <p><b>BASKET CHAIR</b> 2013 Alessandro Busana</p>    	 <p><b>EPICA</b> 2014 Marc Sadler</p>   

# AWARDS: SUCCESS IN PROGRESS



**STILLY**  
2014  
Studio  
Eurolinea  
Design



**ISIDORO**  
2015  
Favaretto &  
Partners



**ISIDORA**  
2015  
Favaretto &  
Partners



**CHOPPY**  
2015  
Favaretto &  
Partners

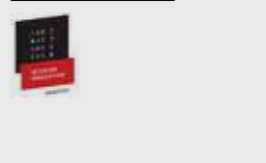

**AVENICA**  
2016  
Studio  
Eurolinea  
Design



**PLACE**  
2016  
Favaretto &  
Partners



**DIAMANTE**  
2016  
Studio  
Eurolinea  
Design

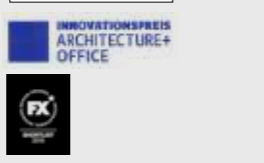

**ELODIE**  
2016  
Marc  
Sadler



**CLIPPERTON**  
2017  
Marc  
Sadler



**ABUELA**  
2018  
Favaretto &  
Partners

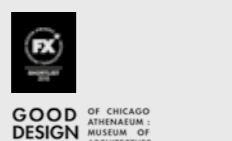

**JUBEL**  
2019  
Forsix  
Design



# IN THE natural RESPECT

Gaber® boasts 20 years experience in the field of furniture design and production, enabling the realization of innovative products that take into account both human and environmental safety. Since 2000 Gaber® has avoided the use of pollutants and has instead encouraged the use of the most valued recycled materials. Gaber® careful launch on the market products complying with the environmental laws in the complete respect of the rules and it promotes the prevention of environmental pollution.

Safeguarding the environment and a continual search for eco-compatible solutions play an important role within our company where, in recent years, all new launches have been designed and manufactured with respect for our natural environment. This begins with the separate disposal of waste in both offices and on the factory floor: paper, cardboard, plastics, packaging, metal and glass are all separated out and recycled in other internal or external industrial processes and it continues up to the independent energy production, thanks to the latest generation of photovoltaic systems.

Gaber regularly undergoes checks by the authorities in line with European Requirements concerning employment, staff training, health and safety, insurance.

Gaber® vanta 20 anni di esperienza nel settore della progettazione e produzione di complementi d'arredo di design, permettendo la realizzazione di prodotti innovativi che tengano sempre conto della sicurezza umana e ambientale. Sin dall'anno 2000, Gaber® ha evitato l'uso di sostanze inquinanti e ha invece incoraggiato l'uso dei più apprezzati materiali riciclati. Gaber®, sempre attenta al lancio sul mercato di prodotti conformi alle più severe leggi di salvaguardia dell'ambiente, promuove a tutti i livelli la prevenzione dell'inquinamento ambientale.

La salvaguardia dell'ambiente e la continua ricerca di soluzioni eco-compatibili, giocano un ruolo importante all'interno della nostra azienda, dove tutti i nuovi prodotti sono progettati e realizzati nel più attento rispetto del nostro ambiente naturale. Tutto ciò inizia con lo smaltimento separato dei rifiuti negli uffici e nelle aree produttive: carta, cartone, plastica, imballaggi, metallo e vetro sono accuratamente separati e riciclati grazie a processi industriali sia interni che esterni e continua sino alla produzione autonoma di energia grazie ad impianti fotovoltaici di ultima generazione.

Grazie al nostro costante impegno, Gaber®, soggetta a regolari controlli da parte delle autorità competenti, si dimostra costantemente in linea con i requisiti Europei in materia di occupazione, formazione, salute e sicurezza.



# FUNCTION **design** AND SUSTAINABILITY



Gaber® production employs exclusively high-tech thermoplastic materials, which are 100% recyclable. Gaber® produces plastic injected materials without added chemicals. These materials are purchased within the European Union, so Gaber® is exempted from registration with ECHA agency (European Agency for Chemicals Substances), in the complete respect of "Reach Regulation". As far as possible, recycled plastics are sourced as a base raw material, recovered post-consumption. The production waste is used, by Gaber®, as secondary raw material in order to manufacture different products in which aesthetic requirements are not important. Each techno-polymer item is marked with a specific symbol, which identifies the kind of polymer for a quick identification and a consequent recycling. Metallic materials are an important part of Gaber® products: these materials are used on the production of chairs, stools and tables.

La produzione Gaber® impiega esclusivamente materiali termoplastici altamente innovativi, riciclabili al 100%. Gaber® produce materiali in tecnopolimero iniettato senza aggiunta di sostanze chimiche. Questi materiali sono acquistati all'interno dell'Unione Europea, pertanto Gaber® è esente dalla registrazione presso l'agenzia Echa (Agenzia europea per sostanze chimiche), nel pieno rispetto del "Regolamento Reach". Per quanto possibile, i materiali plastici riciclati vengono acquistati come materia prima di base, recuperati da post-consumo. Gli scarti di produzione vengono utilizzati da Gaber® come materia prima secondaria per produrre manufatti in cui i requisiti estetici non sono importanti. Ogni articolo in tecnopolimero è contrassegnato da un simbolo specifico, che identifica il tipo di polimero per una rapida identificazione ed un conseguente corretto riciclaggio. I materiali metallici sono una parte importante dei prodotti Gaber®: questi materiali sono utilizzati per la produzione di sedie, sgabelli e tavoli.



Gaber® metal structures, in the full respect of our Natural Environment, are available with "trivalent" chroming and painted finishes. Prime-quality special Epoxy powder coating used on Gaber® frames enhance color stability from batch to batch and over time, increasing its corrosion-resistance and achieving excellent resistance to atmospheric agents. Wooden products are manufactured in accordance with the European Regulations in force regarding formaldehyde emissions from wood-based products. Gaber® uses wooden raw materials coming from PEFC chain of custody certified materials. The flexible polyurethane cold-pressed paddings Gaber® uses on its upholstered products do not contain CFC/HCFC (ODP=0: do not contribute the reduction of the atmospheric ozone layer), they are fire-retardant class 1-IM UNI 9175 following European Standards. Gaber® coverings, fabrics and leathers, belong to a wide range of colors and patterns, which are all tested in order to achieve the best performance, among which resistance to abrasion and artificial light. Gaber's range of fabrics are all non-toxic and non-allergenic. Fire-retardant fabrics and eco-leather upholstery are also available.

Le strutture in metallo di Gaber®, nel pieno rispetto del nostro ambiente naturale, sono disponibili con cromature "trivalenti" e finiture verniciate. Lo speciale rivestimento, in polvere epossidica di prima qualità, utilizzato sui telai Gaber®, migliora la stabilità del colore da un lotto all'altro e nel tempo, aumentandone la resistenza alla corrosione e ottenendo un'eccellente resistenza agli agenti atmosferici. I prodotti in legno sono realizzati in conformità con le normative Europee in vigore per quanto riguarda le emissioni di formaldeide da prodotti a base di legno. Gaber® utilizza materie prime in legno provenienti da materiali certificati della catena di custodia PEFC. Le imbottiture in poliuretano flessibile stampate a freddo che Gaber® utilizza sui suoi prodotti imbottiti non contengono CFC / HCFC (ODP = 0: non contribuiscono alla riduzione dello strato di ozono atmosferico), sono ignifughe classe 1-UNI 9175 secondo le vigenti norme Europee. I rivestimenti, i tessuti e le pelli utilizzate da Gaber®, appartengono a una vasta gamma di colori e modelli, tutti testati per ottenere le migliori prestazioni, tra cui la resistenza all'abrasione e alla luce artificiale. La gamma di tessuti Gaber® è completamente atossica e anallergica. Sono disponibili anche tessuti ignifughi e rivestimenti in ecopelle.

# ACOUSTIC materials



Sustainability of Gaber® acoustic systems is accentuated by recyclability, granted by the choice of the support-frame material and the easy maintenance of the various cover systems: both materials 100% recyclable. Gaber® Acoustic Systems use a support-frame made of shock-resistant and anti-static techno-polymer. Moulded medium-density polyester felt is the basic material, coated with a coloured polyester or wool/polyamide fabric. The material is recyclable, sound absorbent, fire resistant, lightweight and durable.

La sostenibilità dei sistemi acustici Gaber® è accentuata dalla riciclabilità, garantita dalla scelta del materiale per il telaio di supporto e dalla facilità di manutenzione delle coperture: entrambi i materiali sono riciclabili al 100%. I sistemi fonoassorbenti utilizzano un telaio realizzato in tecnopolimero antiurto e antistatico. Il feltro modellato in poliestere a media densità è il materiale base, rivestito con tessuto di poliestere o di lana/poliammide, disponibili in varie colorazioni. Il materiale è riciclabile, fonoassorbente, resistente al fuoco, leggero e durevole.

# PACKAGING materials

Corrugated paperboard carton boxes are preferred on packaging as completely recyclable and made with environmentally friendly papers and inks. Packaging is scaled in order to optimize storage and transport requirements, and it is made of 90% recycled and recyclable materials. The optimization of packaging in terms of volume and weight delivers a lower consumption of energy in many forms, helping the environment and a consequent saving on transport costs.

Imballi in cartone ondulato sono preferiti in quanto facilmente riciclabili, oltre che realizzati con carte ed inchiostri ecologici. L'imballaggio viene dimensionato per ottimizzare i requisiti di stoccaggio e di trasporto ed è costituito per il 90% da materiali riciclati e riciclabili. L'ottimizzazione degli imballaggi in termini di volume e peso offre un minor consumo di energia in molte forme, favorendo l'ambiente e un conseguente risparmio sui costi di trasporto.



## Who? I.d. signer



**ALESSANDRO BUSANA**  
Italia

Born in Padova (Italy) in 1977. From Scuola Italiana Design he graduated in industrial design in 1999, continues its path of specialization with workshops for Rollerblade, Fila, Whirlpool, Alfa Romeo, Chicco, Roncato and Alessi. Since 2004 he made creative design, focused on the functionality of the products and attends national and international avantgarde exhibitions, (like The New Italian Design 2007/2010, Nazionale Italiana Design, Openhouse, Wonderful Water World, Made For China, DISCOVERING Temporary Museum of New Design, STUF...JUSTHINGS? Triennale di Milano), and he's published in the most important design magazines. In 2009 he founded "h0le designstudio", a new concept development agency, where creates products for big national and international companies.

Nasce a Padova nel 1977. Nel 1999 si diploma in industrial design presso Scuola Italiana Design, prosegue il suo percorso di specializzazione partecipando a workshop per Rollerblade, Fila, Whirlpool, Alfa Romeo, Chicco, Roncato ed Alessi. Dal 2004 si occupa di progettazione creativa orientata al design di prodotto, partecipa a mostre d'avanguardia in ambito nazionale ed internazionale, (come The New Italian Design 2007/2010, Nazionale Italiana Design, Openhouse, Wonderful Water World, Made For China, DISCOVERING Temporary Museum of New Design, STUF...JUSTHINGS? Triennale di Milano), ed è pubblicato dalle principali riviste di settore. Nel 2009 fonda "h0le designstudio", contenitore di ricerca e sviluppo concept, creando prodotti per importanti aziende in ambito nazionale ed internazionale.

## Spazio alla creatività

Gaber's key designers bring different a variety of experience to the development of concepts and products. Each of them has been able to understand, each with their own sensibility, Gaber character and style.

I designer che collaborano a stretto contatto con Gaber portano diverse esperienze per lo sviluppo di concetti e prodotti. Tutti loro sono stati in grado di comprendere, ognuno con la propria sensibilità, il carattere e lo stile di Gaber.



**FAVARETTO&PARTNERS**  
Italia

Curiosity, unrelenting passion for research and exemplary rigour in design have characterised Favaretto&Partners' work in industrial design and architectural planning for over 30 years. Founded in 1973 as Studio Favaretto, it developed, from the early 80s, a long and fruitful experience working alongside Italian and foreign companies. The practice has consolidated lasting relationships by following the full development process of most projects with a number of prestigious businesses, receiving many awards.

Favaretto&Partners' unique style is founded on the innovative use of materials, painstaking precision in design and a penchant for stylistic and functional inventiveness. The technical competencies gleaned over decades and the ever-present passion for experimentation have enabled the practice to work successfully and with versatility in different manufacturing sectors, from telephones to furnishings (seating, lighting,.....) to medical and household objects. Favaretto&Partners has specialised in the planning, prototyping and production of office furniture, technical seating (operational and executive) and collective systems, introducing, in certain cases, design languages embraced by other designers and manufacturers.

Favaretto&Partners actively supports and adheres to the principles of "Design for All", a declaration accepted by the European Commission and promoted by the I.I.D.D. (Italian Institute Design Disability). The declaration encourages disability-proof design practices which aim to make objects and environments accessible and functional to the widest possible range of users.

Curiosità, rigore e passione per la ricerca caratterizzano da 40 anni il lavoro dello studio Favaretto&Partners, specializzato in industrial design e progettazione architettonica. Fondato nel 1973 come Studio Favaretto ha sviluppato, sin dagli anni '80, una lunga esperienza in Italia e all'estero, consolidando rapporti duraturi con prestigiose realtà produttive, insieme alle quali ha condotto l'intero processo di industriale per gran parte dei progetti ricevendo numerosi riconoscimenti. Pertinenza nell'applicazione dei materiali, precisione progettuale e ricerca per l'innovazione, di forma e di funzione, caratterizzano da sempre l'approccio di Favaretto&Partners. Grazie alla competenza tecnica e alla passione per la sperimentazione, l'attività dello studio spazia in diversi ambiti dell'industrial design, dalla telefonia al furniture (sedute, illuminazione, imbottiti), dal medicale fino ai complementi per la casa. In particolare si è specializzato nella progettazione, prototipazione e industrializzazione di mobili per l'ufficio, sedute tecniche (operative, direzionali) e sistemi per collettività anticipando, in alcuni casi, linguaggi progettuali in seguito accolti e praticati anche da altri designer e produttori. Favaretto&Partners sostiene e pratica i principi del Design for All, dichiarazione accettata dalla Commissione Europea e promossa dall'IDD (Istituto Italiano Design Disabilità), a favore di una prassi progettuale che ha l'obiettivo di garantire l'accessibilità di luoghi e oggetti alla più ampia gamma di utenti.



**Marc Sadler**  
Austria

French citizen, born in Austria, Marc Sadler has lived and worked in France, North America, Asia and Italy. One of the first graduates in "esthétique industrielle" at the ENSAD in Paris with a thesis on plastics, he was a pioneer in experimentation on the different materials and contamination between technologies, which have become distinctive aspects of his work. At the beginning of the seventies, he's perfected the first ski-boot in thermoplastic material completely recyclable, subsequently commercialized by the Italian firm Caber. Today, thanks to his eclecticism, he's a consultant for a wide range of industry companies. Awarded 4 times with the Compasso d'Oro by ADI, the Industrial Design Association, (1994, 2001, 2008 e 2014) his work has won many international design awards over the years.

Francese, nato in Austria, Marc Sadler ha vissuto ed esercitato la professione di designer in Francia, Stati Uniti, Asia e Italia. Uno dei primi laureati in "esthétique industrielle" all'ENSAD di Parigi con una tesi sulle materie plastiche, è stato pioniere della sperimentazione dei materiali e della contaminazione fra le tecnologie, divenute aspetti distintivi della sua attività. All'inizio degli anni '70 mette a punto il primo scarpone da sci in materiale termoplastico interamente riciclabile, poi industrializzato dall'italiana Caber. Oggi grazie al suo eclettismo è consulente trasversale di aziende di ogni settore dell'industria. Vincitore 4 volte del Compasso d'Oro ADI, l'Associazione Design Industriale, (1994, 2001, 2008 e 2014) il suo lavoro è stato premiato molte volte a livello internazionale nel corso degli anni.

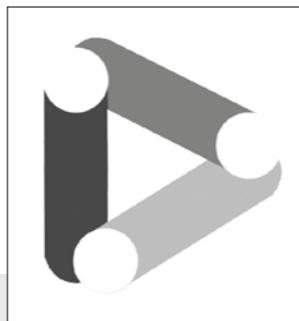

**EUROLINEA**  
Italia

The result of years of experience in the design of plastic, Eurolinea develops its activities by designing products ranging from furnishings such as chairs, tables, stools to get to the creation of household items and packaging, such as reusable containers, and other accessories. The large knowledge in engineering and industrial production of products and special Eurolinea pole makes cutting-edge technologies and solutions that are functional and innovative.

Frutto di anni di esperienza nella progettazione di manufatti plastici, Eurolinea sviluppa la sua attività ideando articoli che spaziano dai complementi d'arredo come sedie, tavoli, sgabelli per arrivare alla creazione di oggettistica per la casa e imballaggio, come contenitori multiuso, ed altri accessori. La grande conoscenza nel campo dell'ingegnerizzazione e industrializzazione di articoli e particolari fa di Eurolinea polo di tecnologie sempre all'avanguardia e soluzioni sempre funzionali ed innovative.



**GIAMPAOLO ALLOCCO**  
Italia

Delineo, derives from the latin word meaning "the one who designs". Delineodesign is the pseudonym I use for my projects. After my industrial high school diploma I worked in the sport system industry. I built up my self-confidence, I met extraordinary men, exceptional athletes and intelligent managers. I paid my dues and gained experience in product development, engineering, marketing and strategy consulting. I lived and absorbed all the ingenious and creative energy of the industrial system.

Delineo, deriva dal latino e significa "colui che disegna". Delineodesign è lo pseudonimo con cui firmo i miei progetti. Dopo il diploma industriale ho lavorato nello sport system. Ho conquistato fiducia, ho conosciuto uomini straordinari, atleti formidabili e manager intelligenti. Ho fatto gavetta e assimilato esperienza di product development, di engineering, di marketing e di strategy consulting. Ho vissuto e assorbito dal sistema industriale tutta l'energia propositiva e costruttiva possibile.



**SABRINA BETTINI**  
Brasile

She graduated in Architecture at the University 'St. Paul Mackenzie, and started working at some of the first architectural firms in Brazil and later in Italy, where she moved in 2003, gained significant experience in the field and at the same time he completed his doctorate at IUAV Venice. Sandonà encounter with Stefano Sandonà on a series of collaborations in the field of design to become an integral part of the study.

Si laurea in architettura all'università Mackenzie di San Paolo, ed inizia a lavorare presso alcuni studi di architettura prima in Brasile e successivamente in Italia, dove, trasferitasi dal 2003, matura significative esperienze sul campo e contemporaneamente ottiene la laurea presso lo IUAV di Venezia. Grazie all'incontro con Stefano Sandonà intraprende una serie di collaborazioni nel campo del design sino a diventare parte integrante dello studio.



**FORSIX**  
Italia

Six complementary souls for interdisciplinary approaches to creation. Experts in industrial and environmental design, synthesizers of aesthetic and emotional approaches, creators of furnishings and decoration sets and sceneries, image managers and masterplanning: Forsix combines the development of iconic, elegant and functional products, with marketing and Corporate art-direction. The creative approach of Forsix Industrial Design is to bypass the common obstacles in the products development through the use of innovative production technologies, the result of continuous research and prototyping, materials and processes knowledge.

Sei anime complementari per approcci interdisciplinari alla creazione. Esperti nel disegno industriale ed ambientale, sintetizzatori di approcci estetici ed emotivi, creatori di allestimenti e scenografie dell'arredamento e della decorazione, gestori dell'immagine e del masterplanning: Forsix coniuga lo sviluppo di prodotti iconici, eleganti e funzionali, alla comunicazione e all'Art Direction aziendale. L'approccio creativo di Forsix Industrial Design è quello di aggirare i comuni ostacoli nella realizzazione dei prodotti attraverso l'utilizzo di innovativi sistemi di produzione, frutto di una continua ricerca e prototipazione, della conoscenza dei materiali, della conoscenza dei processi.



**STEFANO SANDONÀ**  
Italia

Dialogue between different languages and cultures. Stefano Sandonà's creations are products of the elements of contemporary culture: graphism, the digital world, continuous motion. Inspiration drawn from travel, architecture and landscapes. Born in 1974, later undergoing an artistic education, since 1996 he has been working with professional design firms and several companies specialized in chairs, stools, tables and other types of system seating for the home, the office and the contract sector. He makes elaborate and dynamic products economically compatible with the client and the market, and works in collaboration with some companies which are able to take the project from the idea to production, with a high quality level. In 2006 he founded STEFANO SANDONÀ DESIGN. Its activities range from industrial design to product consulting and production, focusing especially on furniture. In just a few years he has received numerous awards and his works are present in museums and exhibitions.

Dialogo tra diversi linguaggi e culture. Le creazioni di Stefano Sandonà sono frutto della contaminazione degli elementi della cultura contemporanea: grafismo, mondo digitale, movimento. Ispirazioni tratte da viaggi, architetture e paesaggi. Nato nel 1974, dopo una formazione artistica, dal 1996 collabora con altri studi professionali e aziende nei settori casa, ufficio e contract, in particolare nella creazione e sviluppo di sistemi di sedute. Crea prodotti di forte processualità e dinamismo, economicamente compatibili con l'azienda e il mercato, e grazie alla collaborazione con altre aziende, può portare il progetto dall'idea fino alla produzione, ad alti livelli di qualità. Nel 2006 fonda lo studio STEFANO SANDONÀ DESIGN. Le sue attività spaziano dall'industrial design al product consulting, agli allestimenti, concentrandosi in modo particolare nel settore furniture. In pochi anni ha ricevuto prestigiosi riconoscimenti internazionali e i suoi lavori sono presenti in musei ed esposizioni.



**LAURA TOMBARI**  
Italia

Born in Pesaro in 1981, from 1995 to 2000 I attended the Art Institute of Urbino "Scuola del Libro", earning a diploma in "Graphic Design and Photography" with 100/100. In 2000 I enrolled in the Master of Science in Industrial Design at the Politecnico in Milan July 24, 2003 where I graduated in Industrial Design with 104/110. I worked in the sector of bars, ranging from local participating simultaneously planning the sessions for the community My work is my life, creating, designing I can express myself, I design objects are an expression of my creativity, my talent. Since May 2006, I embarked on the profession, creating one of my Industrial Design and Graphics office, receiving special mention in the competition Young & Design in 2008 with Flower chair.

Nata a Pesaro nel 1981, dal 1995 al 2000 ho frequentato l'Istituto d'arte di Urbino "Scuola del libro" conseguendo il diploma in "Grafica Pubblicitaria e Fotografia" con 100/100. Nell'anno 2000 mi sono iscritta al corso di Laurea in Disegno Industriale, presso il Politecnico di Milano dove il 24 Luglio 2003 ho conseguito la laurea in Disegno Industriale con 104/110. Ho lavorato nel settore dell'arredo bar, spaziando da realtà locali partecipando contemporaneamente alla progettazione e sedute per la collettività. Il mio lavoro è la mia vita, creando, ideando riesco ad esprimere la mia persona, gli oggetti che progetto sono espressione della mia creatività, del mio estro. Dal Maggio 2006, ho intrapreso la libera professione, creando un mio studio di Industrial Design e Grafica, ricevendo la menzione speciale al Concorso Young & Design 2008 con la seduta Flower.

**SEATING**  
**Collection**

# Nuta

Favaretto & Partners Design



Classic and authentic, elegant with fine detailing. Nuta is a seating collection made of technopolymer, with refined and timeless style, suitable for prestigious installations both indoors and out. These exquisitely defined lines of Nuta, harmoniously connected by Studio Favaretto, give a result that arouses wonder at first sight. Generous dimensions and superior ergonomic comfort distinguish Nuta in use, even for prolonged periods. A thin padded seat, as a welcome accessory, completes the possibility of combining the modern polymer colours with the most popular collections of fabrics and faux leathers.

Classica e autentica, elegante e di fine fattura. Nuta è una collezione di sedute realizzate in tecnopolimero, dallo stile raffinato e senza tempo, adatta ad installazioni di pregio sia indoor che out. I dettagli ricercati e le squisite linee di Nuta, armoniosamente connesse dallo Studio Favaretto, regalano un risultato che desta meraviglia fin dal primo impatto. Dimensioni generose e comfort ergonomico di livello superiore distinguono Nuta nell'utilizzo, anche per periodi prolungati. Una sottile seduta imbottita, quale gradito accessorio, completa la possibilità di poter abbinare i moderni colori dei polimeri con le più apprezzate collezioni di tessuti ed eco-pelli.



# Abuela

Favaretto & Partners Design



Abuela: an ambitious project, by Studio Favaretto & Partners, combines clean design with the uniqueness of detail, creating a very special combination dedicated to the most ambitious environments. The Abuela collection, developed in techno-polymer or solid beech wood, is suitable for the eye-catching hospitality and contract environments and is characterized by uncompromising comfort. The possibility of integrating chairs, armchairs and stools with an elegant and original design, always with bright and trendy colours, helps to create unique and precious indoor and outdoor environments.

Abuela: un progetto ambizioso, curato dallo Studio Favaretto & Partners, unisce la pulizia del design all'unicità dei dettagli, creando una combinazione particolarissima dedicata agli ambienti più ricercati. La collezione Abuela, sviluppata in tecnopolimero o in legno massello di faggio, si presta all'utilizzo nei più svariati ambienti dell'ospitalità e del contract ed è caratterizzata da un comfort senza compromessi. La possibilità di integrare sedie, sedie con braccioli e sgabelli dal design elegante ed originale, sempre con colori vivaci e trendy, aiuta a creare ambienti sia indoor che outdoor, unici e preziosi.



GOOD DESIGN AWARD 2018  
OF CHICAGO ATHENAEUM : MUSEUM OF ARCHITECTURE AND DESIGN





# Abuela Stool

Favaretto & Partners Design



The Abuela Stool reflects the uniqueness of the details and the clean design of the entire collection. Made of techno-polymer and available in two different sizes, the stool has a perfectly proportioned shape and suit both indoor and outdoor environments. Comfortable, light and simply stackable, Abuela Stool utilize the particular stacking system adopted by Gaber for its stools, ensuring product's aesthetic conditions are maintained for a long time, protecting it from wear. Suitable for a modern style as well as for more sophisticated environments, the stool is available in a wide trendy palette of colors, to be always the leading actor of your projects.

Lo sgabello Abuela rispecchia l'unicità dei dettagli e la pulizia del design dell'intera collezione omonima. Realizzato in tecnopolimero e disponibile in due dimensioni, il prodotto risulta essere perfettamente proporzionato, resistente sia per uso indoor che outdoor, confortevole anche per lunghe attese, leggero e semplicemente impilabile. Il particolare sistema di impilaggio adottato da Gaber per i propri sgabelli garantisce di conservare le condizioni estetiche del prodotto per lungo tempo, proteggendo il prodotto dall'usura. Adatto ad uno stile moderno come anche ad ambienti più sofisticati, lo sgabello è disponibile in un'ampia palette di colori per poter essere sempre protagonista dei vostri progetti.



# Abuela Wood

Favaretto & Partners Design

A complete range of functional and versatile chairs and barstools with softly elegant design. Unique solid beech details in a clean wraparound design create a winning combination for all your hospitality and commercial settings.

Abuela è una collezione completa di sedie e sgabelli, dalle linee morbide ed eleganti, funzionale e versatile. La struttura in legno massello di faggio, unitamente alla pulizia del design e all'unicità dei dettagli, creano una combinazione vincente per gli ambienti più ricercati.



# Fuller

Marc Sadler Design



Ongoing research into shapes and materials, combined with the most modern processing technologies, has given rise to the creation of the Fuller collection. Designed by Marc Sadler, the collection stands out by dint of its unusual frame design, a continuous game of empty and full spaces that intertwine to create an exciting three-dimensional effect. Fuller, a manifestation of Gaber's experience and ability to innovate, is a unique and surprising choice for dynamic workspaces and hospitality contract projects, where a stand-out look is required.

La continua ricerca nelle forme e nei materiali, unita alle più moderne tecnologie di trasformazione, hanno reso possibile la creazione della collezione Fuller. Disegnata da Marc Sadler, la collezione si distingue per l'improbabile design della scocca, un continuo gioco di spazi vuoti e pieni che intrecciandosi creano un emozionante effetto tridimensionale. Fuller, icona dell'esperienza e della capacità Gaber di innovare, è una scelta unica e sorprendente per aree di lavoro "agile" e dell'ospitalità più ricercata, dove sia necessario potersi distinguere.



# Fuller Stool

Marc Sadler Design



Ongoing research into shapes and materials, combined with the most modern processing technologies, has given rise to the creation of the Fuller collection. Designed by Marc Sadler, the collection stands out by dint of its unusual frame design, a continuous game of empty and full spaces that intertwine to create an exciting three-dimensional effect. Fuller, a manifestation of Gaber's experience and ability to innovate, is a unique and surprising choice for dynamic workspaces and hospitality contract projects, where a stand-out look is required.

La continua ricerca nelle forme e nei materiali, unita alle più moderne tecnologie di trasformazione, hanno reso possibile la creazione della collezione Fuller. Disegnata da Marc Sadler, la collezione si distingue per l'improbabile design della scocca, un continuo gioco di spazi vuoti e pieni che intrecciandosi creano un emozionante effetto tridimensionale. Fuller, icona dell'esperienza e della capacità Gaber di innovare, è una scelta unica e sorprendente per aree di lavoro "agile" e dell'ospitalità più ricercata, dove sia necessario potersi distinguere.



# Manaa

Studio Eurolinea Design



Manaa is just the armchair for your project! The shell's sinewy lines combine with a sturdy but understated techno-polymer frame as well as the variety of finishes to form a collection suitable for the many and varied demands of the hospitality and contract worlds. The techno-polymer frame, available in various striking colourways, proves to be hard-wearing even in heavy-duty environments. The Manaa collection is completed by the armchair version with splayed solid beech legs. This iconic version, with a choice of custom finishes, will elegantly complete your projects as a key ingredient. Manaa works well in offices and modern meeting rooms, too, with gaslift and swivel versions. The integrated tilt mechanism makes for suitable comfort even in demanding settings.

Manaa è la poltroncina ideale per il vostro progetto. Le linee sinuose della seduta, abbinata ad una robusta ma discreta struttura in tecnopolimero, unitamente alle varie finiture disponibili, rendono la collezione adattabile alle più svariate esigenze del mondo contract e dell'ospitalità. La struttura in tecnopolimero, disponibile in varie e vivaci colorazioni, risulta essere durevole anche per uso intensivo. La collezione Manaa è completata dalla poltroncina con gambe contrapposte in massello di faggio. Questa iconica versione, personalizzabile nelle finiture, completerà con eleganza e si renderà protagonista dei vostri progetti. Manaa si presta anche, nelle versioni girevoli e regolabili in altezza, all'uso nell'office e nelle moderne sale riunioni. La meccanica oscillante integrata permette di ottenere un confort adeguato all'utenza più esigente.



# Manaa Stool

Studio Eurolinea Design

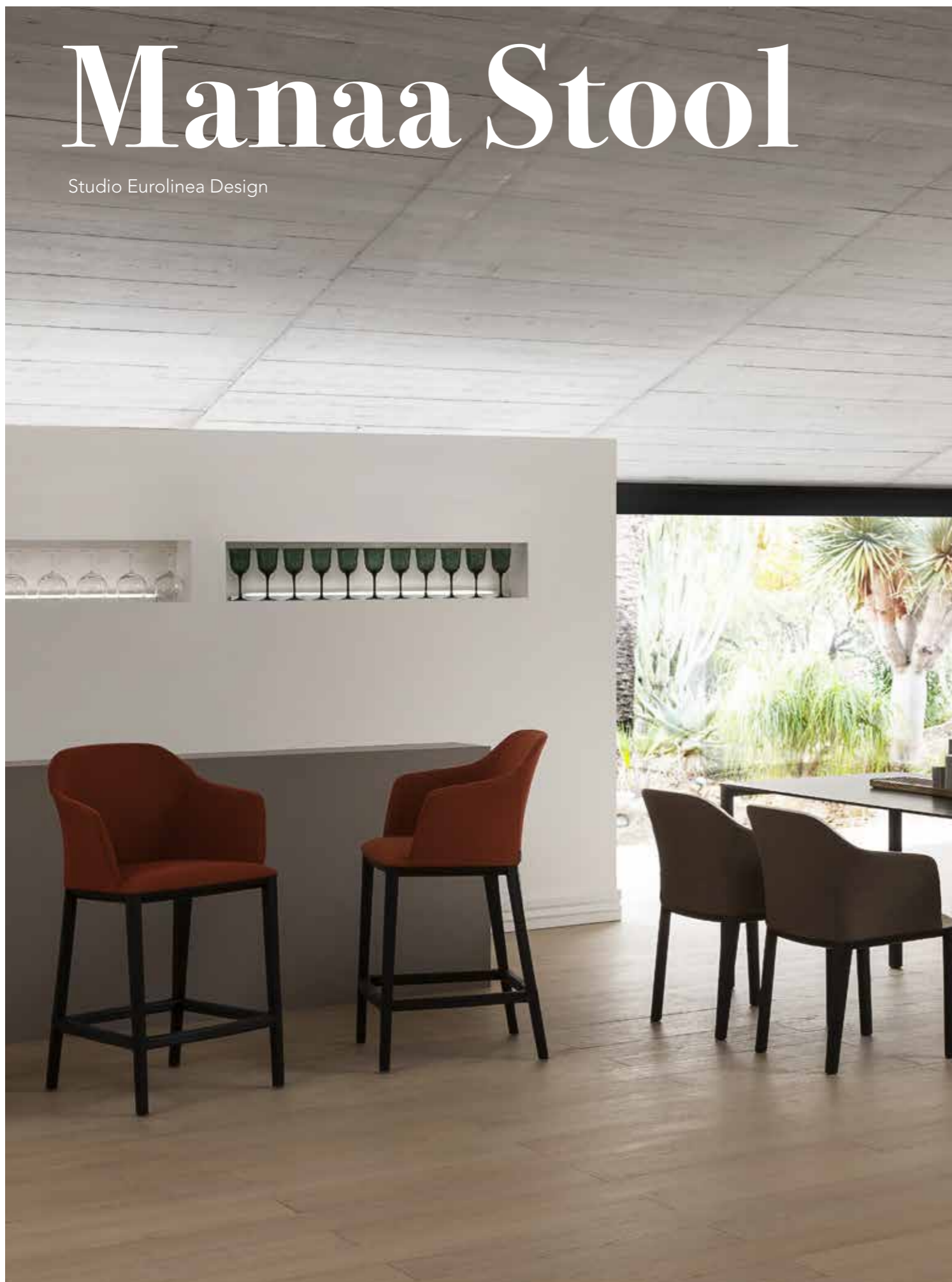

Manaa barstools come in various colours and with a choice of two seat heights, making them tick the boxes in settings created by the most meticulous of designers.

Gli sgabelli Manaa, disponibili in più colorazioni e in due diverse altezze della seduta, completano la possibilità di utilizzare la collezione Manaa negli ambienti creati dai designer più esigenti.

# M



# Manaa Slim

Studio Eurolinea Design



This collection designed by Studio Eurolinea, now enriched by the Manaa Slim version, lends itself to furnishing elegantly the most demanding contexts of work spaces and hospitality. Manaa Slim can be configured as a four-legged chair or stool version, with its practical, sturdy and coloured techno-polymer frame, or with its classic solid beechwood structure. The swivel versions then complete the offer to tastefully furnish the modern office and community environments, with the advantage of having endless finishes available.

La collezione disegnata dallo Studio Eurolinea, arricchita dalla poltroncina Manaa Slim, si presta ad arredare con eleganza e praticità i più esigenti contesti degli spazi di lavoro e dell'ospitalità.

Manaa Slim si può configurare quale seduta su quattro gambe o sgabello, con il pratico, robusto e colorato telaio in tecnopolimero, oppure con la classica struttura in legno massello di faggio.

Le versioni girevoli completano quindi l'offerta per arredare con gusto ambienti dell'ufficio moderno e della collettività, impreziosite dalle varie finiture disponibili.



# Manaa Slim Stool

Studio Eurolinea Design



This collection designed by Studio Eurolinea, now enriched by the Manaa Slim version, lends itself to furnishing elegantly the most demanding contexts of work spaces and hospitality. Manaa Slim can be configured as a four-legged chair or stool version, with its practical, sturdy and coloured techno-polymer frame, or with its classic solid beechwood structure. The swivel versions then complete the offer to tastefully furnish the modern office and community environments, with the advantage of having endless finishes available.

La collezione disegnata dallo Studio Eurolinea, arricchita dalla poltroncina Manaa Slim, si presta ad arredare con eleganza e praticità i più esigenti contesti degli spazi di lavoro e dell'ospitalità.

Manaa Slim si può configurare quale seduta su quattro gambe o sgabello, con il pratico, robusto e colorato telaio in tecnopolimero, oppure con la classica struttura in legno massello di faggio.

Le versioni girevoli completano quindi l'offerta per arredare con gusto ambienti dell'ufficio moderno e della collettività, impreziosite dalle varie finiture disponibili.





# Choppy

Favaretto & Partners Design

Choppy is a lively chair, designed specifically for contemporary lifestyles, with invitingly clean shapes that embrace you comfortably. Choppy combines the advantages of materials and fabrics designed for outdoor environments, with the refinement and comfort of the finest indoor seating. Made from a techno-polymer shell coated with a removable goose feather cushion, Choppy combines the glossy finish of durable materials with comfortable and colorful cushions, always making you welcome. Multiple support structures make it perfect and original for countless uses.

Choppy è una vivace poltroncina, progettata specificatamente per i lifestyle contemporanei, dalle forme aperte e pulite che avvolgono in un abbraccio confortevole. Choppy combina armoniosamente i vantaggi di materiali e tessuti studiati appositamente per ambienti outdoor, con la raffinatezza e il comfort delle più eleganti sedute per interni. Realizzata da una scocca in tecnopolimero rivestita con un cuscino in piuma d'oca sfoderabile, Choppy abbina la finitura lucida dei materiali inalterabili al look confortevole e colorato dei cuscini, per sentirsi sempre a proprio agio. Molteplici basamenti a sostegno della scocca la rendono perfetta ed originale per innumerevoli destinazioni d'uso.



# Choppy Sleek

Favaretto & Partners Design

Coming from Studio Favaretto inspiration, the Choppy Sleek Chair become a multi-purpose chair, made with soft contours and offering plenty of room to sit comfortably. The Choppy Sleek chair is ideal for quick waiting areas, large meeting rooms, and as a simple lounge option, thanks to its embracing shape for a break of full relax. A flexible product, with unconventional design, that can fit inside different kind of spaces, even hospitality environments.

Nata da un'ispirazione dello Studio Favaretto, Choppy Sleek diventa una sedia multiuso, realizzata con forme sinuose e spazi abbondanti. Choppy Sleek è ideale per aree di attesa, importanti sale riunioni o semplicemente in aree lounge, grazie alla sua forma avvolgente per un break rilassante. Un prodotto flessibile, dal design non convenzionale, facilmente adattabile a moderni ed ospitali ambienti contract.



# Clipperton

Marc Sadler Design



A contemporary profile, practicality, elegance and comfort are the key features of this seating family, which is also suited to outdoor use. The elegant and unusually textured shell can equally be upholstered to allow it to match even the most demanding taste.

Un profilo contemporaneo, praticità, eleganza e confort sono le caratteristiche principali di questa famiglia di sedute, adatte anche all'uso per esterni. La scocca, caratterizzata da una insolita ed elegante texture, è disponibile anche nella versione tappezzata, ideale per le più esigenti personalizzazioni.

INNOVATIONSPREIS  
ARCHITECTURE+  
OFFICE



GOOD  
DESIGN  
AWARD  
2017

OF CHICAGO  
ATHENAEUM :  
MUSEUM OF  
ARCHITECTURE  
AND DESIGN



# Clipperton Blend

Marc Sadler Design

A state-of-the-art feel with practicality, elegance and comfort – these are the hallmarks of Clipperton Blend, a range also suited to outdoor use. The unusually textured twin-colour shell creates a stand-out look and allows Clipperton Blend be personalized in numerous colour combinations, and adaptable to the most modern of settings.

Un profilo contemporaneo, praticità, eleganza e comfort sono le caratteristiche principali di questa famiglia di sedute, adatte anche all'uso per esterni. La scocca, caratterizzata da un' insolita ed elegante texture in rilievo, rende Clipperton Blend un oggetto adatto a distinguersi, personalizzabile alle più svariate esigenze ed adattabile alle scelte delle installazioni più moderne.



# Epica

Marc Sadler Design

Epica: the chair in the center. Centre of attraction and revolution, thanks to a particular integrated rotation system. A mix of timeless design between classic and the contemporary, skilfully engineered, first-class ergonomics and respect for the environment during the production and life of the product. Epica is made entirely of technopolymer. Epica-Eco version made entirely of wood pulp. The seat is available in the fixed version, 360° swivel or with swivel-and-return movement, helping the seat to ping back to its original position.

Epica: la sedia al centro. Centro di attrazione e rivoluzione, grazie ad un particolare sistema di rotazione integrato. Un mix di design senza tempo tra il classico e il contemporaneo, alta ingegnerizzazione, ergonomia di prima classe e rispetto dell'ambiente nella produzione e nella vita del prodotto. Epica è realizzata integralmente in tecnopolimero, oppure in "compound-wood" nella versione Epica-Eco. La seduta è disponibile nella versione fissa, girevole a 360°, oppure girevole con meccanica integrata "torno", che aiuta la seduta a ritornare alla posizione originale.



GOOD  
DESIGN  
AWARD  
2015

OF CHICAGO  
ATHENAEUM :  
MUSEUM OF  
ARCHITECTURE  
AND DESIGN

Interior  
Innovation  
award  
2015  
Winner



reddot design award  
winner 2015



# Dress Epica

Marc Sadler Design



The successful Epica collection now comes with a fully padded and upholstered shell, giving it a look that is a touch more stylish, cosy, comfy. Dress Epica is a mix of timeless design between the classic and the contemporary: skillfully engineered, first class ergonomics and respect for the environment throughout production and the life of the product. The shell is available fixed, with 360° swivel or with 90° swivel-and-return, helping it to ping back to its original position.

La collezione di successo Epica è arricchita di un guscio completamente imbottito e rivestito, donandole un aspetto ancor più elegante, accogliente, confortevole. Dress Epica è un mix di design senza tempo, tra il classico e il contemporaneo, alta ingegnerizzazione, ergonomia di prima classe e rispetto dell'ambiente nella produzione e nella vita del prodotto. La seduta è disponibile nella versione fissa, girevole a 360°, oppure girevole con meccanica integrata "torno", che aiuta la seduta a ritornare alla posizione originale.



# Bakhita

Studio Eurolinea Design



This is not an ordinary plastic chair. The 2K injection-process behind it makes it sturdy and durable. The technology is complex, the result is simple: a comfortable and high-quality lightweight stacking chair that fits in stylishly everywhere, from casual to formal, office to home, indoors and out. Bakhita makes it easy for people to pull up a chair and have a chat, lunch, or even a learning experience. Choose the chair with arms or without: both are available with a comfortable cushion.

Questa non è una sedia in plastica ordinaria. Il processo di iniezione plastica 2K con il quale viene realizzata la rende robusta e durevole. La tecnologia è complessa, il risultato è semplice: una seduta di alta qualità, leggera, impilabile, confortevole, che appare elegante e alla moda dovunque, dall'ambiente casual al formale, all'ufficio, alla casa, per interni e per esterni. E' semplice spostare Bakhita per una conversazione, un pranzo o un'esperienza di apprendimento e di formazione. Scegli la seduta con o senza braccioli: entrambe disponibili con un comodo cuscino.



# Bakhita Stool

Studio Eurolinea Design



A natural extension of the collection, with perfectly proportioned rigorous and dynamic shapes, the Bakhita barstool is perfectly suited to a young, modern lifestyle, as well as the formality of the most demanding environments. Available in two different heights, thanks to its lightness and to the simple stackability it is extremely multifunctional. The materials and the design make it sturdy and durable, and also suitable for outdoor use. The Bakhita barstool also comes with a padded and upholstered seat, and in a wide range of trendy vibrant colors.

Naturale completamento della famiglia, rigoroso e dinamico nelle forme, perfettamente proporzionato, lo sgabello Bakhita si adatta perfettamente ad uno stile giovane e moderno, come anche alla formalità degli ambienti più esigenti. Disponibile in due diverse altezze, grazie alla sua leggerezza e alla semplice impilabilità risulta essere estremamente polifunzionale. I materiali e i sistemi costruttivi lo rendono robusto ed inalterabile, adatto anche all'uso esterno. Disponibile anche con cuscino imbottito e tappezzato, Bakhita Stool è realizzato in una vasta serie di moderne e vivaci colorazioni.





# Isidora

Favaretto & Partners Design

The Isidora collection is easy to recognize and has a strong formal identity, the result of aesthetic and functional details that characterize its design. Isidora is both lightweight and stackable, thanks to the complex production system and the use of durable materials. It is sturdy and perfect for outdoor purposes. With easy stackability, the armrest version lends itself to hooked up onto a table edge to facilitate floor cleaning.

The Isidora range is completed with the option of upholstered seat and back, for extra comfort, and is enriched by a glossy rear back. Simple comfort, suitable for any environment, in any situation.

La famiglia Isidora ha una grossa riconoscibilità ed una forte identità formale, frutto dei dettagli stilistici estetici e funzionali che ne caratterizzano il design. Isidora, leggera ed impilabile, grazie al complesso sistema produttivo e all'utilizzo di materiali inalterabili, è robusta e resistente agli agenti atmosferici. Semplicemente impilabile, la versione con bracciolo si presta ad essere sollevata sul tavolo, per una semplice pulizia dei pavimenti.

La famiglia Isidora si completa con l'opzione di sedile e schienale tappezzati, e si arricchisce così di un retroschienale lucido. Semplicità e comfort: adatta a tutti gli ambienti, a tutte le situazioni.



# Isidoro

Favaretto & Partners Design

Designed by Studio Favaretto & Partners, the new Isidoro stool combine stackability and high-resistance, thanks to techno-polymer-metal co-injection.

Dello Studio Favaretto & Partners, the new Isidoro è il nuovo sgabello impilabile, dall'alta resistenza, realizzato per mezzo di co-iniezione tecnopolimero e metallo.

**YOUNG DESIGN**  
**GOOD DESIGN AWARD 2015**  
OF CHICAGO ATHENAEUM : MUSEUM OF ARCHITECTURE AND DESIGN



# Cucaracha

Favaretto & Partners Design

Designed by Studio Favaretto & Partners, the Cucaracha lounge armchair collection is defined by its soft and elegant lines. The lounge chair adapts perfectly to all environments requiring relax and comfort, or where waiting needs to be stress-free. The swivel seat, fitted with a tilt mechanism to increase comfort, is available in two different backrest heights. The armrest, finely integrated into the modern frame, turns out to be practical and elegant. The wide range of coverings and colours, all suited to contract settings, makes Cucaracha customizable to the trends of modern offices and hotels.

Disegnata dallo Studio Favaretto & Partners, la collezione di poltrone lounge Cucaracha è definita dalle linee morbide ed eleganti. Le sedute si adattano perfettamente a tutti gli ambienti dove è necessario unire il comfort al relax, o dove l'attesa non debba più essere un problema. La seduta girevole, provvista di una meccanica oscillante che ne amplifica il comfort, è disponibile in due diverse altezze dello schienale. Il bracciolo, finemente integrato nel moderno profilo della struttura, risulta essere pratico ed elegante. L'ampia gamma di rivestimenti e colori, sempre adatti al mondo del contract, rendono Cucaracha personalizzabile ai trend di uffici ed Hotels moderni.



# Cucaracha Slim

Favaretto & Partners Design



Cucaracha Slim is the natural extension from the Cucaracha Lounge Chair to meeting and semi-task seating. Ideal for hotel bedrooms, equally well as for modern office meeting rooms, this innovative Cucaracha collection stands out for its refined design, attention to detail, the soft and functional armrest, as well as the wide range of versions and finishes available.

Cucaracha Slim è la naturale estensione della famiglia Lounge alle poltroncine meeting e semi-operative. Ideale per la camera d'albergo, come per la sala riunioni di moderni uffici, questa innovativa collezione di poltroncine si distingue per il design ricercato, l'attenzione ai dettagli, il morbido e funzionale bracciolo, oltre alla molteplicità delle versioni e delle finiture utilizzabili.



# Elodie

Marc Sadler Design



Clean, well-defined lines, minimalist and functional. The Elodie seating family's versatility makes it ideal for executive and managerial workplaces, thanks to its three backrest heights and its discreetly integrated synchron mechanism. The 100% weight sensitive mechanism does not require any back tension adjustment, as it adapts automatically to the user's weight. Simple intuitive controls allow you to adjust the seat height, set the lumbar support and lock the backrest in three different positions. The key feature of the Elodie collection is its brand new sound-absorbent backrests. These backrests are made with an innovative "skeletal" double-shell structure, covered with coupled and thermoformed "felt-fabric" material. The room created by the structure and the two shells inside the backrest create a sound absorption case of frequencies, working in vocal range from 125Hz to 4000Hz: in this way, Elodie absorbs and reduces sound waves, considerably improving the workplace, even in open-plan set-ups.

Linee semplici e decise, forme essenziali e funzionalità. La famiglia di sedute Elodie è versatile ed adatta all'utilizzo in ambienti operativi e direzionali, grazie alle tre altezze dello schienale e al meccanismo sincronizzato integrato. Il movimento auto-pesante non necessita di regolazione della tensione dello schienale, in quanto si adatta al peso dell'utilizzatore. La possibilità di bloccare lo schienale in tre posizioni, la regolazione lombare e la regolazione dell'altezza della seduta avvengono per mezzo di semplici comandi intuitivi.

Caratteristica principale della nuova collezione Elodie è l'utilizzo di un inedito schienale fonoassorbente. Gli schienali sono realizzati con un'innovativa struttura "scheletrica" a doppio-guscio, rivestita con materiale accoppiato e termoformato "feltro-tessuto". La particolare struttura dello schienale e i gusci che la raccolgono, creano una cassa di assorbimento delle frequenze, funzionante in gamma vocale dai 125Hz ai 4000Hz: in questo modo Elodie trattiene e riduce le onde sonore, migliorando considerevolmente il benessere nell'ambiente di lavoro, anche in contesti open-space.

UNI EN ISO 354:2003  
SOUND ABSORPTION TESTED



# Teckel

Studio Eurolinea Design

Considerable research at stylistic and ergonomic levels sums up this stylishly comfortable chair. The handle in the backrest makes for easy manoeuvrability.

L'approfondita ricerca stilistica ed ergonomica sintetizza in pochi tratti essenziali una seduta sofisticata e assolutamente confortevole. La maniglia integrata nel disegno della scocca è ottimale per una semplice trasportabilità.



# Akami

Stefano Sandonà Design



Akami chairs are some of the most reliable, comfortable and stackable chairs in the Gaber collection. The ergonomic and stylish research encapsulates in a few essential features a sophistication and comfort. Thanks to the special 1034 elliptical holes in the back of the Akami chair, the chair itself is able to breathe while the user experiences a sense of general well-being, even during prolonged use. The handle integrated into the design of the shell makes for easy moving around. Link them together to create rows of seating or arrange them to fit any corporate office, conference room or public space. Seats come in your choice of techno-polymer or upholstery, with a wide variety of colors and finishes.

Le sedute Akami sono alcune delle più affidabili, confortevoli ed impilabili sedute della collezione Gaber. L'approfondita ricerca stilistica ed ergonomica, sintetizza in pochi tratti essenziali una seduta sofisticata e assolutamente confortevole. La particolare foratura dello schienale, realizzata con 1034 fori ellittici, consente una corretta traspirazione e un benessere generale dell'utente, anche per un uso prolungato. La maniglia integrata nel disegno della scocca è ottimale per una semplice trasportabilità. Unisci tra loro le sedie e disponile su file, oppure utilizzale per la realizzazione di uffici, sale conferenza e spazi pubblici: la collezione è disponibile a scelta tra il tecnopolimero o le versioni tappezzate, con una larga gamma di colori e finiture che permettono un'ampia customizzazione.

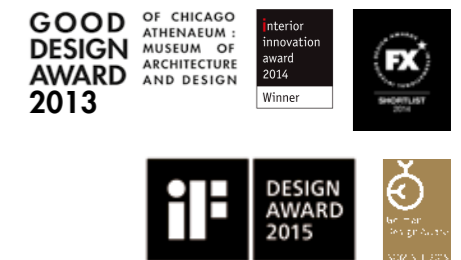

# Akami Stool

Stefano Sandonà Design



The ergonomic and stylish research on Akami chairs and stools encapsulates in a few essential features a sophistication and comfort. Thanks to its special 1034 elliptical holes in the back of the Akami collection, the chair itself is able to breathe while the user experiences a sense of general well-being, even during prolonged use. The handle integrated into the design of the shell makes for easy moving around.

L'approfondita ricerca stilistica ed ergonomica sintetizza in pochi tratti essenziali una collezione di sedute e sgabelli sofisticata e assolutamente confortevole. La particolare foratura dello schienale, realizzata con 1034 fori ellittici, consente una corretta traspirazione e un benessere generale dell'utente, anche per un uso prolungato. La maniglia integrata nel disegno della scocca è ottimale per una semplice trasportabilità.

GOOD DESIGN AWARD 2013  
OF CHICAGO ATHENAEUM : MUSEUM OF ARCHITECTURE AND DESIGN  
Interior Innovation award 2014 Winner





# Slot Fill

Favaretto & Partners Design

Stackable, versatile, easy to handle, elegant and refined, Slot is suitable for many and varied uses: from community areas to the modern office, from breakout to residential. The comfortably proportioned Slot and Slot Fill use a blend of techno-polymer material, suitable for outdoors, in eight vibrant colours. In this way, the Slot collection develops in two variants and three size options, in addition to a series of stools available in countless finishes.

Impilabile, versatile, maneggevole, elegante e raffinata, Slot è adatta a molteplici usi: dalla collettività all'ufficio moderno, dal break-out al residential. Slot e Slot Fill, caratterizzate da confortevoli dimensioni, utilizzano un blend di tecnopolimero, utilizzabile anche all'esterno, in otto diverse vivaci colorazioni. La collezione Slot si sviluppa in due varianti e tre dimensioni, oltre ad una serie di sgabelli, dalle innumerevoli finiture.



# Slot

Favaretto & Partners Design

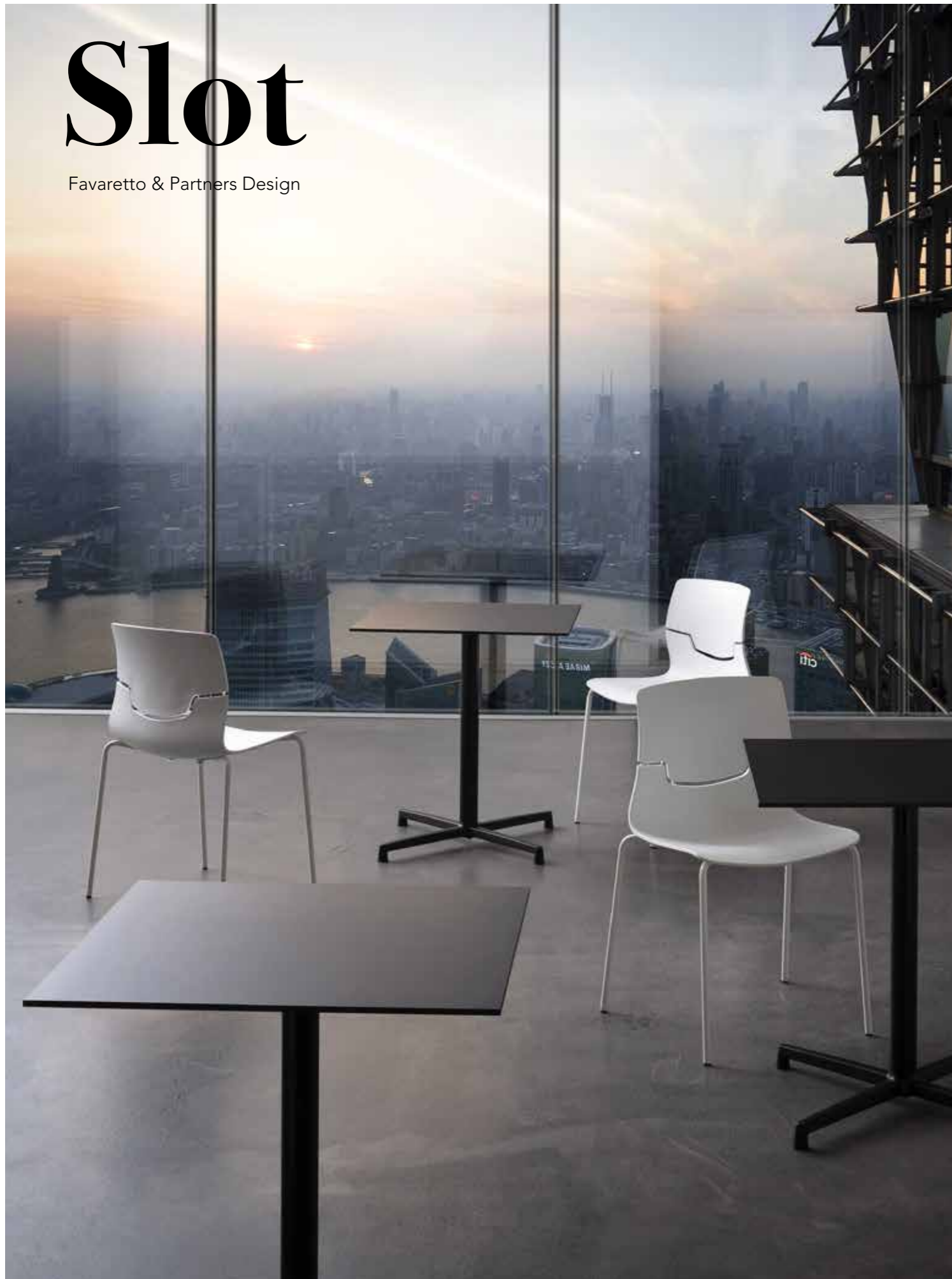

Stackable, versatile, easy to handle, elegant and refined, Slot is suitable for many and varied uses: from community areas to the modern office, from breakout to residential.

The comfortably proportioned Slot and Slot Fill use a blend of techno-polymer material, suitable for outdoors, available in vibrant colours and countless finishes.

Impilabile, versatile, maneggevole, elegante e raffinata, Slot è adatta a molteplici usi: dalla collettività all'ufficio moderno, dal break-out al residential. Slot e Slot Fill, caratterizzate da confortevoli dimensioni, utilizzano un blend di tecnopolimero, utilizzabile anche all'esterno, disponibile in vivaci colorazioni e innumerevoli finiture.

GOOD DESIGN AWARD 2013

OF CHICAGO ATHENAEUM : MUSEUM OF ARCHITECTURE AND DESIGN



# Slot

Favaretto & Partners Design



Slot is suitable for different settings, from conference to break-out, from formal corporate offices to more relaxed lounges. The padded and upholstered version, is enhanced with feature stitchwork, whilst maintaining the essential design aspects of the Slot family. Gaber offers endless textures and fabrics, also with twin-color upholstery details on request.

Slot è adatta a vari ambienti, dalla sala conferenza al break-out, dall'ufficio all'area relax. La versione imbottita e tappezzata, rifinita da cuciture sartoriali, impreziosisce l'oggetto, riprendendo sempre il disegno estetico caratterizzante la famiglia. Gaber offre infinite varianti di trame e tessuti, anche con dettagli di tappezzeria bicolore disponibili su richiesta.

# S



# Slot Lounge

Favaretto & Partners Design

Slot is suitable for different settings, from conference to break-out, from formal corporate offices to more relaxed lounges. The padded and upholstered version, is enhanced with feature stitchwork, whilst maintaining the essential design aspects of the Slot family. Gaber offers endless textures and fabrics, also with twin-color upholstery details on request.

Slot è adatta a vari ambienti, dalla sala conferenza al break-out, dall'ufficio all'area relax. La versione imbottita e tappezzata, rifinita da cuciture sartoriali, impreziosisce l'oggetto, riprendendo sempre il disegno estetico caratterizzante la famiglia. Gaber offre infinite varianti di trame e tessuti, anche con dettagli di tappezzeria bi-colore disponibili su richiesta.



# Slot Fill Stool

Favaretto & Partners Design



The Slot and Slot Fill stools are part of the Slot and Slot Fill chair collection, sharing simple and multi-functional design that makes it ideal for contract or community environments. The padded and upholstered version, is enhanced with feature stitchwork, whilst maintaining the essential design aspects of the Slot family.

Gli sgabelli Slot e Slot Fill fanno parte della collezione di sedute omonime, adatti quindi ad essere integrati nella stessa famiglia di prodotti o, grazie al design semplice e ogni tempo, essere utilizzati sia in ambienti contract che collettività. La versione imbottita e tappezzata, rifinita da cuciture sartoriali, impreziosisce l'oggetto, riprendendo sempre il disegno estetico caratterizzante la famiglia.



# Slot Stool

Favaretto & Partners Design



The Slot and Slot Fill stools are part of the Slot and Slot Fill chair collection, sharing simple and multi-functional design that makes it ideal for contract or community environments. The padded and upholstered version, is enhanced with feature stitchwork, whilst maintaining the essential design aspects of the Slot family.

Gli sgabelli Slot e Slot Fill fanno parte della collezione di sedute omonime, adatti quindi ad essere integrati nella stessa famiglia di prodotti o, grazie al design semplice e ognitempo, essere utilizzati sia in ambienti contract che collettività. La versione imbottita e tappezzata, rifinita da cuciture sartoriali, impreziosisce l'oggetto, riprendendo sempre il disegno estetico caratterizzante la famiglia.

GOOD DESIGN AWARD 2013

OF CHICAGO ATHENAEUM : MUSEUM OF ARCHITECTURE AND DESIGN



# Jubel

Forsix Design



Our long-standing passion for innovation leads us to create Jubel: a solid and stylish choice for Meeting and Conference Areas, Training and Lecture rooms, Canteen and Waiting Areas, or for Office Visitor seating, swivel, or in various stackable and linkable versions. The unique shape of the back and the clean design lines make Jubel stand out for its comfort, allowing it to be the star of hospitality or office installations. Jubel is available in our attractive range of shell colours and can be upgraded with a padded seat upholstery, or with the shell fully stitched and upholstered.

Grazie alla nostra storia e alla passione per l'innovazione, unita alla capacità della produzione industriale, abbiamo creato Jubel: scelta perfetta per le vostre aree meeting e conferenza, sale training e di lettura, mense e aree attesa, per arrivare infine alle più ricercate versioni girevoli, agganciabili per disporle in linea ed impilabili. Jubel è un prodotto estremamente confortevole, grazie alla forma unica dello schienale e alle gentili curve che accompagnano il design minimale e mai invasivo delle sue innumerevoli versioni. Jubel è disponibile in un'attraente palette di colori ed è possibile incrementare le finiture con la tappezzeria della seduta o con l'intera scocca imbottita e tappezzata.



# Jubel Stool

Forsix Design



Our long-standing passion for innovation leads us to create Jubel: a solid and stylish choice for Meeting and Conference Areas, Training and Lecture rooms, Canteen and Waiting Areas, or for Office Visitor seating, swivel, or in various stackable and linkable versions.

The unique shape of the back and the clean design lines make Jubel stand out for its comfort, allowing it to be the star of hospitality or office installations. Jubel is available in our attractive range of shell colours and can be upgraded with a padded seat upholstery, or with the shell fully stitched and upholstered.

Grazie alla nostra storia e alla passione per l'innovazione, unita alla capacità della produzione industriale, abbiamo creato Jubel: scelta perfetta per le vostre aree meeting e conferenza, sale training e di lettura, mense e aree attesa, per arrivare infine alle più ricercate versioni girevoli, agganciabili per disporle in linea ed impilabili. Jubel è un prodotto estremamente confortevole, grazie alla forma unica dello schienale e alle gentili curve che accompagnano il design minimale e mai invasivo delle sue innumerevoli versioni. Jubel è disponibile in un' attrattiva palette di colori ed è possibile incrementare le finiture con la tappezzeria della seduta o con l'intera scocca imbottita e tappezzata.





# Kanvas

Stefano Sardonà Design

Kanvas is a contemporary, lightweight collection of stacking chairs and stools. Its sleek, lean design and its glossy finishing are inspired by the beauty of neoclassical sculptures. Designed with a beautiful sculpted back, Kanvas has a gently controlled flex that moves with the user's bodyweight to provide comfort, even for extended periods. Kanvas compact dimensions make it ideal for high-density applications such as training and conference, auditoriums, educational and healthcare. Its fresh, modern profile is also attractive in a retail setting, cafeterias and recreational spaces. Front and full upholstery, with countless combinations and minimal thickness, complete the collection.

Kanvas è una collezione contemporanea di sedute e sgabelli, leggeri ed impilabili. Il suo design elegante e snello, le sue finiture lucide, sono ispirate dalla bellezza delle sculture neoclassiche. Disegnata con uno straordinario schienale, Kanvas offre un dolce e controllato movimento di flessione, che si adatta al corpo dell'utente, rivelando un piacevole confort anche per lunghi periodi. Le dimensioni contenute di Kanvas la rendono ideale in aree di formazione e sale conferenza, auditorium, aule e strutture sanitarie. Il suo fresco profilo moderno è anche attraente in un ambiente di vendita, caffetterie e spazi ricreativi. Completano il prodotto la tappezzeria frontale, dagli innumerevoli abbinamenti e dagli spessori minimali, e la versione tappezzata integralmente.



# Kanvas Stool

Stefano Sandonà Design

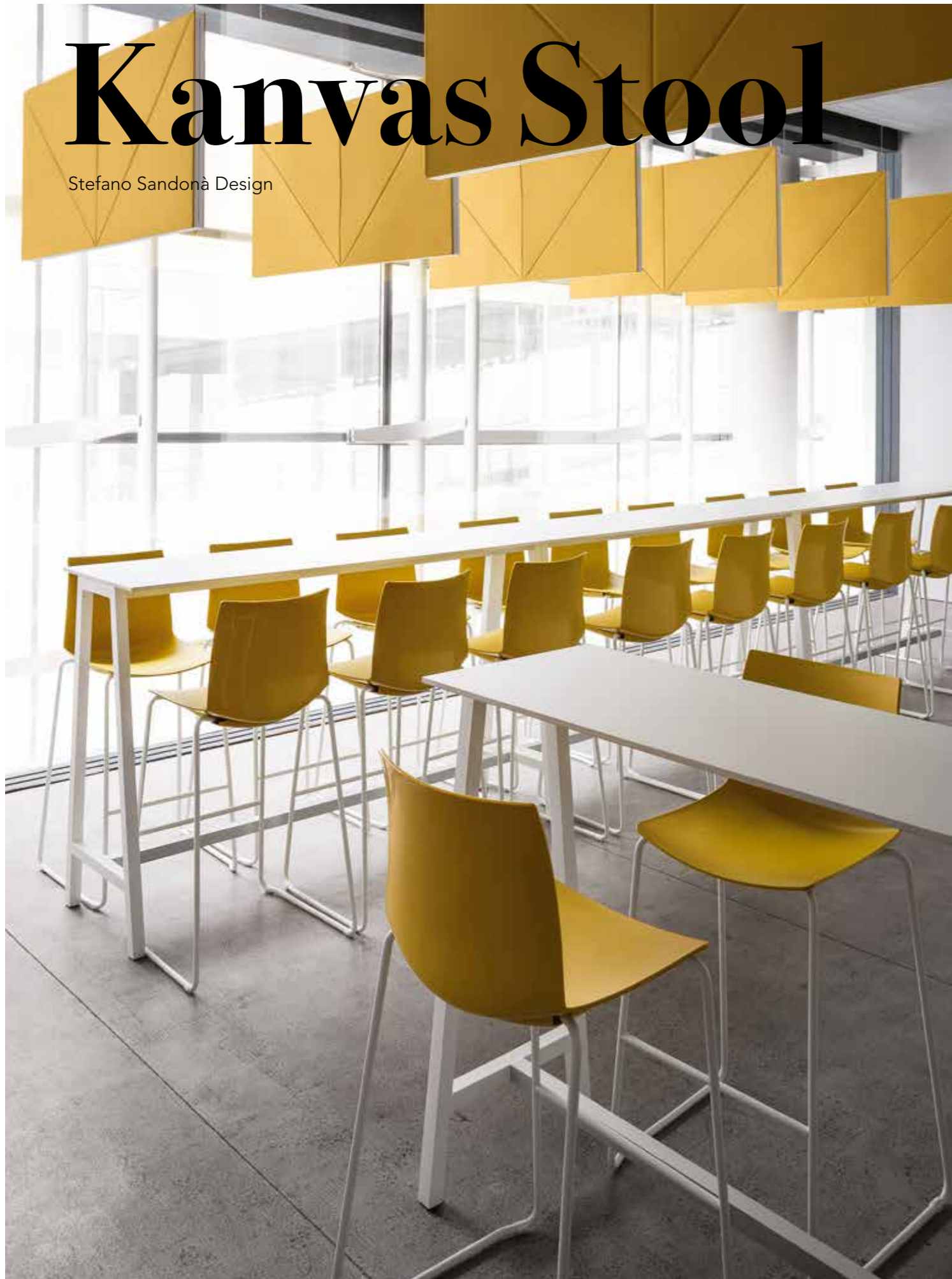

Kanvas is a contemporary, lightweight collection of stacking chairs and stools. Its sleek, lean design and its glossy finishing are inspired by the beauty of neoclassical sculptures. Designed with a beautiful sculpted back, Kanvas Stool has a gently controlled flex that moves with the user's bodyweight to provide comfort, even for extended periods. Its fresh, modern profile is also attractive in a retail setting, cafeterias and recreational spaces. Front and full upholstery, with countless combinations and minimal thickness, complete the collection.

Kanvas è una collezione contemporanea di sedute e sgabelli, leggeri ed impilabili. Il suo design elegante e snello, le sue finiture lucide, sono ispirate dalla bellezza delle sculture neoclassiche. Disegnato con uno straordinario schienale, Kanvas Stool offre un dolce e controllato movimento di flessione, che si adatta al corpo dell'utente, rivelando un piacevole confort anche per lunghi periodi. Il suo fresco profilo moderno è anche attraente in un ambiente di vendita, caffetterie e spazi ricreativi. La tappezzeria frontale, dagli innumerevoli abbinamenti e dagli spessori minimali, e la versione tappezzata integralmente, completano il prodotto.



# Kanvas 2

Stefano Sandonà Design

Designed by Stefano Sandonà, Kanvas 2 is the natural extension of the contemporary collection of chairs and stools: an extended seating system easy to customize. Thanks to its unique design it adapts to flexible and multi-functional spaces, hosting many of your day to day activities. Steel, wood, techno polimer, aluminum and coverings, combined together by designers imagination will create unique and stunning environments.

Disegnata da Stefano Sandonà, Kanvas 2 è il naturale completamento della collezione contemporanea di sedute e sgabelli: un sistema ampio e adatto ad essere personalizzato. Grazie al suo design unico, si adegua agli spazi flessibili e multifunzionali che consentono di ospitare varie attività durante l'arco della giornata. Acciaio, legno, tecnopolimero, alluminio e rivestimenti, combinati insieme dalla fantasia dei progettisti danno vita ad ambienti unici.



# Kanvas Lounge

Stefano Sandonà Design



Kanvas lounge is the natural complement to the Kanvas family. This is perfect for professional places, such as hotel lobbies, waiting and breakout areas. It is a comfortable chair available in various fabrics with a chromed or white painted swivel steel frame or metal sled version.

Kanvas lounge è il naturale complemento alla famiglia Kanvas. E' ideale per arredare in modo sobrio e professionale gli spazi come hall di albergo, aree breakout e di attesa. E' una seduta confortevole proposta in diversi tessuti e con un telaio a base centrale cromata e verniciata bianca, o con telaio slitta in metallo.



# More

Studio Eurolinea Design

More and More...An extensive seating collection, for indoor or outdoor environments, versatile and stylish. But, above all, a unique collection. The result is More, a single techno-polymer shell that can equally well be fully upholstered, or simply enriched with a cushion specially created. The cushion adopts a clever solution: it is fixed to the body-shell by 9 buttons, making it easy to apply or remove when necessary.

Più e ancora di Più...Una seduta importante, per ambienti indoor o outdoor, versatile, elegante. Ma soprattutto assolutamente unica. Nasce così More, una monoscocca in tecnopolimero che si presta ad essere rivestita integralmente, o semplicemente arricchita con un cuscino creato ad hoc. Il cuscino adotta una soluzione intelligente: si fissa alla scocca mediante 9 bottoni, rendendo molto semplice l'operazione di applicazione e rimozione alla necessità.



# Prodige

Giampaolo Allocco Design

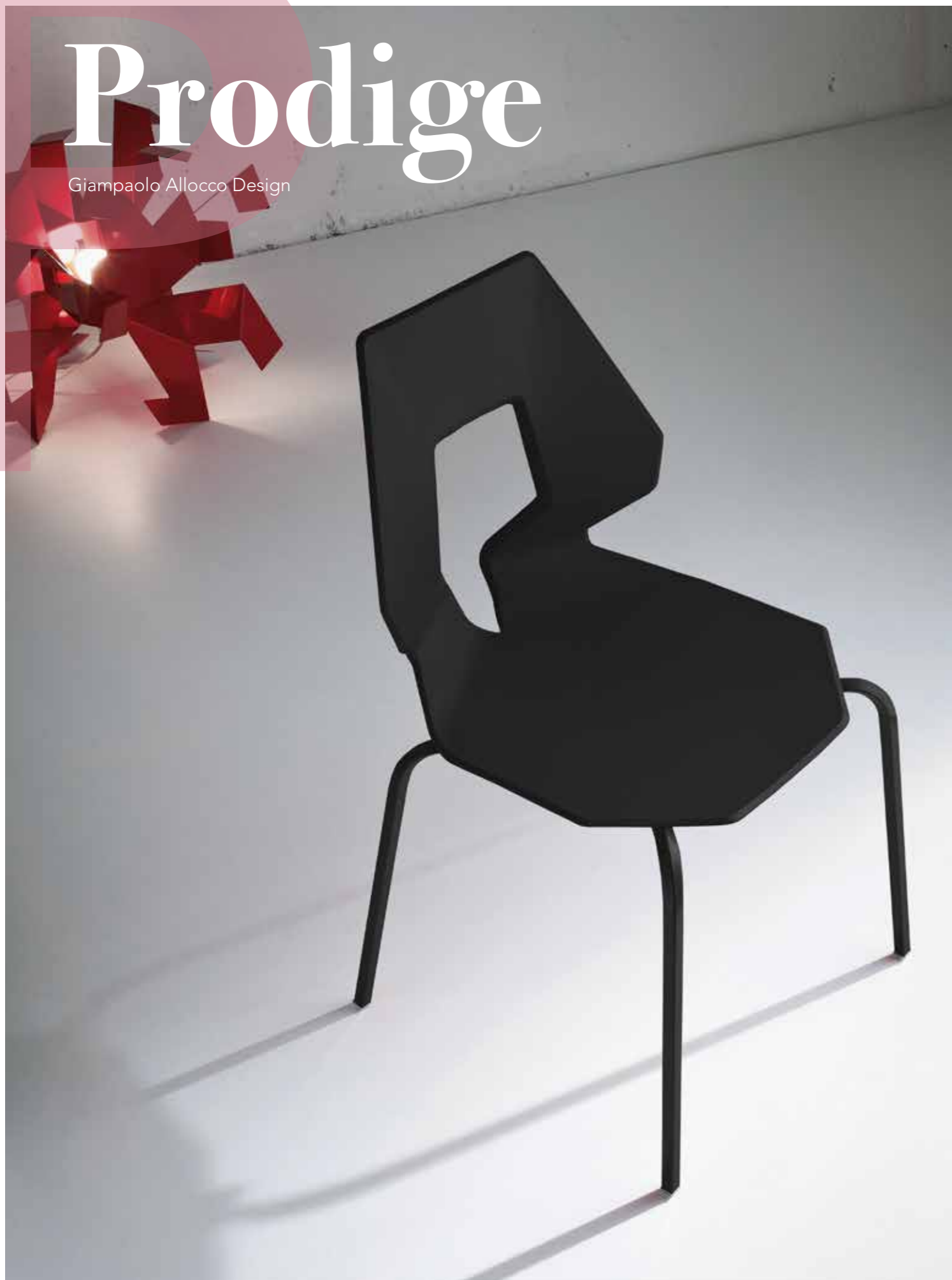

Special characteristics of materials and attention to design perfectly blend in this chair through clean lines and rigorous contemporary shapes. Prodige is a comfortable chair, balanced in design and sizes, suitable as well in training areas and conference rooms, auditoriums, classrooms and community environments. And, of course, outdoors.

Particolari caratteristiche materiche e cura del disegno si fondono perfettamente in questa seduta dalle linee pulite e dal carattere rigoroso e contemporaneo. Prodige è una seduta confortevole, equilibrata nel disegno e nelle dimensioni, adatta anche in aree di formazione e sale conferenza, auditorium, aule e ambienti collettività in genere. Oltre ovviamente, all'outdoor.



# Prodige Stool

Giampaolo Allocco-Design



Available in two different heights, suitable for residential use as well as for the most demanding hospitality projects, the Prodige stool has a wide range of playful colors, both for its techno-polymer shells and its metal frames.

Disponibile in due altezze, adatto sia all'uso residenziale che per i più esigenti progetti contract, lo sgabello Prodige si distingue per la vasta gamma di vivaci colori, sia della scocca che delle strutture.

P



# Basket Chair

Alessandro Busana Design

Basket is one of Gaber's most versatile furniture series. An armchair characterized by an elegant graphic composition based on alternations of full and empty spaces, conferring a strong personality, making it rich and at the same time delicate. The Basket Chair is inspired by the traditional wicker containers, a comfortable "container to sit in". Capable of characterizing its surrounding environment. The Basket Chair is suitable for indoor and outdoor use; from conference to breakout; from formal offices to more relaxed lounges. Also available is a special upholstered and nonslip removable cushion, creating an original contrast between plastic and fabric materials.

Basket Chair è una delle collezioni Gaber più versatili. E' una poltroncina caratterizzata da un'elegante composizione grafica basata su un'alternanza tra pieni e vuoti che attribuisce forte personalità, rendendola ricca ed eterea nel contempo. Basket Chair si ispira ai tradizionali contenitori in rattan, un confortevole "contenitore su cui sedersi". Un contenitore capace di caratterizzare fortemente l'ambiente che lo circonda. Basket Chair è utilizzabile sia in ambienti indoor che outdoor, dalla sala conferenza al break-out, dall'ufficio all'area relax. E' disponibile inoltre una cover imbottita antiscivolo removibile, che veste perfettamente la seduta creando un originale contrasto tra materiale plastico e tessuto.





# Dress Basket Chair

Alessandro Busana Design



The Dress Basket Chair is a multi-purpose chair, made with soft contours and offering plenty of room to sit comfortably. This chair is the result of close collaboration between the designer and Gaber, with the shared ambition to create a chair collection where all the shells can be combined with a variety of base types. Simple comfort, suitable for any environment, in any situation.

Dress Basket Chair è una poltroncina multiuso, dalle forme sinuose e dagli spazi abbondanti. La poltroncina è frutto di una stretta collaborazione tra il designer e Gaber, l'ambizione di entrambi mirava nel creare una collezione di sedute dove tutte le scocche potessero essere combinate con diverse tipologie di basamenti. Semplicità e comfort: adatta a tutti gli ambienti, a tutte le situazioni. Un design unico per coprire le più svariate esigenze del contract moderno.



# Chevalet

Favaretto & Partners Design



Chevalet...is an armchair that may appear rigid but which instead turns out to be extremely comfortable when you sit on it.. The back, inclining slightly forwards, characterizes the design, but, as soon as you sit on it, it proves to be most comfortable. Even the soft and slightly opening armrests invite you to sit down, and then envelope you in comfortable relaxation. The finishes, quality tailoring, and the completely removable covering, make Chevalet an attractive piece, suitable for various environments, such as home, contract and office.

Chevalet...è una poltroncina che, apparentemente rigida, si rivela invece estremamente confortevole una volta seduti. Lo schienale, inusualmente inclinato in avanti, ne caratterizza innanzi tutto l'immagine, ma si scopre come diventi avvolgente e comodo quando ci si siede. Anche il bracciolo, leggermente aperto verso l'esterno e piacevolmente morbido, invita a sedersi, avvolgendo poi l'utilizzatore in un comodo relax. Le finiture di qualità sartoriale e il rivestimento completamente sfoderabile, ne sottolineano la contemporaneità, facendone un oggetto accattivante ed inseribile nei più svariati contesti...casa, contract, ufficio.

**GOOD DESIGN AWARD 2014**  
OF CHICAGO ATHENAUM : MUSEUM OF ARCHITECTURE AND DESIGN

interior innovation award 2014  
Winner

Good Design Award  
SPECIAL MENTION 2013



# Finferlo

Favaretto & Partners Design



Finferlo is distinguished by playful and fun design, the ottoman with two large lapels, like the neck of a jacket, indicate the starting point of the two hinges that, sliding down around the perimeter of the object, allow you to remove the cover or to open it just enough to create room for magazines or accessories. A small loop with the product name embroidered makes this lightweight piece easy to move around. The sartorial details make Finferlo an attractive addition, providing casual seating for lounge environments or workstation applications.

Finferlo.. design vivace e divertente per un pouf con due ampi revers, simili al collo di una giacca, indicano il punto di partenza delle due cerniere che scorrendo lungo tutto il perimetro dell'oggetto permettono di staccare il rivestimento perimetrale esterno o di aprirlo quanto basta per creare uno spazio di contenimento per riviste e/o oggetti vari.

Una piccola asola con il nome del prodotto ricamato, permette di trasportarlo con estrema facilità grazie alla sua leggerezza. I dettagli sartoriali ne fanno un oggetto accattivante, adatto anche ad ambienti ufficio o lounge-area.



# Moema

Stefano Sandonà Design



Moema is cozy. Cozy thanks to a simple wrap-around design. The techno-polymer shell, suitable for indoors or out, or the leather upholstered version; wooden, plastic or steel frames make Moema suitable for a multitude of purposes. And Moema is always contemporary, renewable, accessible, stackable, colorful and full of bright finishes.

Moema è accogliente. Accogliente grazie ad un design semplice, avvolgente, adatto. Adatta all'ambiente interno o esterno, la scocca in tecnopolimero, o imbottita e rivestita in pelle, la rendono multiuso. Multiuso perché sempre attuale, sempre rinnovabile, accessibile, ampia, impilabile, ricca di colori e vivace nelle finiture.

GOOD DESIGN AWARD 2009

OF CHICAGO ATHENAEUM : MUSEUM OF ARCHITECTURE AND DESIGN



reddot design award winner 2010

interior innovation award 2012 Winner

Designers International 2012 NOMINEE

Interior Design Award 2012 NOMINEE



# Moema Stool

Stefano Sandonà Design



Suspended design and glossy surfaces characterize this slinky stool, available on a height-adjustable chrome base.

For greater comfort and a more sophisticated look, the Moema stool seat is available upholstered in leather with feature stitchwork.

La linea sospesa e le superfici lucide caratterizzano questo armonioso sgabello, disponibile su basamento cromato, regolabile in altezza. Per un maggiore confort e per un'estetica più ricercata, è disponibile la versione con seduta imbottita e tappezzata in pelle, con cuciture a vista.

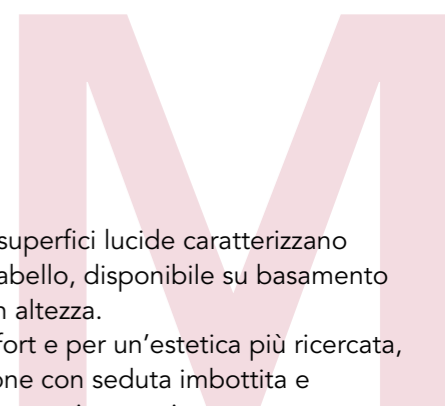

GOOD DESIGN AWARD 2009  
OF CHICAGO ATHENAEUM : MUSEUM OF ARCHITECTURE AND DESIGN



# Colorfive

Stefano Sandonà Design

Bright colors and pastel shades combine as multicolored decorations that look like paintings. Gradations of grey, green, brown express the true colors of nature. The revolutionary Colorfive collection of Stefano Sandonà uses the most advanced technology of plastic injection and a palette of original colors. With prêt à porter style, and the various colors available, Colorfive matches perfectly any indoor and outdoor environment. Infinite design possibilities.

Colori brillanti e pastello, tinte ton-sur-ton, decori che sembrano dipinti. Gradazioni cromatiche del grigio, del verde, del marrone, che esprimono i colori più veri della natura. La rivoluzionaria collezione Colorfive di Stefano Sandonà utilizza la più avanzata tecnologia di iniezione plastica e una palette di colori brillanti. Con il suo stile prêt à porter, e le varie colorazioni a disposizione, si abbina perfettamente a qualsiasi ambiente indoor e outdoor. Infinite possibilità di design.



**GOOD  
DESIGN  
AWARD  
2011**

OF CHICAGO  
ATHENAEUM :  
MUSEUM OF  
ARCHITECTURE  
AND DESIGN



reddot design award  
honourable mention 2011



# Colorfive Wrap

Stefano Sandonà Design



A natural evolution of the Colorfive family, proposed with a soft and pleasant fabric, conveying a sense of classic elegance and quality craftsmanship.

Evoluzione istintiva della famiglia Colorfive, proposta con un tessuto morbido e piacevole. Una finitura sartoriale per un prodotto ognitempo, che richiama un'eleganza classica ed un artigianato di alta qualità.



# Colorfive Stool

Stefano Sandonà Design



Bright colors and pastel shades combine as multicolored decorations that look like paintings. Gradations of grey, green, brown express the true colors of nature. The revolutionary Colorfive collection uses the most advanced technology of plastic injection and a palette of original colors. With prêt à porter style, and the various colors available, Colorfive matches perfectly any indoor and outdoor environment. Upholstered version, a natural evolution of the Colorfive family, proposed with a soft and pleasant fabric, conveying a sense of classic elegance and quality craftsmanship. Infinite design possibilities.

Colori brillanti e pastello, tinte ton-sur-ton, decori che sembrano dipinti. Gradazioni cromatiche del grigio, del verde, del marrone, che esprimono i colori più veri della natura. La rivoluzionaria collezione Colorfive utilizza la più avanzata tecnologia di iniezione plastica e una palette di colori brillanti. Con il suo stile prêt à porter, e le varie colorazioni a disposizione, si abbina perfettamente a qualsiasi ambiente indoor e outdoor. Evoluzione istintiva della famiglia Colorfive, la versione Imbottita è proposta con un tessuto morbido e piacevole. Una finitura sartoriale per un prodotto ognitempo, che richiama un'eleganza classica ed un artigianato di alta qualità. Infinite possibilità di design.





# Extreme

Stefano Sandonà Design

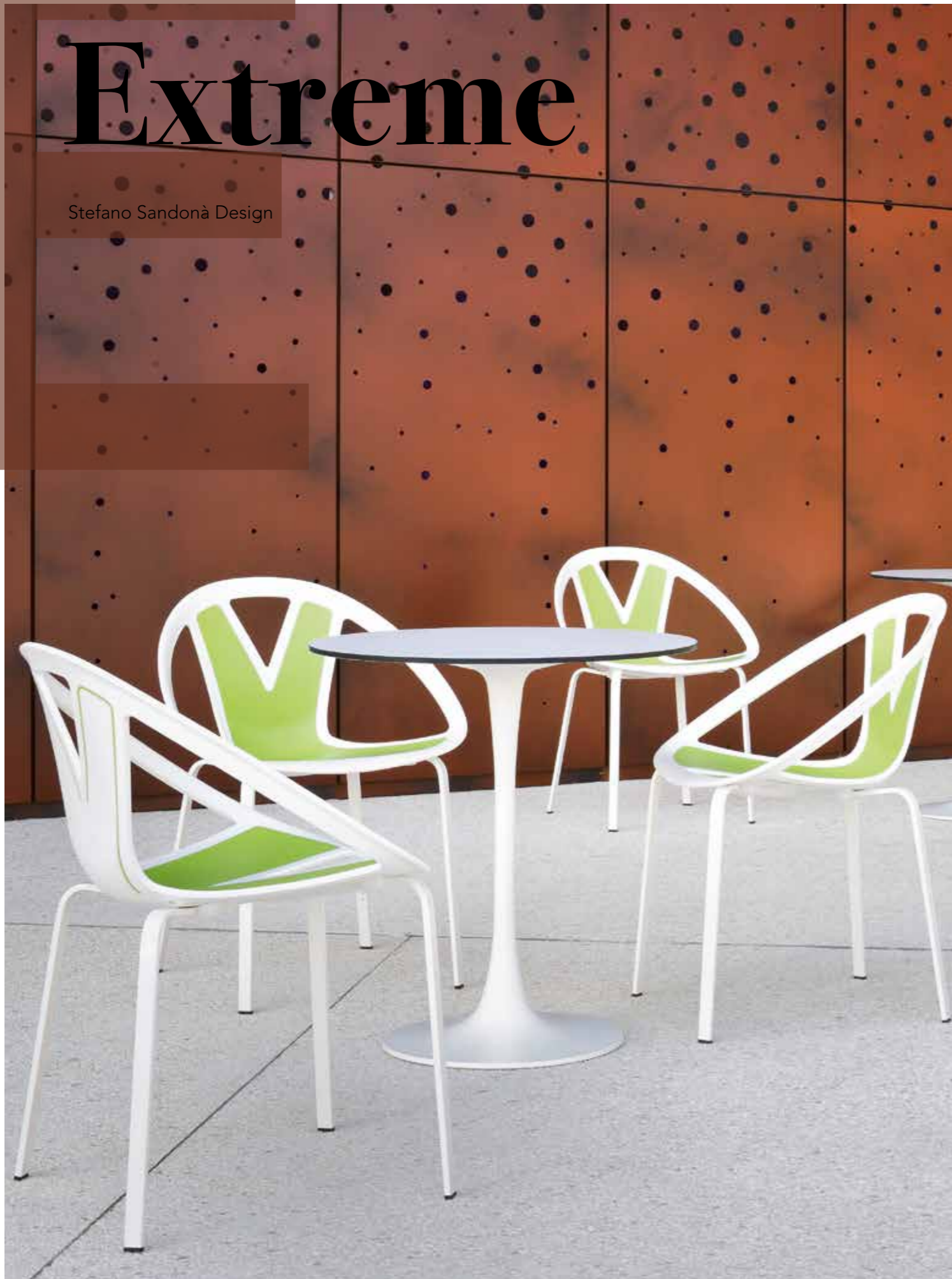

Young, dynamic and creative, a new family of chairs which combines its lightness and strength with an innovative and extrovert design, capable of making any background trendy and special. Extreme features a twin-color shell with chromed or painted for outdoors. Extreme in its essential originality can give a touch of glamour to its location.

Giovane, dinamica e creativa, una nuova famiglia di sedute che con i suoi tratti inconfondibili riesce a sintetizzare leggerezza e robustezza con un design innovativo ed estroverso, capace di rendere di tendenza e speciale qualunque ambiente. Una seduta bicolore in tecnopolimero e un telaio in metallo cromato e verniciato per l'esterno. Extreme nella sua essenziale originalità riesce a donare un tocco di glamour alla location che arreda.



# Alhambra

Stefano Sandonà Design

The unique style and harmony of the geometric texture that draws surfaces, makes Alhambra a chair with a strong personality and an unmistakable sense of form-beauty, thanks also to the development and application of an innovative patented production system. Alhambra is made by a multi-color techno-polymer shell which goes with a variety of frames to make it suitable for solutions, ideas and aspirations for various spaces and very personal tastes.

Lo stile unico e l'armonia della tessitura geometrica che ne disegna le superfici, rende Alhambra una sedia con una forte personalità ed un inconfondibile senso estetico della forma, grazie anche allo sviluppo ed applicazione di un innovativo sistema di produzione brevettato. Alhambra è realizzata con una seduta in tecnopolimero multicolore e una serie di strutture che la rendono adatta a soluzioni, idee e aspirazioni per spazi diversi e gusti molto personali.



interior  
innovation  
award  
cologne 2010



# Alhambra-Eco

Stefano Sandonà Design



New furnishings are made of materials that are more and more refined: from technological to the more traditional, from precious to recover post-consumption materials. To achieve Alhambra-Eco, Gaber started right from materials research, specifically a "Compound-wood" material.

Gaber is always more committed to research and development of eco-friendly products. Whether they are made from eco-friendly production processes, or made with recyclable and eco-friendly materials. Alhambra-Eco has been designed taking as a basic principle the respect for our natural environment: it is composed of two separate units and, despite the goal being secondary, the result has been a contemporary and pleasant design object.

The first part is a twin-color shell, realized using recycled plastics, and sawdust obtained from wood production waste. The second part is the frame, here as well a high-performance recycled structural polymer, joined to wood waste in the form of mixture. This particular material is called wood pulp and uses the same waste from Gaber's production of wooden furniture. The result, obtained from large investments in materials research and new technologies of plastic injections, it is exciting; especially paying attention to the huge amount of materials that can be reused in this type of production cycle.

I nuovi arredi sono realizzati in materiali sempre più ricercati, dai più tecnologici ai più tradizionali, da quelli preziosi a quelli di recupero. Gaber, per realizzare Alhambra-Eco, è partita proprio dalla ricerca sul materiale, nello specifico un "Compound-wood", oltre che alla ricerca di trattamenti particolari, alle più diverse lavorazioni a finiture possibili.

Gaber è sempre più attenta nel realizzare prodotti che siano amici dell'ambiente. Sia che essi siano realizzati con processi produttivi eco-friendly, come di prassi per Gaber, sia che il prodotto stesso venga realizzato con materiali eco-compatibili e riciclabili. Alhambra-Eco è stata realizzata tenendo come principio basilare il rispetto del nostro ambiente naturale. Questa è composta da due unità distinte. La prima parte è una scocca, bi-color, realizzata per mezzo di materiale plastico riciclato e segatura di legno, anch'essa ricavata da scarti di produzione. La seconda parte è il telaio, anche qui un tecnopolimero riciclato ad alte prestazioni strutturali, unito al legno sotto forma di impasto. Questo particolare materiale viene nominato "Compound-wood", ed utilizza gli stessi scarti di lavorazione dei prodotti realizzati da Gaber in legno. Il risultato, frutto di ingenti investimenti nella ricerca dei materiali e in nuove tecnologie per lo stampaggio delle materie plastiche, è entusiasmante, soprattutto rivolgendo l'attenzione alla enorme quantità di materiale che si può riutilizzare in questo tipo di ciclo produttivo.



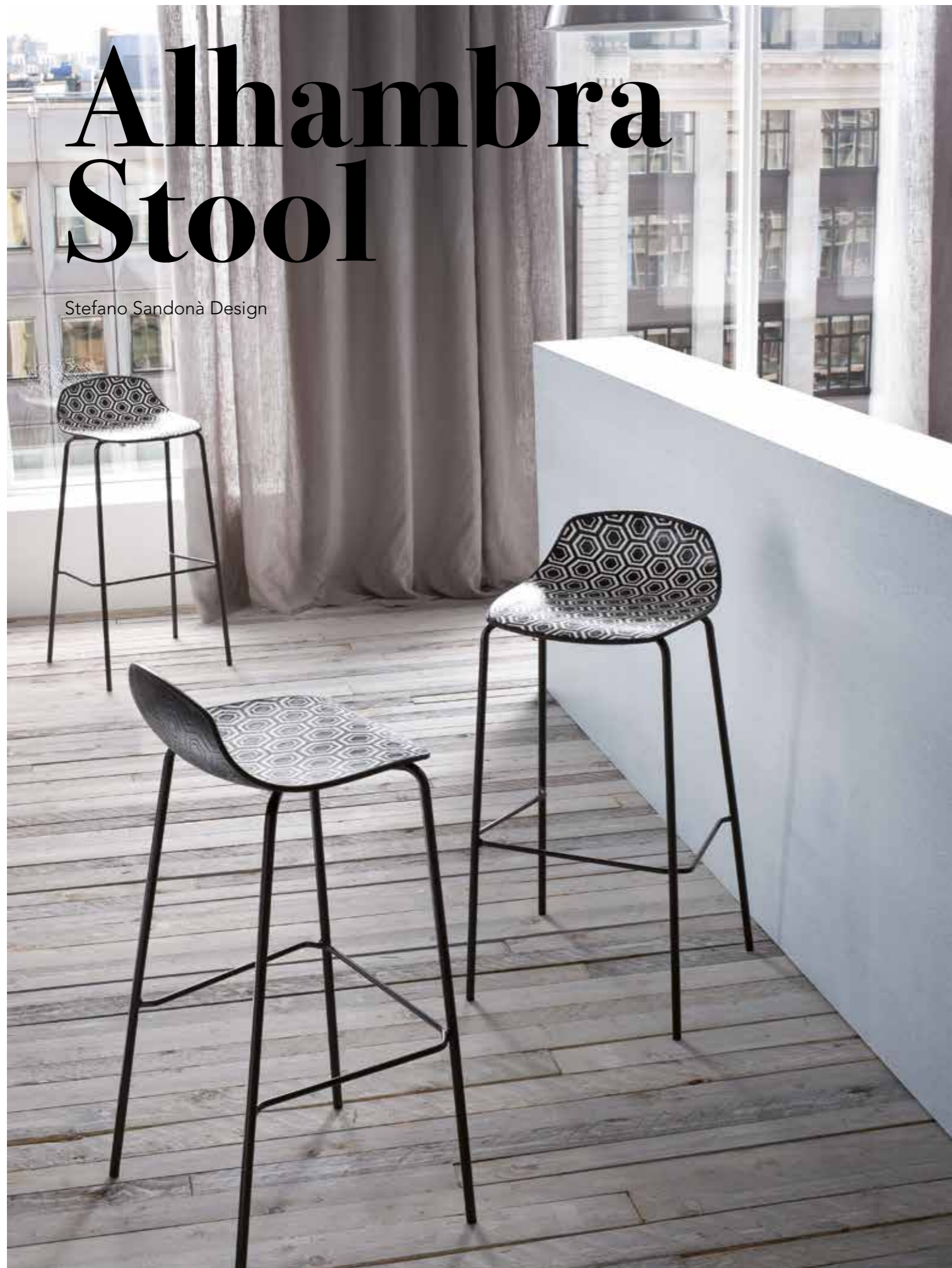

# Alhambra Stool

Stefano Sandonà Design

The unique style and harmony of the geometric texture that draws its surfaces makes Alhambra a barstool with a strong personality and an unmistakable sense of beauty through form, thanks also to the development and application of an innovative patented production process. Alhambra is made of multi-colored technopolymer shells which fit different frames, creating highly personalised barstools suitable to match all manner of concepts and surroundings. The collection is enriched by the new version Alhambra ST Stool, with more generous sizes, made with a new sled frame.

Lo stile unico e l'armonia della tessitura geometrica che ne disegna le superfici, rende la collezione Alhambra uno sgabello con una forte personalità ed un inconfondibile senso estetico della forma, grazie anche allo sviluppo ed applicazione di un innovativo sistema di produzione brevettato. Lo sgabello Alhambra è realizzato con una seduta in tecnopolimero multicolore e una serie di strutture che lo rendono adatto a soluzioni e idee per spazi diversi e gusti molto personali. La collezione si arricchisce della versione Alhambra ST Stool, dalle dimensioni più generose, realizzata con telaio a slitta.



# Dress Alhambra

Stefano Sandonà Design

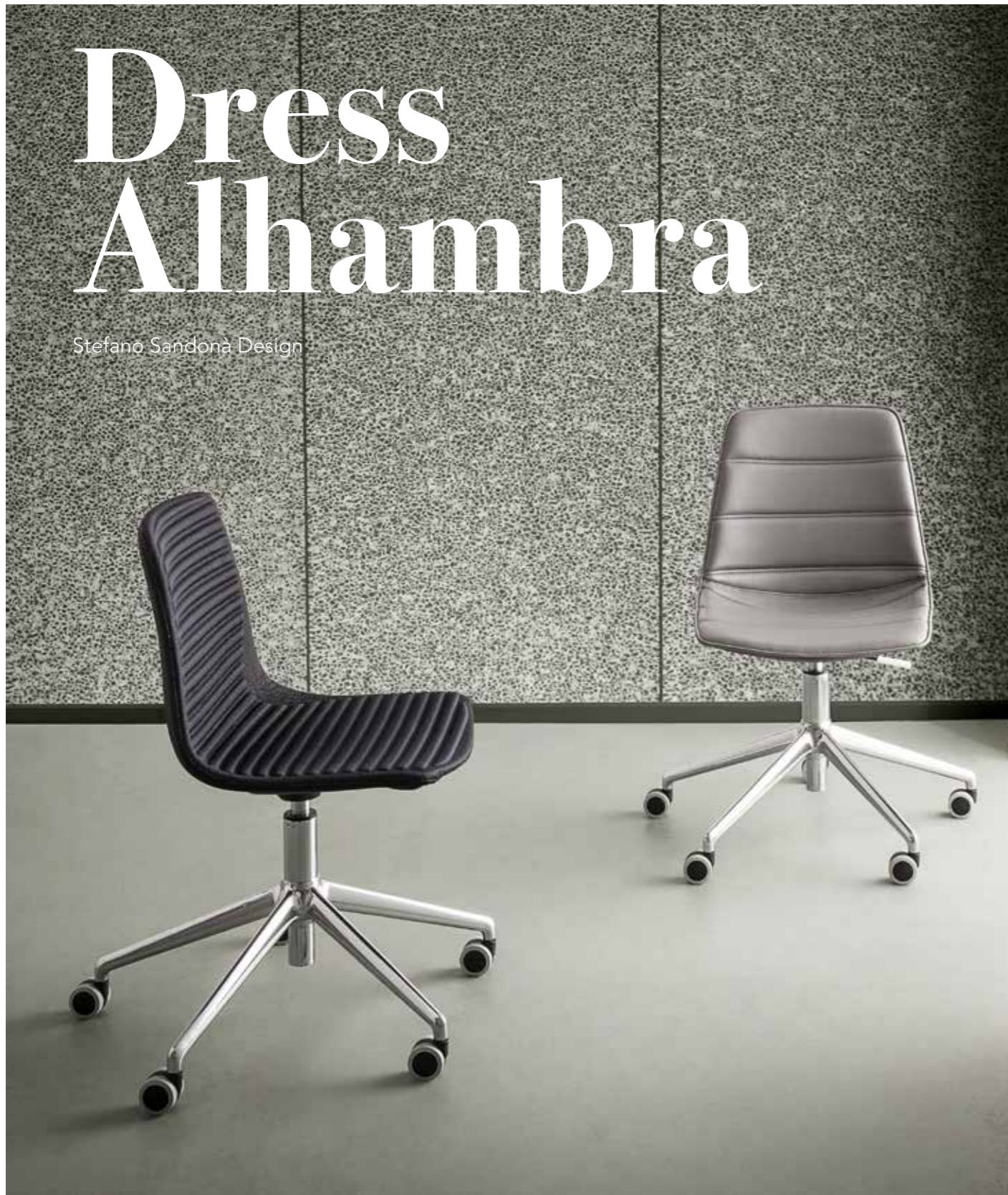

A dedicated covering with fine tailoring, always with great attention to detail. The padding and upholstery are made in two systems, intentionally very different from each other: the first, completely handmade, done in eco-leather finish with parallel horizontal stitching. The second is realized by Gaber through the industrial process of fabric thermoforming, with the supporting areas highlighted by a thick horizontal grid, for better aeration and posture. Two different ways of seeing and designing a product.

Un rivestimento dedicato e una cura sartoriale dei dettagli, sempre con un tratto ricercato. L'imbottitura e la tappezzeria sono realizzate in due sistemi, volutamente estremamente diversi tra loro: il primo, completamente artigianale, realizza la finitura in ecopelle con cuciture orizzontali parallele. Il secondo è realizzato da Gaber attraverso il processo industriale di termoformatura dei tessuti, con le zone di appoggio evidenziate da un fitto reticolo orizzontale, per una migliore aerazione e postura. Due modi diversi di vedere e concepire un prodotto.

# Dress Alhambra Stool

Stefano Sandonà Design

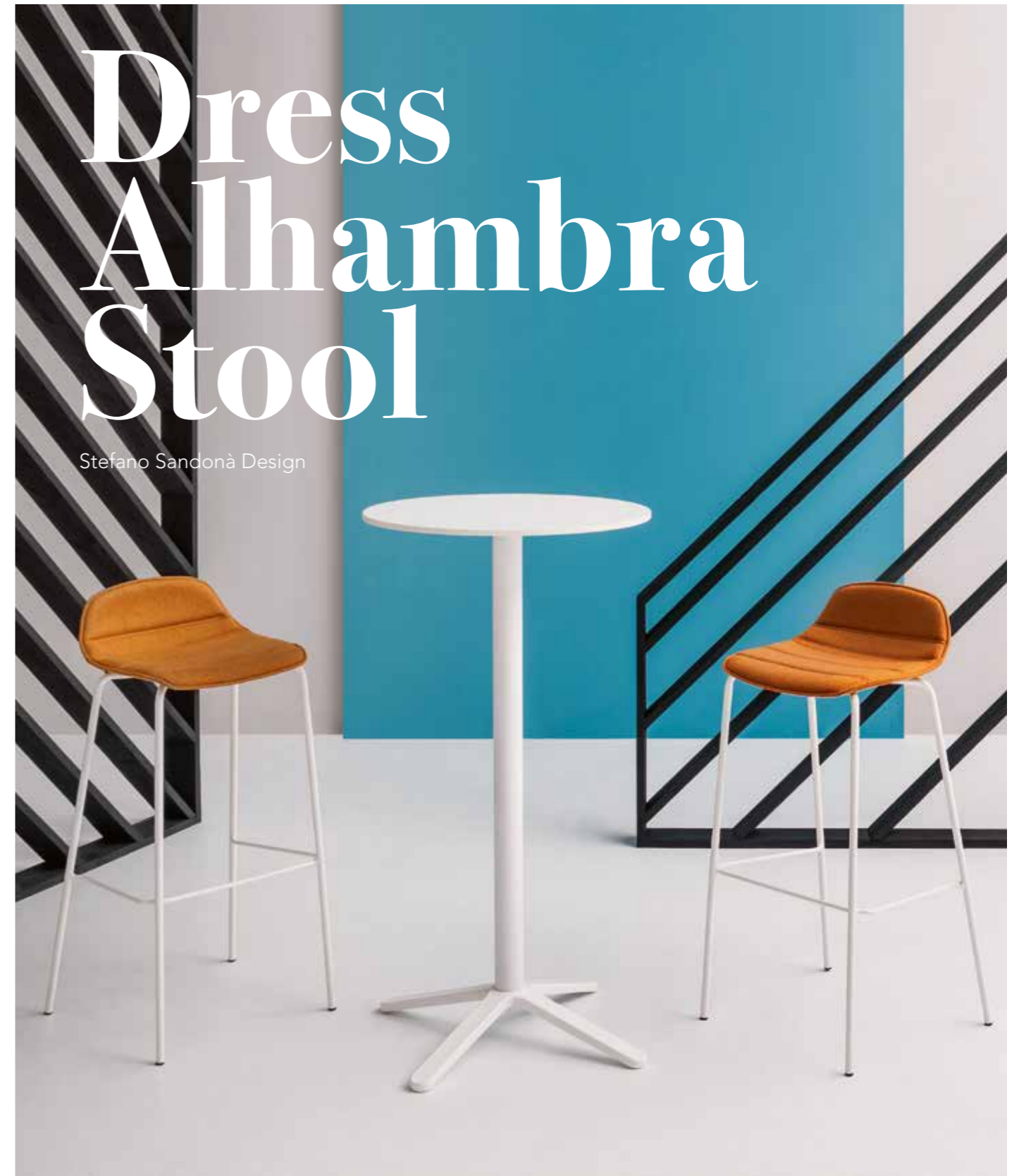

A finely tailored dedicated cover always with great attention to detail. The skilfully executed padding and upholstery, with feature horizontal stitchwork, enhance this multi-purpose stool.

Un rivestimento dedicato e una cura sartoriale dei dettagli, sempre con un tratto ricercato. L'imbottitura e la tappezzeria realizzate artigianalmente, con cuciture orizzontali parallele, impreziosiscono questo polivalente sgabello.

# Kalipa

Studio Eurolinea Design

Kalipa is a family of practical, stackable chairs, made from a combination of fully recyclable plastic. The soft and flexible backrest, and the generous seat characterized by the innovative texture, give Kalipa an enviably comfortable sit. Chairs and stools, with or without arms, are available in full-color and twin-color combinations and are suitable both for indoor and outdoor environments. Also available with upholstered seat and arms, for additional comfort.

Kalipa è una famiglia di pratiche sedute, impilabili, realizzate dalla combinazione di materiali plastici totalmente riciclabili. Lo schienale, morbido e flessibile, e l'ampio sedile dall'innovativa texture, donano all'oggetto un'invidiabile confortevole seduta. Seduta e sgabello, con e senza braccioli, sono funzionali sia nell'ambiente indoor che outdoor, disponibili in diverse combinazioni di colori full-colour e bi-colour. Per un maggiore comfort è disponibile anche la versione rivestita in tessuto ed ecopelle.



# Kalipa Stool

Studio Eurolinea Design



Kalipa is a multi-purpose collection of stools and chairs, suitable for both indoor and outdoor use. These well-sized stools are available in many single or twin-color combinations, optionally with armrests. Kalipa is made entirely of tough techno-polymer and is fully recyclable. For additional comfort, the seat is also available upholstered in leather or fabric.

Kalipa è una collezione di sgabelli e sedute polifunzionali, adatta all'uso sia indoor che outdoor. Gli sgabelli, dalle dimensioni generose, sono disponibili in varie combinazioni di colori full-color e bi-color, anche con bracciolo. Il prodotto, realizzato integralmente in tecnopolimero ad alta resistenza, è totalmente riciclabile. Per un maggiore confort, è disponibile anche la versione con seduta imbottita e rivestita, in ecopelle o tessuto.



# Big Bang

Stefano Sandonà & Sabrina Bettini Design



Big Bang is a chair that uses digital language in order to create an explosion of colors. An innovative graphic solution, thanks to the development and application of an innovative patented production system. Big Bang is made of a multi-colored techno-polymer shell and a chromed or white-painted frame.

Big Bang è una sedia che usa il linguaggio digitale per dare vita ad un'esplosione di colori e alla decostruzione formale della sedia tradizionale. Una soluzione grafica innovativa grazie anche allo sviluppo e all'applicazione di un innovativo sistema di produzione brevettato. Big Bang è realizzata con una scocca in tecnopolimero multicolor e da un telaio in metallo cromato o verniciato bianco.





# Blog

Stefano Sandonà Design



An allusion to the message window of online diaries, Blog combine the sweetness of shape to the lightness of structure, creating a young and practical chair.

Un'allusione alla finestra di messaggi dei diari on-line, Blog unisce la dolcezza della forma alla leggerezza della struttura per far sorgere una sedia pratica e giovane.

**GOOD DESIGN AWARD 2012**  
OF CHICAGO ATHENAEUM : MUSEUM OF ARCHITECTURE AND DESIGN



# Blog Stool

Stefano Sandonà Design



Blog combines the sweetness of its shape with the lightness of its frame: the result is a practical and youthful stool. The wide range of Blog twin-color stools allows varied use and easy adaptability, thanks to the range of available colors and the upholstered versions.

Blog unisce la dolcezza della forma alla leggerezza della struttura, per far sorgere uno sgabello pratico e giovane. La vasta gamma di sgabelli Blog, realizzati in due diversi colori, permette un ampio utilizzo e una facile adattabilità, grazie anche alla vasta gamma di colori disponibili. Blog è disponibile anche nella versione imbottita e tappezzata.



# Moon

Studio Eurolinea Design



The Moon collection is extremely durable and has excellent resistance to varying weather conditions. Available in a wide range of colors, stackable, lightweight and durable, this versatile chair is able to adapt both to residential and contract environments. The high strength, obtained by a metal co-injected frame, ensures a long product life, even after heavy-duty use.

La collezione Moon resiste alla fatica e non teme gli agenti atmosferici. Disponibile in una vasta gamma di colori, impilabile, leggera e resistente, questa versatile seduta è capace di adattarsi sia all'uso residenziale che contract. L'elevata resistenza, ottenuta per mezzo di un telaio metallico co-iniettato, garantisce un lunga durata del prodotto, anche in condizioni di uso intensivo.

# Venezia

Studio Eurolinea Design



Venezia's simple, light design makes it suitable for any environment with pleasantly aesthetic and functional results. The solid structure, stemming originally from the "Moon" chair, allows the re-use of waste products. Well-padded and expertly upholstered by using eco-leather, Venezia is available in five different finishes, for a wide color customization.

Venezia è un'oggetto dal design semplice e leggero, capace di inserirsi in ogni ambiente con piacevoli risultati estetici e funzionali. La solida struttura, derivante dal prodotto "Moon", permette il riutilizzo degli scarti di lavorazione. Ben imbottita e rivestita in ecopelle con cura artigianale, Venezia è disponibile in cinque colori, per un'ampia personalizzazione cromatica.

# Over

Studio Eurolinea Design



An award-winner 2004 for its innovative vision, the Over chair is the progenitor of twin-color configurations in the contract sector. A timeless design, capable of inspiring and also adaptable to the most demanding environments. Seat and back lay on a structure of elastomer techno-polymer, which ensures extremely thin lines without affecting strength and stability. The chair is stackable, lightweight and available in a wide range of colors.

The "Over" range is completed with the option of seat padding and upholstery, for extra comfort. Over Plus is available in eco-leather, in five different colors.

Premiata già nel 2004 per l'innovativa visione, la seduta Over è la progenitrice dell'utilizzo di configurazioni bi-colori nel settore contract. Un design senza tempo, capace di entusiasmare ed adattarsi anche agli ambienti più esigenti. Seduta e schienale poggiano su di una struttura in tecnopolimero elastomero, che garantisce linee estremamente sottili senza però intaccare resistenza e stabilità. La seduta è impilabile, leggera e disponibile in una vasta gamma di colori.

La seduta "Over" si completa con imbottitura e rivestimento della seduta, per un piacevole confort aggiuntivo. Over Plus è disponibile con rivestimento in eco pelle.



# Flap

Studio Eurolinea Design



Technique and Design come together in the new Flap folding chair, designed by Eurolinea Studio. Entirely in technopolymer, and therefore completely recyclable, Flap is distinguished by its great comfort, resistance and stability. Flap folds easily into an extremely limited space, thanks to a patented system that also allows highly practical stackability. Easy to clean and also suitable for outdoor environments, Flap is the ideal folding chair for major events, ceremonies, meetings, or in settings where frequent cleaning is required.

Tecnica e Design si fondono nella nuova sedia pieghevole Flap, disegnata dalla studio Eurolinea. Realizzata integralmente in tecnopolimero, e quindi completamente riciclabile, questa seduta si distingue per il grande comfort e per la grande resistenza e stabilità. Flap si ripiega facilmente in uno spazio estremamente limitato, grazie ad un sistema brevettato che ne permette anche una pratica accatastabilità. Facile da pulire ed adatta anche ad ambienti outdoor, Flap è la seduta ideale per grandi eventi, cerimonie, meeting, oppure in ambienti dove sia necessari una frequente sanificazione.



# Compact

Studio Eurolinea Design



Lightness is an opinion. It can be light and yet weigh like lead. It can be light and as tough as steel. In Gaber chairs this assumes precise values of resistance, soft elements, durability, easy transportation. We help you with furniture that can be easily moved or put away. Compact, Gaber's folding chair, represents all these features. Compact stands out for its anodized aluminum structure and special polymer details; all folded in a minimum space of 35 mm. This folding chair works perfectly outdoors or in meeting and conference rooms, thanks to practical linking devices. For easy stacking and transport, Compact can be equipped with wall-hooks or with a practical dolly (in two different sizes: for seven or sixteen chairs each).

La leggerezza è un'opinione. Si può essere leggeri e pesare come il piombo. Si può essere leggeri e tenaci come l'acciaio. Negli oggetti Gaber ciò assume valori precisi: resistenza, elementi soft, durabilità, facile trasportabilità. Vi aiutiamo con arredi che si possono spostare o riporre con estrema facilità. Compact, la sedia pieghevole di Gaber, rappresenta tutto ciò. Compact si contraddistingue per il profilo in alluminio anodizzato e i particolari in tecnopolimero; il tutto richiudibile in un minimo ingombro di 35mm. La sedia pieghevole, adatta anche all'uso per esterni, può essere accessoriata con ganci a parete o con pratici carrelli per facilitarne il trasporto (in due diverse dimensioni: per sette o sedici sedie). Oppure con pratici ganci per riporre le sedie in linea nel caso di sale conferenza o meeting rooms.



# Prisma

Studio Eurolinea Design



The overriding characteristic of this piece is weight, it's extremely light. A very modern chair, totally recyclable, created entirely from a new innovative material. Suitable for outdoors, clean design, with a classic touch, slightly contemporary, the chair has really a good look. Prisma blends beautifully into its surroundings.

La caratteristica predominante di questo oggetto è il peso, la sua estrema leggerezza. Una sedia molto moderna, totalmente riciclabile, creata interamente da un nuovo innovativo materiale. Adatta anche all'esterno, dal design pulito, a tratti classico, a tratti contemporaneo, è un design che piace. E che si adatta con brio all'ambiente che la circonda.



# Together

Marc Sadler Design



Together: Table and Chair collection, characterized by a combination of wood and techno-polymer. Aesthetically, an unusual pairing, because they constitute a real technical "tour de force". Opposites attract: the classic solid wood, natural and warm, embracing shiny and transparent polymer, a spokesperson of modernity. The soft, clean design along with the range of colors for seat and back make Together suitable for any context.

Together: collezione di sedie e tavoli caratterizzati dall'accostamento di legno e termoplastico stampato ad iniezione. Esteticamente un binomio insolito, anche perché vero "tour de force" tecnico. Opposti che si attraggono: il classico massello, naturale e caldo, sposa il tecnopolimero lucido e trasparente, portavoce della modernità. La linea pulita e morbida rende questi elementi inseribili in ogni contesto. La disponibilità dei colori per seduta e schienale corona una proposta indubbiamente trasversale.

GOOD DESIGN AWARD 2011

OF CHICAGO ATHENAEUM : MUSEUM OF ARCHITECTURE AND DESIGN

interior innovation award 2012 Winner





# Sunlounger Doge

Forsix Design



The Doge and Podio sun-lounger collections are born from the need to enhance outdoor environments with innovative, contemporary and simple design. The result obtained is quite stunning: the surface dedicated to relaxation turns out to be clean and floating, suspended in mid-air, minimizing volumes. Steel, aluminum and techno-polymer, used in a correct balance thanks to state-of-the-art technology, have created products of extreme lightness and manageability, as well as being supremely resistant and durable.

These sun-beds are equipped with backrests adjustable to 5 positions and practical castors for easy transport; Doge and Podio also stack compactly, which helps in terms of transport as well as reducing the necessary storage space.

The **Doge** sun-bed uses high-strength techno-polymer on the relaxation surface that can withstand intensive use. The blend of polymers guarantees great flexibility of the surface, which, adapting ergonomically to body shapes, remains comfortable even without cushions, in addition to assuring breathability and allowing moisture and water to escape, avoiding stagnant deposits. The material used is anti-tear, resistant to salt, UV rays, atmospheric agents and swimming pool chlorine.

Le collezioni di lettini Doge e Podio nascono dalla necessità di migliorare gli ambienti outdoor con un design innovativo, contemporaneo e semplice. Il risultato ottenuto è sbalorditivo: la superficie dedicata al relax risulta essere pulita e fluttuante, sospesa a mezz'aria, riducendo al minimo i volumi occupati dagli oggetti. Acciaio, alluminio e tecnopolimero, utilizzati in un corretto equilibrio grazie alla tecnologia high-end impiegata, hanno creato prodotti ai vertici della leggerezza e maneggevolezza, oltre che estremamente resistenti e durevoli.

I lettini sono dotati di schienale regolabile in 5 posizioni e di pratiche rotelline per un facile trasporto; Doge e Podio sfruttano inoltre una grande capacità di impilaggio, che consente sia di migliorare i trasporti che diminuire le aree dedicate all'eventuale stoccaggio dei prodotti. Il lettino **Doge** utilizza nella superficie di relax un tecnopolimero ad alta resistenza, in grado di resistere ad un uso intensivo. Il blend di polimeri utilizzati garantisce una grande flessibilità della superficie, che, adattandosi ergonomicamente all'utilizzatore, rimane confortevole anche senza l'utilizzo di qualsivoglia cuscino, oltre a permettere la traspirabilità e consentire ad umidità e acqua di fuoriuscire, evitando depositi stagnanti. Il materiale utilizzato è anti-strappo, resistente a salsedine, raggi UV, agenti atmosferici e al cloro delle piscine.

# Sunlounger Podio

Forsix Design



The Doge and Podio sun-lounger collections are born from the need to enhance outdoor environments with innovative, contemporary and simple design. The result obtained is quite stunning: the surface dedicated to relaxation turns out to be clean and floating, suspended in mid-air, minimizing volumes.

Steel, aluminum and techno-polymer, used in a correct balance thanks to state-of-the-art technology, have created products of extreme lightness and manageability, as well as being supremely resistant and durable. These sun-beds are equipped with backrests adjustable to 5 positions and practical castors for easy transport; Doge and Podio also stack compactly, which helps in terms of transport as well as reducing the necessary storage space.

The **Podio** sun-bed uses synthetic fiber on the relaxation surface, consisting of a weave of polyester fibers covered in PVC, able to withstand compression stress, tears, atmospheric agents, swimming pool chlorine, salt and UV rays. This material, thanks to its micro-holes, is breathable and allows moisture and water to escape without creating stagnant deposits.

Le collezioni di lettini Doge e Podio nascono dalla necessità di migliorare gli ambienti outdoor con un design innovativo, contemporaneo e semplice. Il risultato ottenuto è sbalorditivo: la superficie dedicata al relax risulta essere pulita e fluttuante, sospesa a mezz'aria, riducendo al minimo i volumi occupati dagli oggetti.

Acciaio, alluminio e tecnopolimero, utilizzati in un corretto equilibrio grazie alla tecnologia high-end impiegata, hanno creato prodotti ai vertici della leggerezza e maneggevolezza, oltre che estremamente resistenti e durevoli. I lettini sono dotati di schienale regolabile in 5 posizioni e di pratiche rotelline per un facile trasporto; Doge e Podio sfruttano inoltre una grande capacità di impilaggio, che consente sia di migliorare i trasporti che diminuire le aree dedicate all'eventuale stoccaggio dei prodotti.

Il lettino **Podio** utilizza nella superficie di relax una fibra sintetica, costituito da un intreccio di fibre di poliestere ricoperte da una cover di Pvc, in grado di resistere a sforzi di compressione, strappi, agenti atmosferici, cloro utilizzato nelle piscine, salsedine e raggi UV. Questo materiale, grazie ai suoi micro-fori, è traspirante e consente all'umidità e all'acqua di fuoriuscire senza creare depositi stagnanti.

# Link

Stefano Sandonà Design

Metal Link Collection of chairs, lounge and stools are iconic for a lightweight aesthetic, yet elegant look. The intersections of the various elements of the frame also serves as a primary aesthetic element. Our Link collection it is made of a solid steel frame, that fits perfectly indoor and out.

Link chairs and stools are also stackable, comes with or without armrests, and is available in many fashion colors.

Le sedute in metallo della collezione Link sono iconiche per estetica ed eleganza. Le intersezioni dei vari elementi della struttura fungono anche da elemento estetico primario. Le sedute della collezione Link sono realizzate da un telaio di solido acciaio, che si adatta perfettamente ad ambienti interni che per uso esterno. Sedie e sgabelli Link sono anche impilabili e forniti nelle versioni con e senza braccioli, in molte colorazioni alla moda.





# Link Stool

Stefano Sironi Design

Metal Link Collection of chairs, lounge and stools are iconic for a lightweight aesthetic, yet elegant look. The intersections of the various elements of the frame also serves as a primary aesthetic element. Our Link collection it is made of a solid steel frame, that fits perfectly indoor and out. Link chairs and stools are also stackable, comes with or without armrests, and is available in many fashion colors.

Le sedute in metallo della collezione Link sono iconiche per estetica ed eleganza. Le intersezioni dei vari elementi della struttura fungono anche da elemento estetico primario. Le sedute della collezione Link sono realizzate da un telaio di solido acciaio, che si adatta perfettamente ad ambienti interni che per uso esterno. Sedie e sgabelli Link sono anche impilabili e forniti nelle versioni con e senza braccioli, in molte colorazioni alla moda.



# Spyker

Studio Eurolinea Design



The Spyker collection is lightweight and stackable, cunningly manufactured with colourfast and non-deformable materials, the end result strength and resistance in all types of environment.

Simplicity and comfort: suited to all settings, Spyker works especially elegantly in large-scale contract installations, thanks to the bright choice of colours.

La collezione Spyker è leggera ed impilabile, il complesso sistema produttivo e l'utilizzo di materiali inalterabili la rendono robusta e resistente agli agenti atmosferici. Semplicità e Comfort: adatta a tutti gli ambienti, Spyker si presta con eleganza all'utilizzo in grandi installazioni, grazie anche alla vivace paletta di colori.



# Spyker Stool

Studio Eurolinea Design

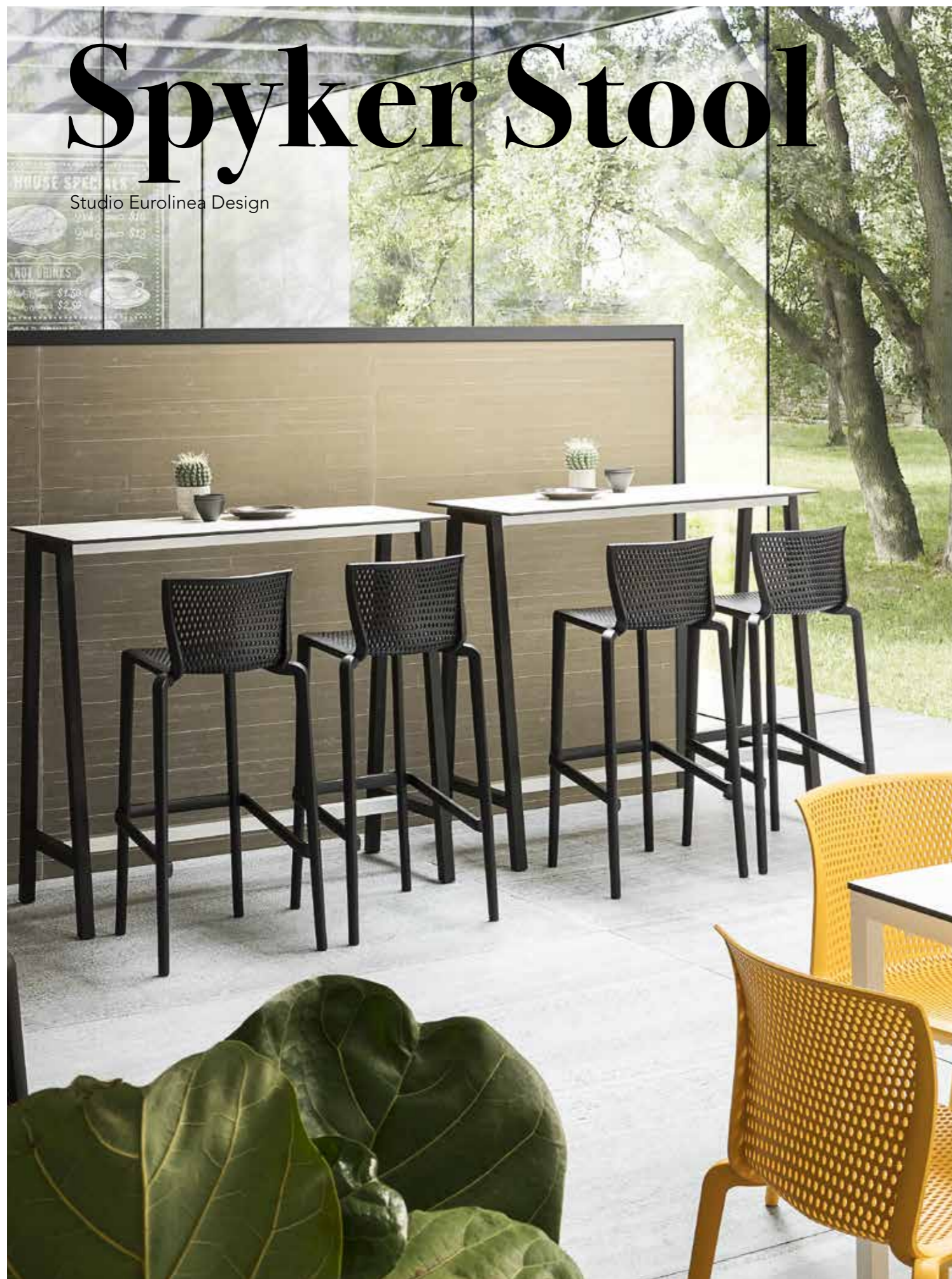

The Spyker collection is lightweight and stackable, cunningly manufactured with colourfast and non-deformable materials, the end result strength and resistance in all types of environment. Simplicity and comfort: suited to all settings, Spyker works especially elegantly in large-scale contract installations, thanks to the bright choice of colours.

La collezione Spyker è leggera ed impilabile, il complesso sistema produttivo e l'utilizzo di materiali inalterabili la rendono robusta e resistente agli agenti atmosferici. Semplicità e Comfort: adatta a tutti gli ambienti, Spyker si presta con eleganza all'utilizzo in grandi installazioni, grazie anche alla vivace paletta di colori.



# Minush

Studio Eurolinea Design

Minush is an elegant collection intended for outdoor use, with a comfy look and generous proportions. This lively armchair is also available for lounging around in its Relax version, and was developed with contemporary lifestyles in mind, to envelope you in a comfortable embrace. Featuring surprising stackability and a cushion to extend the versatility of use, Minush combines its hard-wearing materials with the lively choice of colourways, to become a key player in numerous settings.

Minush, una collezione elegante ideata per l'outdoor, è caratterizzata dal look confortevole e dalle generose dimensioni. Questa vivace poltroncina, disponibile per l'ozio anche nella versione Relax, è stata progettata per i lifestyle più contemporanei, per avvolgervi in un abbraccio confortevole. Arricchita da una sorprendente impilabilità e da un cuscino che ne esalta la versatilità di utilizzo, Minush abbina i materiali inalterabili che la compongono al look vivace dei colori disponibili, per essere la discreta protagonista di innumerevoli destinazioni d'uso.



# Grand Minush

Studio Eurolinea Design



The Grand Minush collection is intended for outdoor use and has been designed with contemporary living in mind. The generous proportions envelope you comfortably, and can be enhanced through cushions that extend the versatility of use. Gaber's 2K plastic injection procedure, and the steel and aluminium inserts that form the core, make Grand Minush sturdy and durable; the combination of colourfast and non-deformable materials with the vibrant colourways available make for easy fitting in to the most modern of hospitality environments.

La collezione Grand Minush, ideata per l'outdoor, è stata progettata per i lifestyle più contemporanei. Le generose dimensioni avvolgono in un abbraccio confortevole, eventualmente accentuato dai cuscini che ne esaltano la versatilità di utilizzo. Il processo di iniezione plastica 2K e gli inserti in alluminio ed acciaio con i quali viene realizzata, la rendono robusta e durevole; l'abbinamento di materiali inalterabili al look vivace dei colori disponibili crea un prodotto facilmente adattabile agli ambienti dell'ospitalità più moderna.

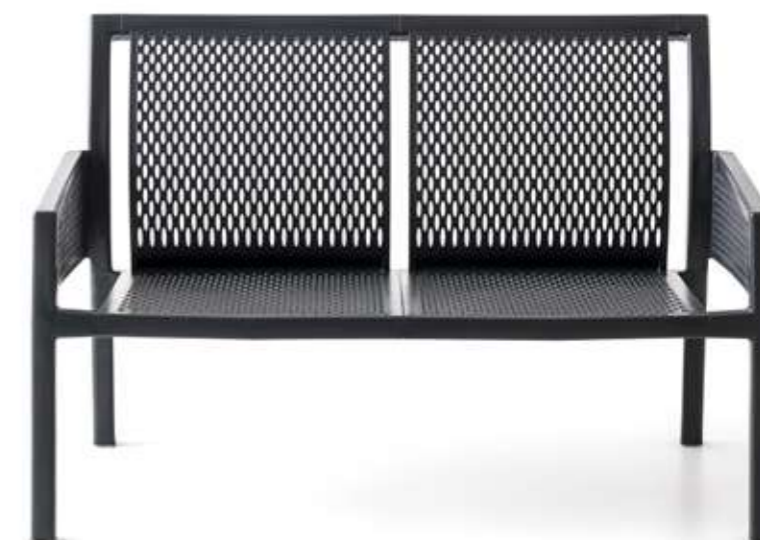



# Conga

Studio Eurolinea Design



The Conga modular lounge system is a practical collection suitable for both indoor and outdoor environments. In addition to its innate comfort, Conga is the result of careful design that allows modular and always elegant use. The simplicity of the techno-polymer structure, together with the armrest and the backrest made of co-molded metal-polymer, allow an infinite variety of configurations. Among Conga's qualities are its lightness, which makes for easy positioning, the strength of the modular units, the resistance to atmospheric agents, Quick Dry Foam padding and the fully removable cushion covers, all of which combine to make this modern collection suitable for use in refined contract scenarios.

Il sistema lounge modulare Conga è una pratica collezione adatta sia ad ambienti indoor che outdoor. Oltre alle innate doti di comfort, Conga è il risultato di un'attenta progettazione che ne permette un utilizzo modulare e sempre elegante. La semplicità della struttura in tecnopolimero, unita al bracciolo e allo schienale realizzati in co-stampaggio metallo-polimero, permettono un'infinita varietà di configurazioni. Tra le doti di Conga vi è la leggerezza, che ne determina un facile posizionamento, la robustezza dei moduli, la resistenza agli agenti atmosferici, l'imbottitura in Quick Dry Foam e la totale sfoderabilità dei cuscini, che rendono adatta questa moderna collezione ad un utilizzo in ambienti contract di spiccata raffinatezza.



# Avenica

Favaretto & Partners Design

Lightness, freshness and simplicity distinguish Avenica: an innovative and ambitious project, designed for every single sitting situation. The thin and sturdy mesh of seat and back make it ideal and fresh for intensive use, the lightness and stackability make it practical, and the patented construction system makes it durable and environmentally sustainable. Smart and functional, Avenica is the ideal furnishing solution for any space, even outdoors, offering complete freedom of composition and color combination. Avenica is durable and easy to clean: all in the name of beauty and sophisticated simplicity.

La leggerezza, la freschezza e la semplicità contraddistinguono Avenica, un progetto innovativo ed ambizioso, pensato per tutte le singole occasioni in cui trascorriamo del tempo seduti. La sottile e resistente trama di seduta e schienale la rendono perfetta per l'uso intensivo, la leggerezza e l'impilabilità la rendono pratica, il sistema di costruzione brevettato la rende inalterabile ed eco-sostenibile. Elegantemente funzionale, Avenica arreda e risolve qualsiasi spazio, anche all'aria aperta, offrendo una completa libertà di composizione e di abbinamento cromatico. Avenica è resistente e facile da pulire: il tutto nel segno della bellezza e di una ricercata semplicità.



# Panama

Stefano Sandonà Design

Technological innovation and extensive research in the use of materials create this chair and stool collection, with soft lines and contemporary design. Internationally recognized for the unique design, Panama is also available with an upholstered seat and/or back.

Innovazione tecnologica e grande ricerca nell'utilizzo dei materiali danno vita a questa collezione di sedie e sgabelli, dalle linee morbide ed attuali. Riconosciuta a livello internazionale per il design unico, Panama è disponibile anche con seduta e/o schienale imbottiti.



# Panama Stool

Stefano Sandonà Design



Panama adds distinctive character to any modern or classic environment. This collection of stools and chairs, made of durable high quality materials, is characterized by contemporarily soft lines, generous sizes, and various fun colors. Also available with comfortable armrests or a padded and upholstered seat and /or backrest. Let your creativity run loose: Panama is the right choice.

Panama aggiunge un carattere distintivo a qualsiasi arredamento moderno e classico. Questa collezione di sgabelli e sedute, realizzata con materiali durevoli, di alta qualità e resistenza, è caratterizzata dalle linee morbide ed attuali, dalle dimensioni generose, dai vari colori gioiosi. E' disponibile inoltre la versione con comodi braccioli o imbottita e rivestita nella seduta e/o schienale. Liberate la vostra creatività, Panama è la scelta giusta.



# Place

Favaretto & Partners Design

The Place collection, designed by Studio Favaretto & Partners, is not born out of necessity, but because it's a dream come true. The charm of comfort: the sinuous forms expressed by polyurethane padding inside the finest covers and surrounded by an architectural structure in tubular steel. Place is ideal for creating stunning hospitality settings.

La collezione Place dello Studio Favaretto & Partners, non nasce per necessità, ma perché la si sogna. Il fascino del comfort: le forme sinuose espresse da una imbottitura in poliuretano, contenuta nei rivestimenti più raffinati, circondate da una struttura architettonica in tubolare e profilato di acciaio. Place si presta a creare sorprendenti scenografie nell'ambito dell'accoglienza, della collettività e dell'attesa.

GOOD  
DESIGN  
AWARD  
2016

OF CHICAGO  
ATHENAEUM :  
MUSEUM OF  
ARCHITECTURE  
AND DESIGN



# Grand Place

Favaretto & Partners Design



The Place collection, designed by Studio Favaretto & Partners, is not born out of necessity, but because it's a dream come true. The charm of comfort: the sinuous forms expressed by polyurethane padding inside the finest covers and surrounded by an architectural structure in tubular steel. Place is ideal for creating stunning hospitality settings.

La collezione Place dello Studio Favaretto & Partners, non nasce per necessità, ma perché la si sogna. Il fascino del comfort: le forme sinuose espresse da una imbottitura in poliuretano, contenuta nei rivestimenti più raffinati, circondate da una struttura architettonica in tubolare e profilato di acciaio. Place si presta a creare sorprendenti scenografie nell'ambito dell'accoglienza, della collettività e dell'attesa.



# Social-ize

Studio Eurolinea Design



Social-ize is a collection of modular upholstered seating units, suitable for environments that want to offer high comfort in reduced spaces. The modular benches are covered on all sides and can thus be arranged against walls, or in the center of a room; you can also make the practical double-side version, with the individual modules resting on each other with the backrest. The sturdy patented tubular frame structure, made of aluminum, steel and techno-polymer, in addition of all the available finishes in endless textures and fabrics, make the module perfectly suited to the severe demands of the hospitality settings.

Social-ize è una collezione di sedute imbottite modulari, adatte per ambienti che desiderano offrire un alto confort contenendo gli spazi. Le panche modulari, grazie al rivestimento su tutti i lati, si possono disporre appoggiate lateralmente a parete, o al centro di una stanza; è possibile realizzare anche la pratica versione bifacciale, con i singoli moduli appoggiati l'uno all'altro con lo schienale. La robusta struttura brevettata in telaio tubolare, realizzata in alluminio, acciaio e tecnopolimero e le finiture disponibili in infinite trame e tessuti, rendono il modulo perfettamente adatto alle severe esigenze dell'ospitalità.



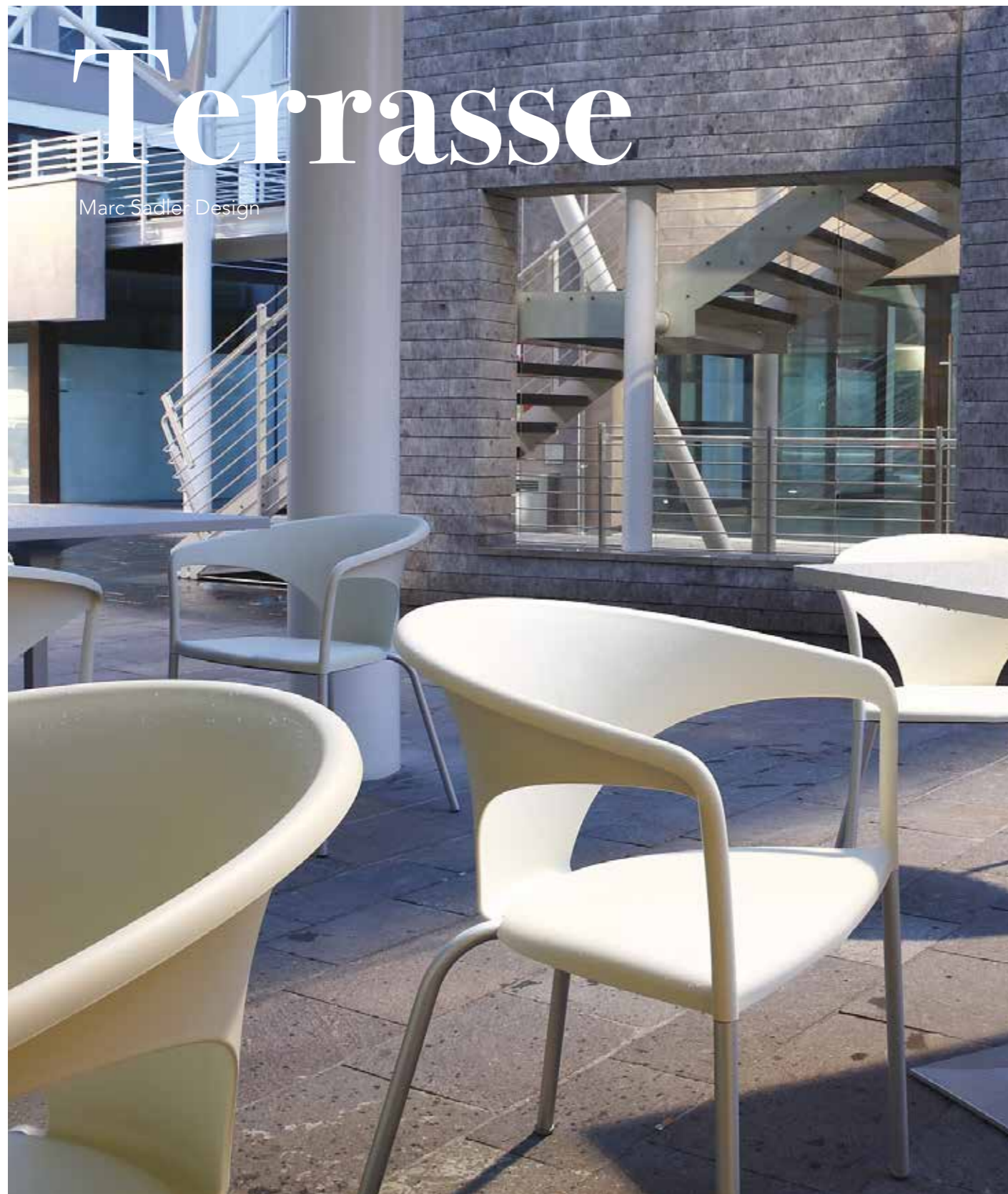

# Terrasse

Marc Sadler Design

The design of the chair recalls sinuous forms, elegant and at the same time aggressive, thereby conferring on it a strong identity. A modern take on classical shapes, which instantly enhances Terrasse's standing and quality. Suitable for indoors and out, Terrasse is lightweight and stackable.

Il design della sedia si rifà a forme sinuose, eleganti ed al tempo stesso aggressive, conferendo in tal modo all'oggetto una forte identità. Una proposta in chiave moderna delle forme classiche che conferisce al prodotto un alto standard di qualità percettibile. Adatta ad uso indoor e outdoor, Terrasse è leggera e impilabile.



# Harmony

Studio Eurolinea Design

Harmony is the synthesis between classic and contemporary, the soft and elegant lines are enhanced by a wide range of colors and versions, as well as the padded and upholstered seat options. The welcoming shape, a wide and comfortable seat and various available versions, make Harmony versatile and ideal in every environment.

Sintesi di gusto classico e contemporaneo, Harmony presenta linee morbide ed eleganti, impreziosite da una vasta gamma di colori e strutture, oltre alla possibilità di rivestire la seduta per un piacevole confort. La forma accogliente, una seduta ampia e le varie versioni disponibili, rendono Harmony una seduta versatile ed utilizzabile in ogni proposta d'arredo.



# Iris

Studio Eurolinea Design



With Made in Italy design and a solid structure, our Iris chairs are built to last. With an injected high-resistance techno-polymer shell and our metal-polymer co-injected patented legs, we are able to provide a solid and plating chair. Iris ensures optimum resistance to atmospheric conditions, salt spray, fungi, insects, even in extreme conditions. It also provides exceptional resistance to environmental stresses: a perfect solution for high-traffic interior and exterior settings.

Struttura solida e design Made in Italy, le nostre sedute Iris sono costruite per durare. Grazie alla scocca iniettata in tecnopolimero ad alta resistenza e al sistema di iniezione brevettato delle nostre gambe in metallo-polimero, siamo in grado di fornire una collezione solida ed estetica. Iris garantisce un'ottima resistenza agli agenti atmosferici, alla nebbia salina, ai funghi, agli insetti, anche in condizioni estreme. Fornisce inoltre una resistenza eccezionale agli stress ambientali: una soluzione perfetta per aree ad alto traffico sia interne che esterne.



# Lilà

Studio Eurolinea Design

A system of multifunctional chairs and stools which express simplicity, linearity and lightness. Shells in plywood with different finishes make the collection easy to use in residential and community areas. Generously-sized ergonomic shapes are embellished by feature stitchwork in the regenerated leather upholstered version, available in 8 different colors.

E' un sistema di sedute e sgabelli multifunzionale che esprime semplicità, linearità e leggerezza. Le scocche in legno multistrato curvato nelle varie finiture disponibili rendono la collezione un facile complemento d'arredo per l'uso domestico e la collettività. Le ampie dimensioni e la forma ergonomica, vengono impreziosite dalle cuciture a vista nella versione rivestita in pelle rigenerata, disponibile in 8 differenti colori.

# Roller

Studio Eurolinea Design

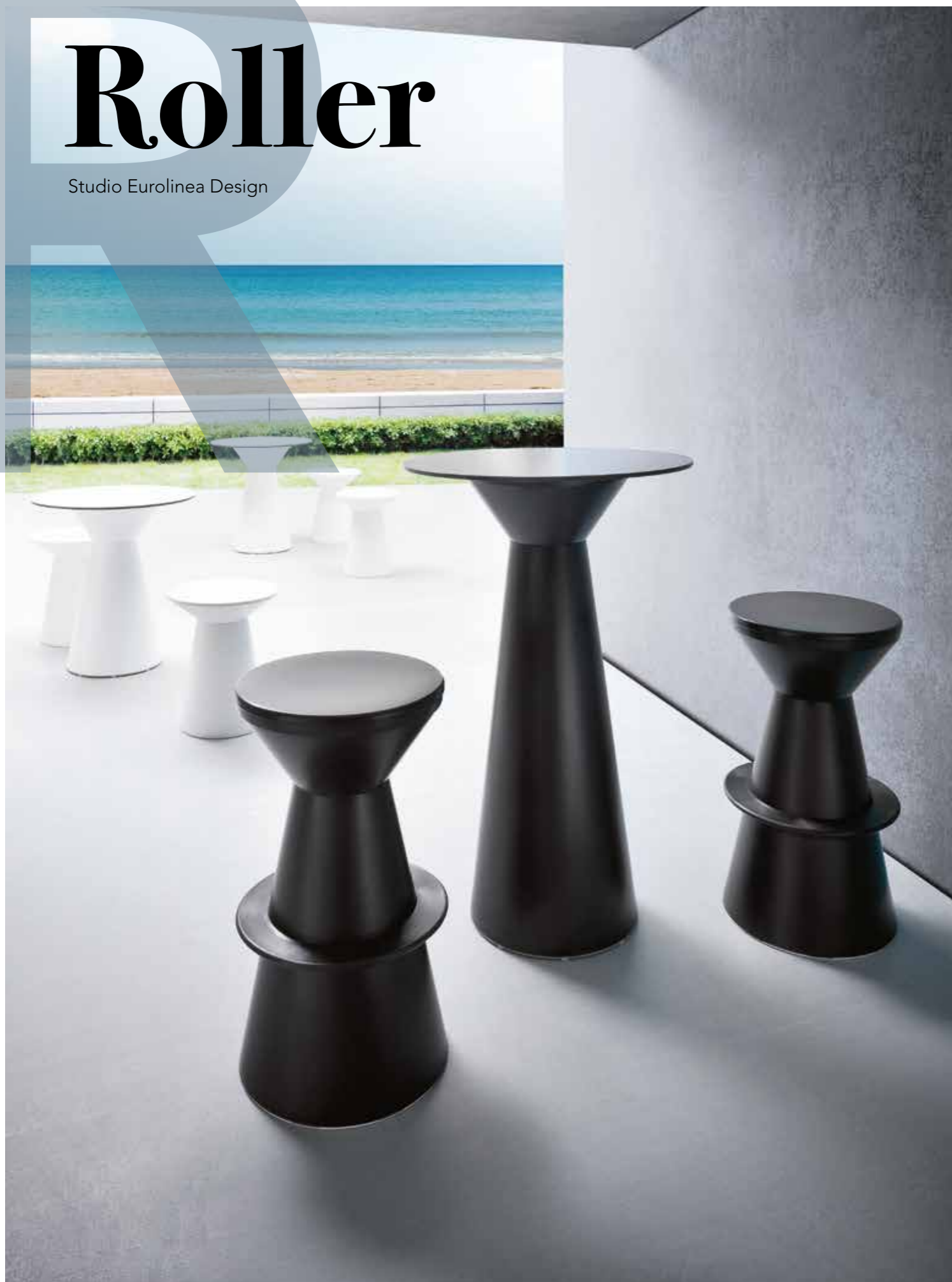

The playful shapes created by the Roller family of stools and tables make indoor and outdoor environments more fun and complete. The different heights and finishes help Interior designers in their search for the most suitable product. The development of the Roller family through injected techno-polymers makes the product smooth, easy to clean, and suitable for intensive use.

Il gioco di volumi creato dalla famiglia di sgabelli e tavoli Roller rende gli ambienti indoor ed outdoor più piacevoli e completi. Le diverse altezze e finiture aiutano l'Interior designer nel ricercare il prodotto più adeguato. La realizzazione della famiglia Roller per mezzo di iniezione di tecnopolimeri, rende il prodotto liscio, semplicemente pulibile, adatto ad un utilizzo anche intensivo.



# Format

Studio Eurolinea Design



The Format collection combines a strong metal frame and Compactop surfaces, creating a wide range of tables and benches.

La collezione Format unisce solide strutture in metallo a superfici in Compactop, creando una vasta gamma di tavoli e panche.

# Shiver

Studio Eurolinea Design



Shiver is a stool made entirely of techno-polymer, fully recyclable. Ideal for outdoor use, thanks to the rigorous design and the wide choice of available colors, fit perfectly any habitat. Shiver is stackable, lightweight, functional and durable.

Shiver è uno sgabello realizzato integralmente in tecnopolimero, completamente riciclabile. Ideale per l'uso outdoor, grazie al design rigoroso e alla vasta scelta di colori disponibili, si integra perfettamente ad ogni habitat. Shiver è impilabile, leggero, funzionale e robusto.

# Octo

Stefano Sandonà Design



GOOD DESIGN AWARD 2012  
OF CHICAGO ATHENAEUM : MUSEUM OF ARCHITECTURE AND DESIGN  
product design award 2013

The mystic number eight and the symbol of infinity have inspired this designer stool, with an essential and continuous shape, capable of revolutionizing the look of any interior. Swivel seat is standard. Optionally with gaslift, the height adjustment button nesting within the seat.

Il mistico numero otto e il simbolo dell'infinito hanno ispirato questo sgabello dalla forma essenziale e continua, capace di rinnovare l'estetica di ogni tipo di spazio. Disponibile nella versione girevole fissa e girevole con regolazione di altezza, nasconde il pulsante di regolazione integrato nella scocca.

# Freedom

Stefano Sandonà Design



interior innovation award 2011  
WINNER  
FX  
DESIGN AWARD  
WINNER  
Innovation Deutschland 2012  
WINNER

A pure expression of velocity and high technical performance, Freedom is a futuristic designer stool, with sharp, flowing lines. In twin-color techno-polymer, this barstool has a swivel seat with optional height adjustment. The various color combinations make Freedom suitable for any environment.

Espressione pura di velocità e di elevate performance tecniche, Freedom è uno sgabello dal design avveniristico, dalle linee fluide e taglienti. Realizzato in tecnopolimero bicolore, lo sgabello è disponibile con base cromata, girevole o girevole e regolabile in altezza. Le varie combinazioni cromatiche disponibili lo rendono adatto a qualsiasi ambiente.

# Pop

Stefano Sandonà Design

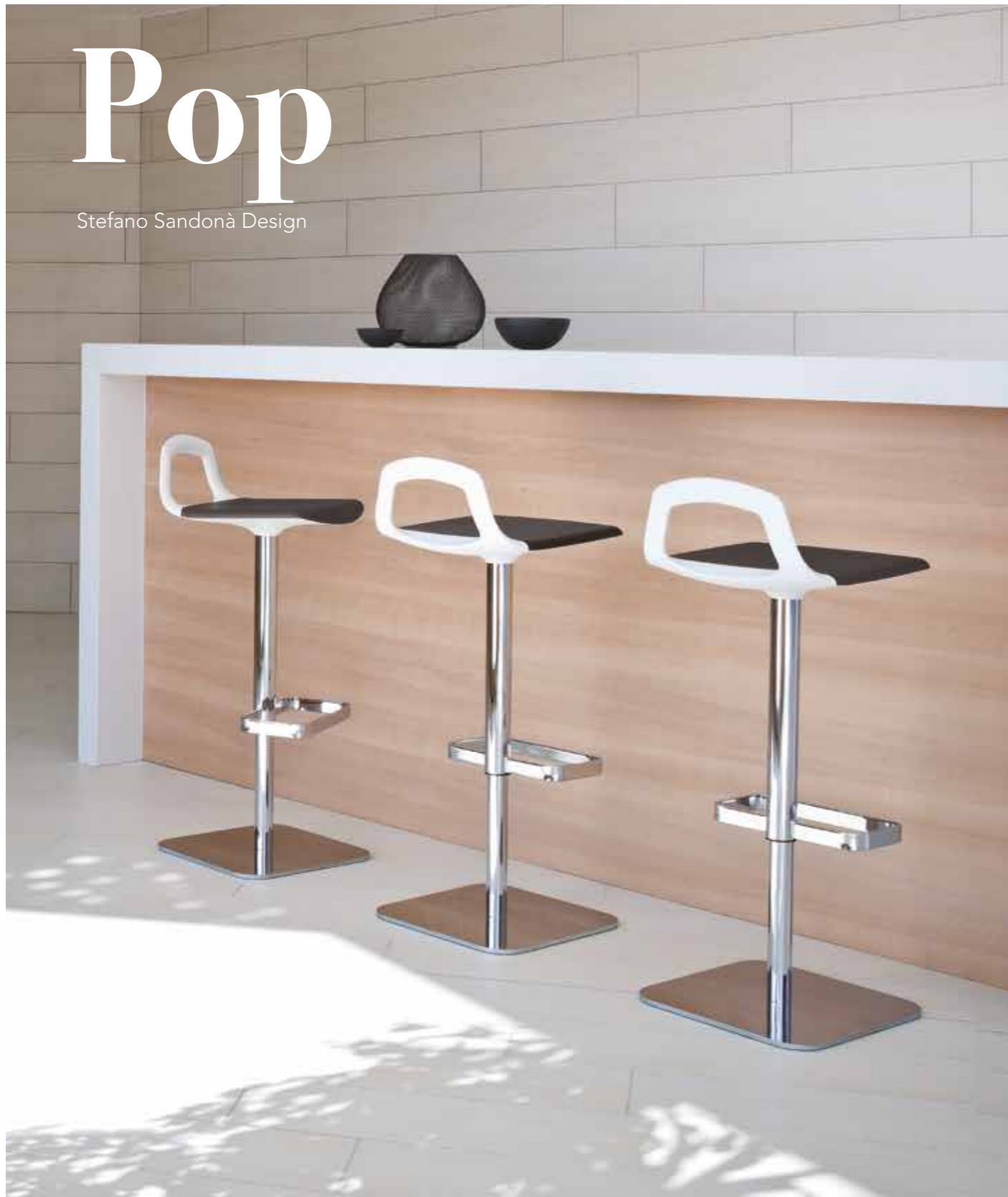

Twin-color, height adjustable, equipped with a practical handle integrated into the techno-polymer structure, the Pop stool features technical excellence and attractive design. The comfortable seat is available in the practical techno-polymer version, or padded and upholstered in faux leather.

Bi-colore, regolabile in altezza, dotato di una pratica maniglia integrata nella struttura in tecnopolimero, lo sgabello Pop è un prodotto di alta qualità tecnica e dal piacevole design. La confortevole seduta è disponibile nella pratica versione in tecnopolimero o imbottita e tappezzata in ecopelle.

# Guliver-Free

Studio Eurolinea Design

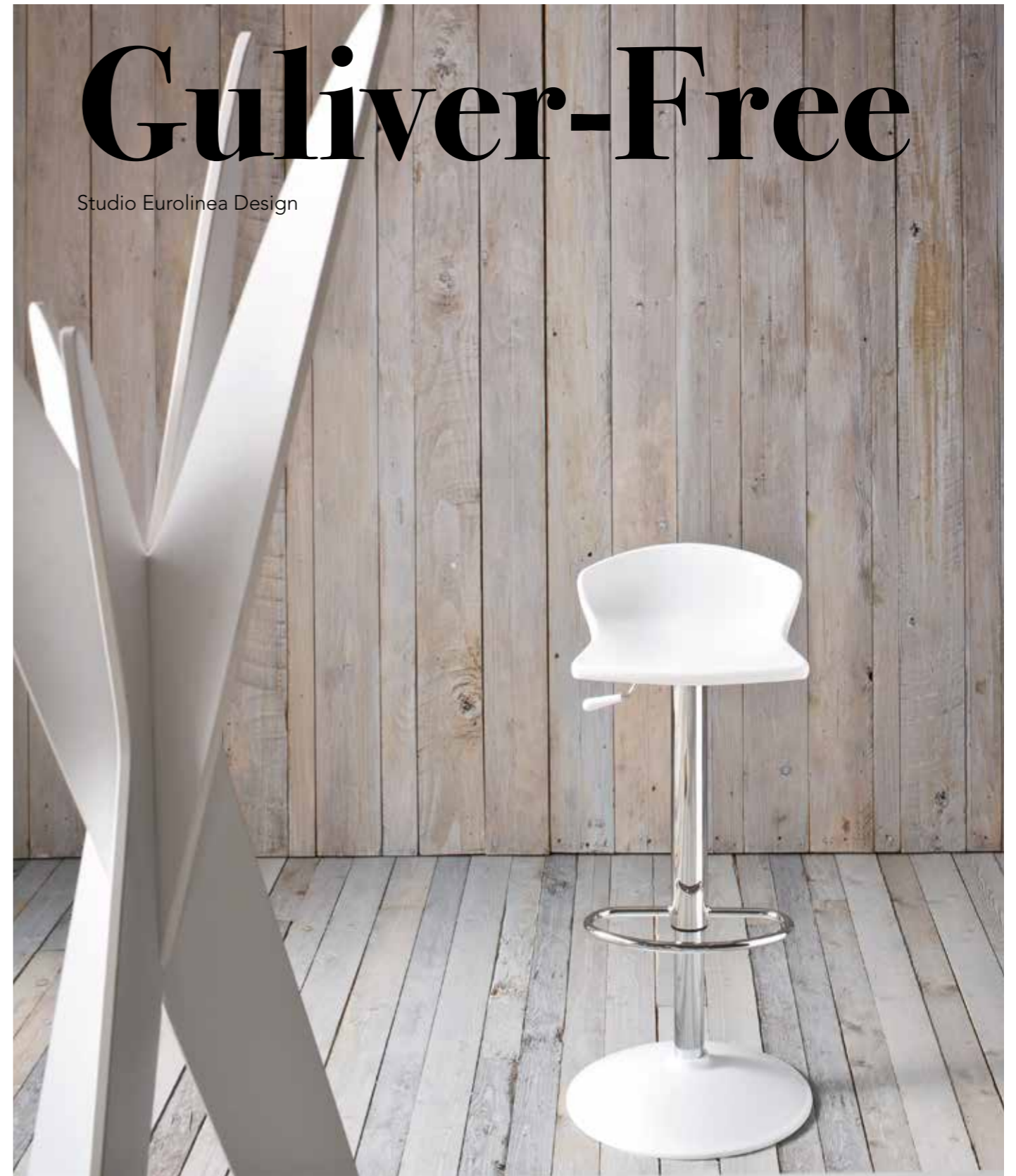

The Guliver and Free stool collection is characterized by an ergonomic and compactly sized seat, ideal for high density arrangements. Both stools can have a choice of bases: chromed metal; or metal co-injected with techno-polymer, in the same color as the seat. Guliver and Free have swivel seats; Guliver is also height adjustable.

La collezione di sgabelli Guliver e Free si caratterizza per una seduta ergonomica dalle dimensioni ridotte, adatta anche a disposizioni ad alta densità. Entrambi gli sgabelli possono utilizzare basamenti cromati o in metallo co-iniettato con tecnopolimero, nella stessa tonalità delle sedute. Lo sgabello Guliver si distingue in quanto girevole e regolabile in altezza; lo sgabello Free è disponibile nella sola versione girevole.



# Swing

Stefano Sandonà Design

An attractive and asymmetrical design stool, an icon of elegant practicality, Swing has a glossy techno-polymer seat. Swivel and height-adjustable, it fits perfectly into its surroundings, immediately taking centre stage.

Sgabello dal design accattivante ed asimmetrico, icona di elegante praticità, dispone di una seduta in tecnopolimero con finitura lucida. Girevole e regolabile in altezza, si adatta perfettamente all'ambiente che lo circonda, diventando da subito protagonista.



# Torino

Stefano Sandonà Design

The asymmetrical design is embellished with skillfully executed padding and leather upholstery, handcrafted, with visible stitchwork. Torino stool takes shape thanks to this high-level craftsmanship, made to complete residential furnishings or the most prestigious contract projects.

Il design asimmetrico viene anche impreziosito da imbottitura e tappezzeria in pelle, realizzata artigianalmente, con impuntura a vista. Prende forma così lo sgabello Torino, realizzato per completare gli arredamenti residenziali o per i progetti contract più prestigiosi.



# Micro

Studio Eurolinea Design

The Micro stool collection fits simply into any setting, from residential to the most demanding hospitality environment. Micro is both swivel and adjustable height.

La collezione di sgabelli Micro si adatta semplicemente ad ogni ambiente, dall'utilizzo residenziale alle più esigenti richieste dell'ospitalità. Lo sgabello Micro si distingue in quanto girevole e regolabile in altezza.



# Asole

Studio Eurolinea Design

The Asole stool was designed with an eye to detail: all parts are precisely developed for optimum performance according to function. The technopolymer shell, skilfully covered with leather, maintains the same thickness as the standard version, highlighting its design with feature side stitchwork.

Lo sgabello Asole è stato realizzato con un occhio per i dettagli: tutte le singole parti sono sviluppate per svolgere in maniera ottimale la propria funzione, sia tecnica che estetica. La scocca in tecnopolimero, rivestita artigianalmente in cuoio, mantiene uno spessore contenuto come nella versione standard, arricchendo il design con cuciture laterali a vista.

# Over - Square

Studio Eurolinea Design



This collection of stools is characterized by a simple and linear seat, combined with a series of different basements: metal chromed finishes or metal-techno-polymer co-injected bases, in the same color of the seat. Over stands out as swivel and adjustable in height stool; Square is available only swiveling.

Questa collezione di sgabelli è caratterizzata da una seduta semplice e lineare, abbinata ad una serie di strutture con basamenti in metallo cromati, oppure in tinta con la seduta stessa realizzati per mezzo di co-iniezione metallo-tecnopolimero. Lo sgabello Over si distingue in quanto girevole e regolabile in altezza; lo sgabello Square è disponibile nella sola versione girevole.

# Snack - Citro

Studio Eurolinea Design

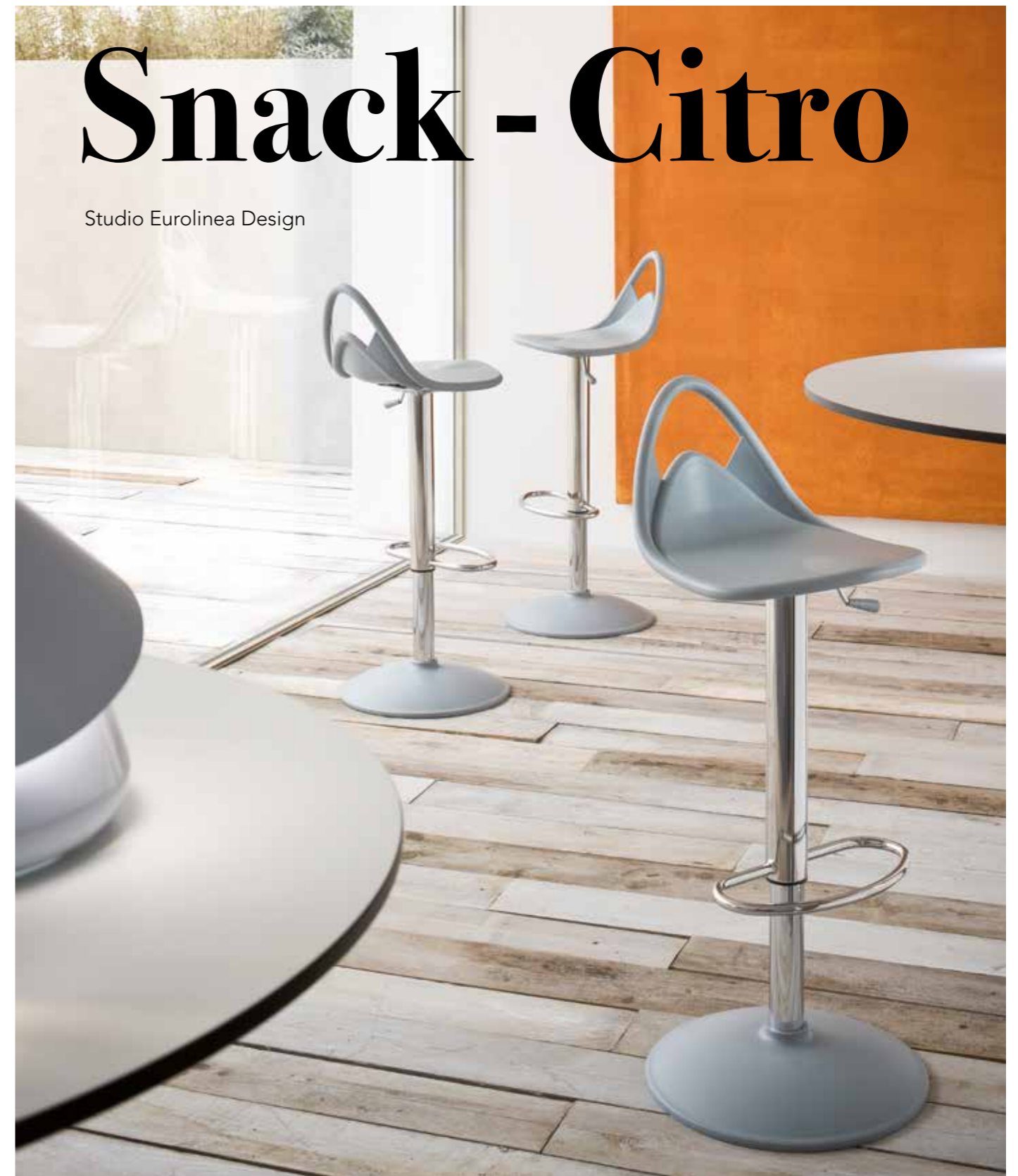

The Snack and Citro collection is characterized by the sharp design of the practical back support and for the color combination between the seat and the co-injected techno-polymer-metal base. Sturdy and reliable, the stools can be swivel and height adjustable (Citro) or only in swivel version (Snack): both with the possibility of using co-injected techno-polymer or chromed bases.

La collezione di sgabelli Snack e Citro si contraddistingue per il marcato design del pratico schienale di supporto e per l'abbinamento cromatico tra i colori della seduta e del basamento co-iniettato tecnopolimero-metallo. Robusti e affidabili, gli sgabelli possono essere girevoli e regolabili in altezza (Citro) o nella sola versione girevole (Snack): entrambi con la possibilità di utilizzare basamenti cromati o rivestiti in tecnopolimero.



# Tom - Joy - Fix

Studio Eurolinea Design



This sturdy collection of stools, easy to use, is distinguished by a practical seat with an integrated handle. Stools are available with metal-techno-polymer co-injected bases or with chromed bases, swiveling (Fix and Joy) or even height-adjustable (Tom). The techno-polymer co-injected base is available in the same color of the seat, creating a nice color effect.

Questa collezione di sgabelli robusti e di facile uso, si distingue grazie ad una seduta con pratica maniglia integrata. Gli sgabelli, disponibili con base in metallo-tecnopolimero co-iniettato o con basamenti cromati, sono girevoli (Fix e Joy) o anche regolabili in altezza (Tom). Il basamento rivestito in tecnopolimero è disponibile nella stessa tonalità della seduta, creando un piacevole effetto cromatico.

# Easy

Studio Eurolinea Design

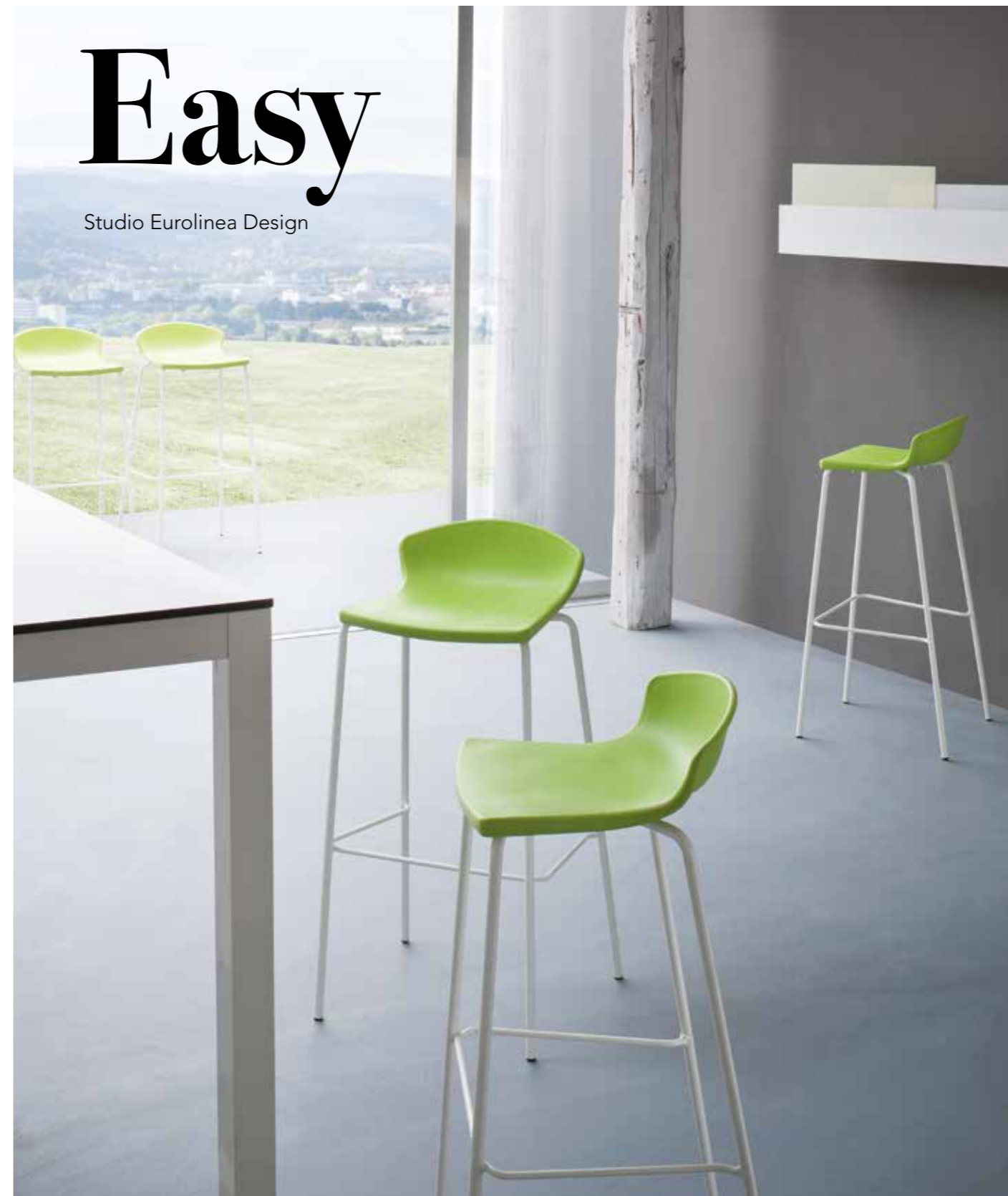

Easy is an ergonomic and stackable stool, light and sturdy, with simple and elegant design. Available with four legs metal structures, in two different heights, chromed or painted for outdoor purposes. The wide range of bright colors makes Easy suitable for any environment.

Easy è uno sgabello ergonomico ed impilabile, dal design semplice e raffinato. Easy è leggero e robusto, con strutture a quattro gambe in due altezze, cromate o verniciate per esterno. Le vasta gamma di colori vivaci rende Easy adatto ad ogni ambiente.

# Cross

Studio Eurolinea Design



Cross stools are available on four legs metal chromed frames. The padded and upholstered seat is enhanced with feature stitchwork, made in faux leather. Its playful shape and excellent comfort are the most appreciated features of this original object.

Gli sgabelli Cross sono disponibili con telai cromati a quattro gambe, dalle forme sinuose. La seduta imbottita e tappezzata in ecopelle è arricchita dalla cucitura di fattura artigianale. La sua forma gioiosa e il confort eccellente sono le caratteristiche più apprezzate di questo oggetto originale.

# Jimmy

Studio Eurolinea Design



Jimmy is a stool with a practical back support and a chromed sinuous frame. The integrated handle in the backrest, which distinguishes the design, it is useful for an easy transportability. The wide range of colors available makes it suitable for any habitat.

Jimmy è uno sgabello dotato di un pratico schienale di supporto e da una struttura cromata dalle forme sinuose. La maniglia integrata nello schienale, che ne distingue il design, è utile per una semplice trasportabilità. La vasta scelta nei colori disponibili lo rende adatto a qualsiasi habitat.

# Ofer

Studio Eurolinea Design



The Ofer stool collection, thanks to the integrated handle on the seat, fits simply into any setting, from residential to the most demanding outdoor environment. Stool bases are in two different sizes; seat and footrest are techno-polymer made, legs are made of anodized aluminum.

La collezione di sgabelli Ofer, grazie alla maniglia integrata nella seduta, si adatta perfettamente ad ogni ambiente, dal residenziale al più esigente ambiente esterno. La base degli sgabelli è disponibile in due altezze; la seduta e il poggiatesta sono realizzati in tecnopolimero ad alta resistenza, le gambe sono realizzate in alluminio anodizzato.

# Flaire

Studio Eurolinea Design



Techno-polymer Lamp collection with diffused shine effect.

Collezione di lampade in materiale plastico con effetto a bagliore diffuso.

# Lux

Studio Eurolinea Design



Anodized aluminum  
and techno-polymer coat-hanger.

Appendiabiti in alluminio  
anodizzato e tecnopolimero

## COLOURS AND COVERINGS COLORI E RIVESTIMENTI

Techno-polymer / Tecnopolimero

05 Light blue / Azzurro	99 Lavender / Lavanda	98 Pale blue / Avio	34 Light blue / Azzurro	08 Blue / Blu	09 Dark Blue / Blu scuro	16 Indigo / Indaco	11 Night Blue / Blu notte
03 Light green / Verdino	42 Green / Verde	51 Sage green / Salvia	35 Lime / Lime	41 Green / Verde	25 Olive Green Verde Oliva	23 Military green Verde militare	24 Forest green Verde foresta
36 Mustard / Senape	02 Yellow / Giallo	38 Saffron / Zafferano	07 Apricot / Albicocca	33 Orange / Arancione	20 Lobster / Aragosta	06 Red / Rosso	12 Brick / Mattone
26 Marsala / Marsala	22 Bordeaux / Bordeaux	01 Beige / Beige	54 Sand / Sabbia	18 Dusty Rose Polvere Rosa	13 Brown / Marrone	52 Turtledove / Tortora	55 Mineral Grey Grigio Minerale
39 Brown / Marrone	00 White / Bianco	14 Pearl grey / Grigio perla	04 Grey / Grigio	21 Grey / Grigio	10 Black / Nero		

44 Transparent Trasparente	45 Transp. red Rosso trasp.

# COLOURS AND COVERINGS COLORI E RIVESTIMENTI

## K King Fabric / Tessuto King

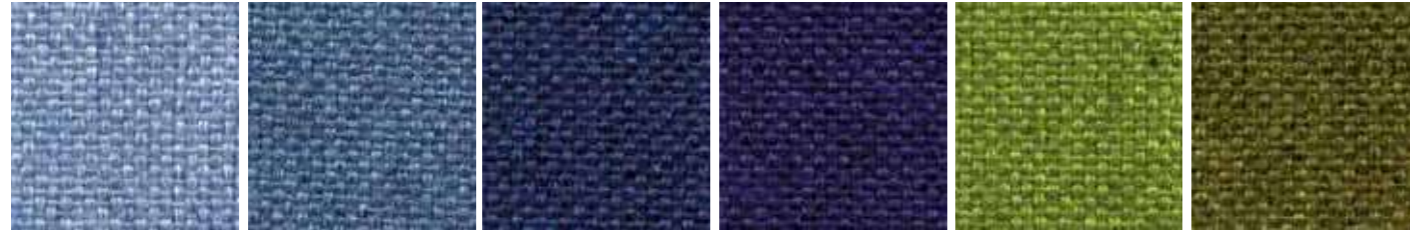

6001 6091 6034 6052 7019 7022



3030 3082 4021 4032 5001

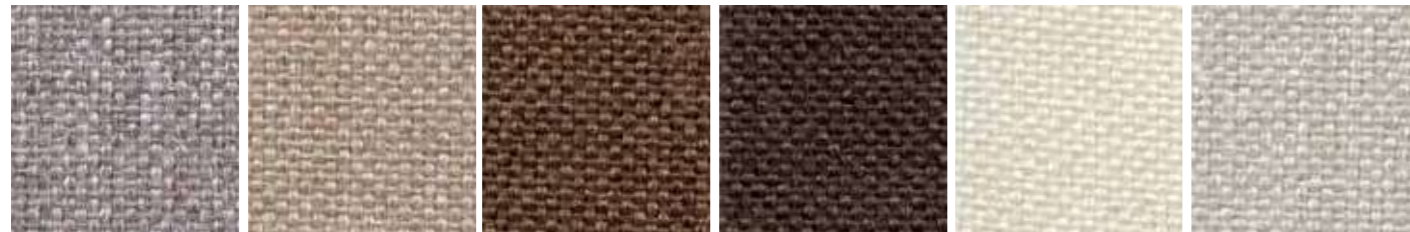

1033 1008 2003 2007 1012 1025

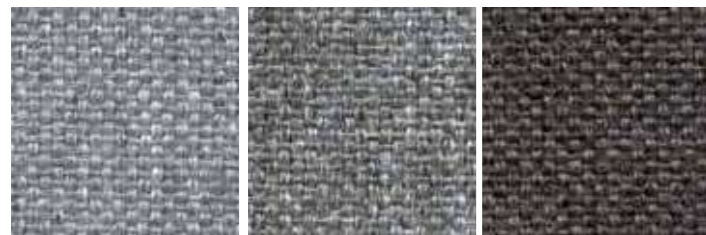

8032 8006 8011

- Composition: 100% POLYESTER - TREVIRA CS
- Abrasion: UNI EN ISO 12947-2 80.000 Cycle Martindale  $\pm 10\%$
- Light Resistance-Xenotest: UNI EN ISO 105-B02 / 6 (tol from 5 to 8)
- Fire proof: UNI 9174 - 8456 Class C1, UNI 9175 Class 1, DIN 4102 Class B1, NF 92501-7 Class M1, NF D 60013 Class AM18, EN 1021-1 & 2, BS Crib 5, BS 7176 Class Medium Hazard, EN 13773 Class 1, OENORM 3800-1 Class B1,Q1,TR1, California TB117, USA NFPA 701, USA NFPA 260, IMO A 652 (16) Part 8 Upholstery
- Maintenance: Standard 60° C cotton cycle.

Visit [www.fidivi.com](http://www.fidivi.com) for complete colours range / Visionate la completa gamma colori su [www.fidivi.com](http://www.fidivi.com)

## L King L Fabric / Tessuto King L

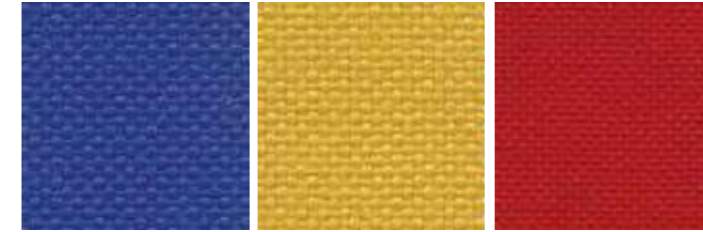

6071 3090 4027

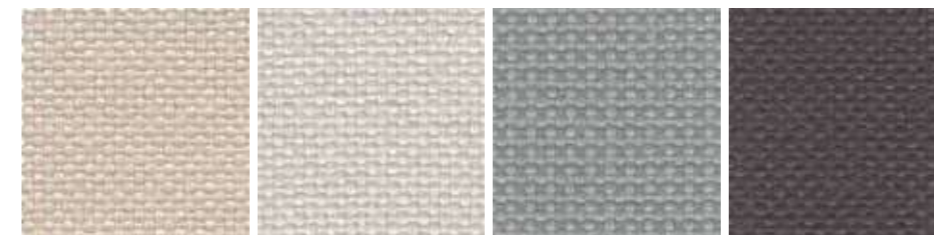

1010 1025 8014 8010

- Composition: 100% POLYESTER
- Abrasion: UNI EN ISO 12947/2 70.000 Cycle Martindale  $\pm 10\%$
- Light Resistance-Xenotest: UNI EN ISO 105-B02 / 6 (tol from 5 to 8)
- Fire proof: UNI 9174 - 8456 Class C1, DIN 4102 Class B1, NF P 92501-7 Class M1, IMO Res. A652 (16), NF D 60013 Class AM18, EN 1021-1 & 2, BS 5852 part II Crib 5, BS 7176 Medium Hazard, ONORM B 3825-Onorm A 3800-1 Class B1-Q1-TR1
- Maintenance: Use vacuum-cleaner, don't brush.

Visit [www.fidivi.com](http://www.fidivi.com) for complete colours range / Visionate la completa gamma colori su [www.fidivi.com](http://www.fidivi.com)

# COLOURS AND COVERINGS COLORI E RIVESTIMENTI

## DK Kvadrat Fabric (Steelcut2) / Tessuto Kvadrat (Steelcut2)

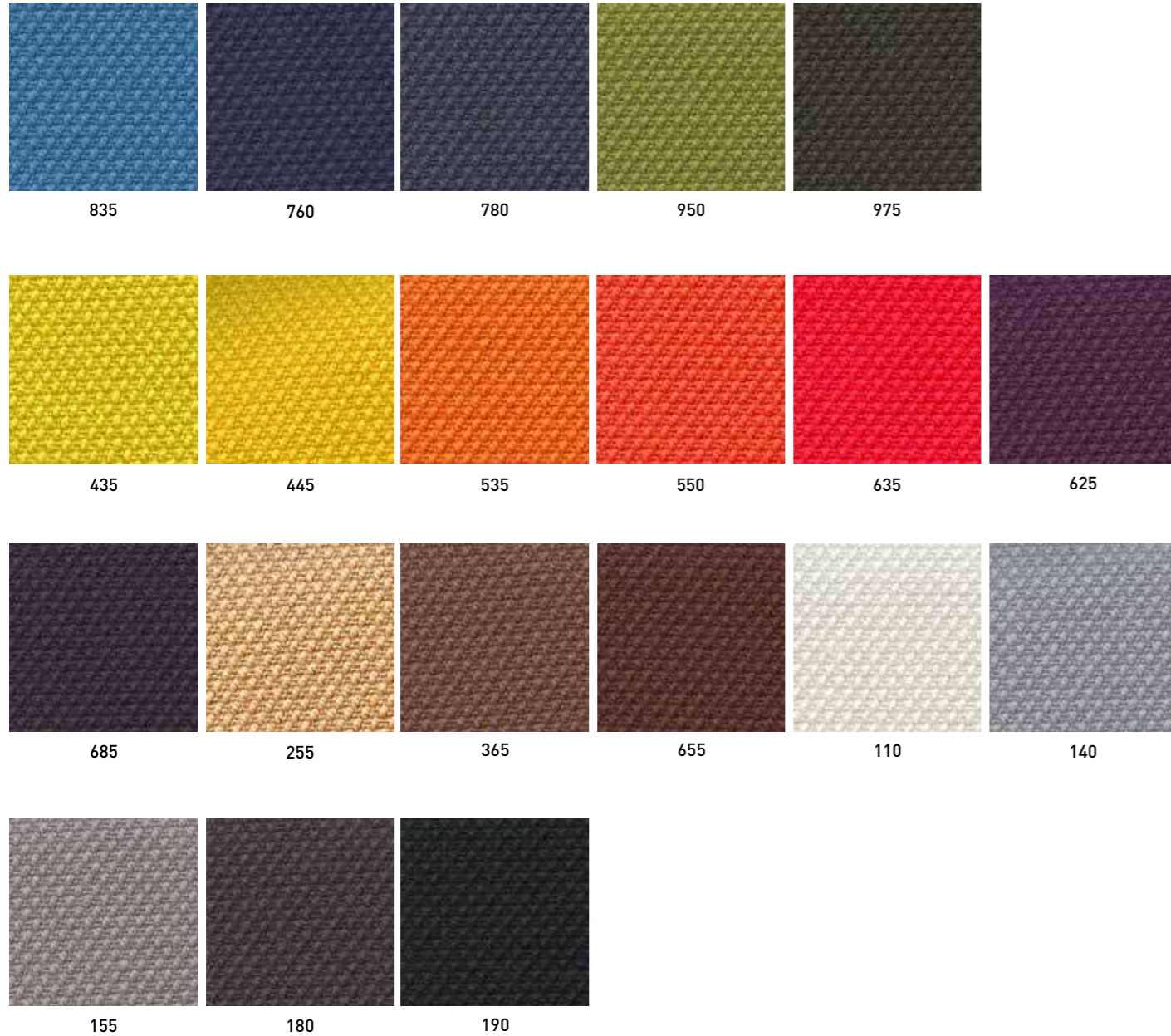

- Composition: 90% New wool worsted - 10% Nylon
- Abrasion: Approximately 80.000 Martindale rubs, EN ISO 12947
- Lightfastness: Note 5-7, ISO 105-B02
- Fire proof: AS/NZS 3837, class 2, BS 5852 Crib 5 with treatment, BS 5852 part 1, DIN 4102 B2, EN 1021-1/2, IMO FTP Code 2010 Part 8, NF D 60 013, ÖNORM B1/ Q1, UNI 9175 11M, US Cal. Bull. 117-2013, NFPA 260, AS/NZS 1530.3, SN 198 898 5.3 with treatment

Visit [www.kvadrat.dk](http://www.kvadrat.dk) for complete colours range / Visionate la completa gamma colori su [www.kvadrat.dk](http://www.kvadrat.dk)

## DK Kvadrat Fabric (Remix2) / Tessuto Kvadrat (Remix2)

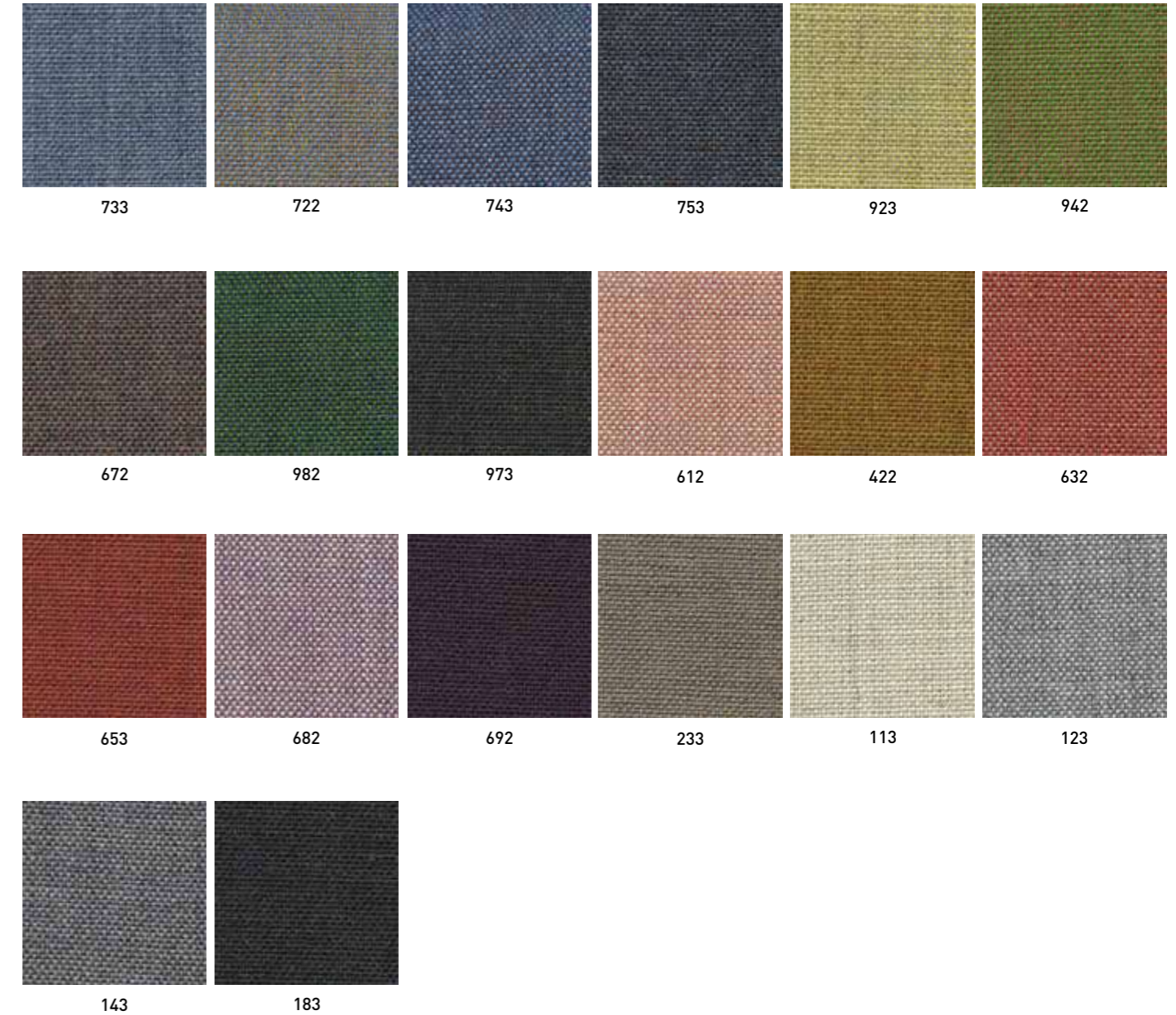

- Composition: 90% wool, 10% nylon
- Abrasion: Approximately 100.000 Martindale rubs, EN ISO 12947
- Lightfastness: Note 5-7, ISO 105-B02
- Fire proof: EN 1021-1/2, BS 5852 part 1, Önorm B1/Q1, NF D 60 013, UNI 9175 11M, AS/NZS 1530.3, US Cal. Bull. 117-2013, NFPA 260, IMO FTP Code 2010: Part 8, AS/NZS 3837, class 2, BS 5852 Crib 5 with treatment

Visit [www.kvadrat.dk](http://www.kvadrat.dk) for complete colours range / Visionate la completa gamma colori su [www.kvadrat.dk](http://www.kvadrat.dk)

# COLOURS AND COVERINGS COLORI E RIVESTIMENTI

## DK Kvadrat Fabric (Umami) / Tessuto Kvadrat (Umami)

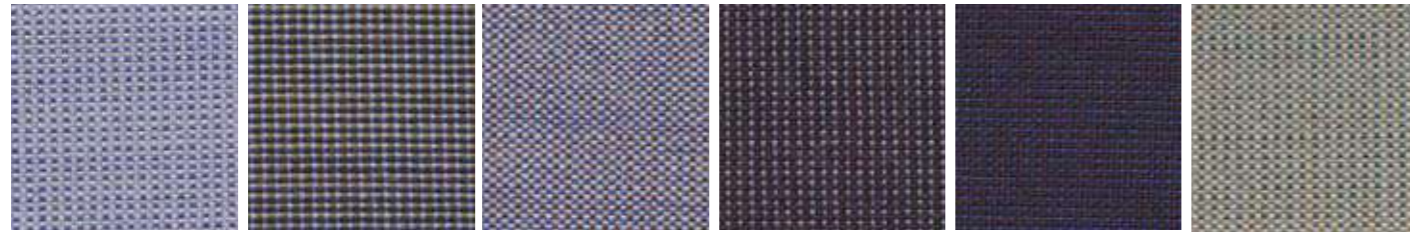

711 721 731 651 761 231



851 611 441 551 661 871



221 621 251 471 111 191



181

- Composition: 90% wool, 10% nylon
- Abrasion: Approximately 80.000 Martindale rubs, EN ISO 12947
- Lightfastness: Note 6-7, ISO 105-B02
- Fire proof: EN 1021-1/2, BS 5852 part 1, NF D 60 013  
UNI 9175 11M, US Cal. BuLL 117-2013, IMO A.652 (16)  
AS/NZS 3837, class 2, IMO FTP Code 2010 Part 8, BS 5852 Crib 5 with treatment

Visit [www.kvadrat.dk](http://www.kvadrat.dk) for complete colours range / Visionate la completa gamma colori su [www.kvadrat.dk](http://www.kvadrat.dk)

## B Blazer Fabric / Tessuto Blazer



CUZZZ CUZ1E CUZ86 CUZ47 CUZ1T CUZ2R



CUZ3D CUZ18 CUZ63 CUZ82 CUZ1N CUZ1K



CUZ2X CUZ62 CUZ1W CUZ67

- Composition: 100% VIRGIN WOOL
- Abrasion: BS EN ISO 12497-2 65.000 Cycle Martindale
- Light Resistance-Xenotest: UNI EN ISO 105-B02 / 5
- Fire proof: BS EN 1021 Part 1, BS EN 1021 Part 2, BS 7176 Low Hazard,  
BS EN 13501-1:2007 Class D, NF D 60-013 AM18, UNI 9175:2010 Class 11M, BS476 part 7 Class 1, ONORM B 3825
- Maintenance: Use the vacuum-cleaner.

Visit [www.camirafabrics.com](http://www.camirafabrics.com) for complete colours range / Visionate la completa gamma colori su [www.camirafabrics.com](http://www.camirafabrics.com)

# COLOURS AND COVERINGS COLORI E RIVESTIMENTI

## TF Fenice Fabric / Tessuto Fenice



351 451 101 201 505 551

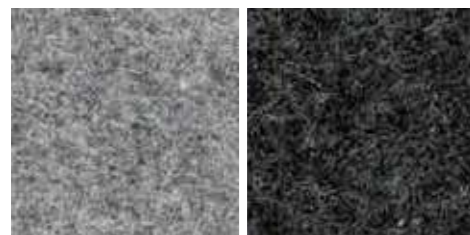

601 603

- Composition: 75% WOOL - 25% POLYAMMIDE
- Abrasion: UNI EN ISO 12497:2000 100.000 Cycle Martindale  $\pm 20\%$
- Light Resistance-Xenotest: UNI EN ISO 105-B02 / 4 (tol from 3 to 5)
- Fire proof: IT - CLASSE 1 IM Using a standard FR polyurethane foam 25kg/mcu density, CAL 117-2013 EN-1021 Part 1-2 using a standard foam 20/22 Kg/mcu density
- Maintenance: Use vacuum-cleaner, don't brush.

Visit [www.pugirg.it](http://www.pugirg.it) for complete colours range / Visionate la completa gamma colori su [www.pugirg.it](http://www.pugirg.it)

## M Miki Fabric / Tessuto Miki



6445 6490 6713 6432 6334 NERO

- Composition: Composizione 100% PL 65/75 g/m<sup>2</sup> - Composition 100% PL 65/75 g/m<sup>2</sup>
- Light Resistance-Xenotest: UNI EN ISO 105-B02 / 01
- Maintenance: Dust with a soft and dry cloth.

## TX Textsilk Fabric / Tessuto Textsilk

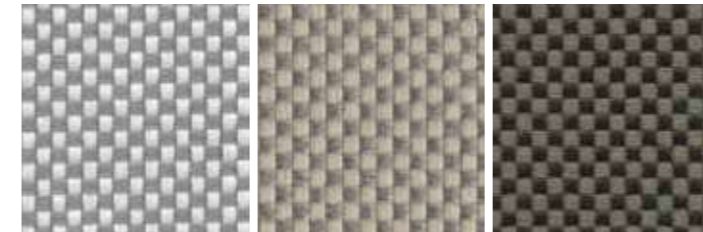

S-3 S-4 S-6

- Composition: 100% Olefin
- Finish: Teflon® Water & oil repellent
- Color Fastness: Light Fastness UNI EN ISO 105-B02:2001 - 8 (max 8), Fastness to rubbing UNI EN ISO 105-X12:1996 - 4-5 (max 5), Swimming Pool water fastness UNI EN ISO 105-E03:1997 - 5 (max 5)
- Physical Characteristics: Breaking Streight UNI EN ISO 13934-1 - Warp 1877N - Weft 980N, Tear resistance UNI EN ISO 13937-3 - 81,4 N - 54,2 N, Abrasion Resistance UNI EN ISO 12947 (part 1 & 2) - 20.000 cycles, Pilling resistance UNI EN ISO 12945-2 - 5 (max 5), Dimensional Change in washing UNI EN 25077:1996 -0,4% -0,3%, Spray test UNI EN 24920 - 5 (max 5)

Visit [www.etisilk.com](http://www.etisilk.com) for complete colours range / Visionate la completa gamma colori su [www.etisilk.com](http://www.etisilk.com)

## GR Progarden Fabric / Tessuto Progarden

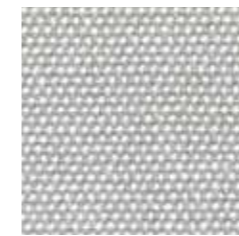

012 LINEN

- Composition: 100% yarn dyed acrylic
- Martindale (ISO 12947-2): 15.000 cycles
- Dimensional change after washing at 40°C and drying (warp/weft) (ISO 5077):  $\pm 2\%/0\%$
- Breaking strength (warp/weft) (ISO 13934-1): 200/70 daN
- Elongation at break (warp/weft) (ISO 13934-1): 25%/25%
- Tear strength (warp/weft) (ISO 13937-1): 7/3,7 daN
- Resistance to seam (warp/weft) (ISO 13935-1): 50/50 daN
- Air permeability (ISO 9237): 65 l/m<sup>2</sup>/s
- Finishing: Water repellent Teflon/Scotchgard treatment, dirt repellent and anti-mould treatment
- Spray Test (ISO 4920): 4 out of 5
- UV Colour fastness (ISO 105 B02): 5/8 out of 8
- Colour fastness to weather (ISO 105 B04): 5/8 out of 8
- Colour fastness after washing at 40°C (ISO 105 C06): 5 out of 5



# COLOURS AND COVERINGS

## COLORI E RIVESTIMENTI

### V Vogue Fabric / Tessuto Vogue



0018      0015      0002      0009      0001      0031

- Composition: Vinyl / Urethane Topcoat
- Abrasion: 100.000 cycles Martindale (EN ISO 12947:1999 Part 2)
- Fire proof: EN 1021 Part 1 & 2, UNE 23.727-90 1R/M.2, NF P 92-503/M2, DIN 4102 B2, UNI 9175 (1987) / UNI 9175/FA1 (1994) Classe 1.IM (UNO I EMME), ÖNORM B 3825, Gruppe 1 - Schwerbrennbares Verhalten, ÖNORM A 3800 Teil 1, Qualmbildungsklasse Q1 - schwachqualmend IMO FTP 2010 Code MSC.307 (88) Part 8 3.1 & 3.2, FMVSS 302, FAR 25/853, (MED) Marine Equipment Directive (in its current valid version), ECE R118 (replaces Directive 95/28/CE), EN 71-2:2006+A1:2007 - Safety of toys - Part 2: Flammability, Light Resistance-Xenotest: UNI EN ISO 105-B02 / 01, Far 25/853

Visit [www.spradling.eu](http://www.spradling.eu) for complete colours range / Visionate la completa gamma colori su [www.spradling.eu](http://www.spradling.eu)

### R Mesh Fabric / Tessuto Rete

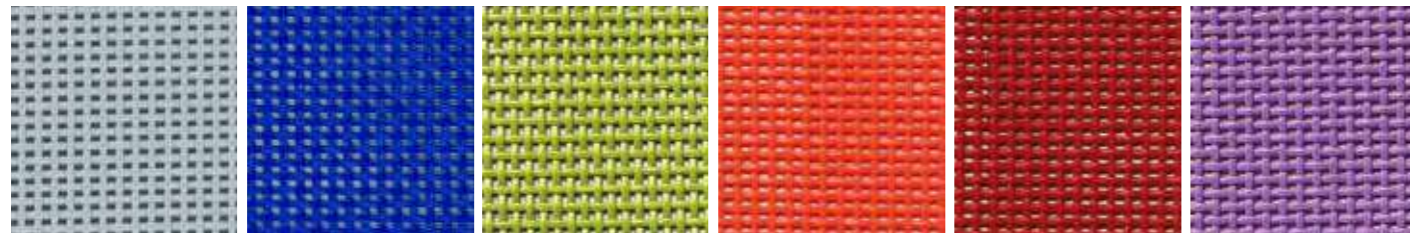

R08      R10      R07      R05      R04      R06



R09      R01      R03      R02

- Composition: Polyvinyl 70% - Polyester 30%
- Warp Tensile Strength: 310Kg/5cm
- Weft Tensile Strength: 270Kg/5cm
- Fire retardant on request

Visit [www.plastitex.com](http://www.plastitex.com) for complete colours range / Visionate la completa gamma colori su [www.plastitex.com](http://www.plastitex.com)

### MG Maglia Vinyl Fabric / Tessuto Maglia Vinile

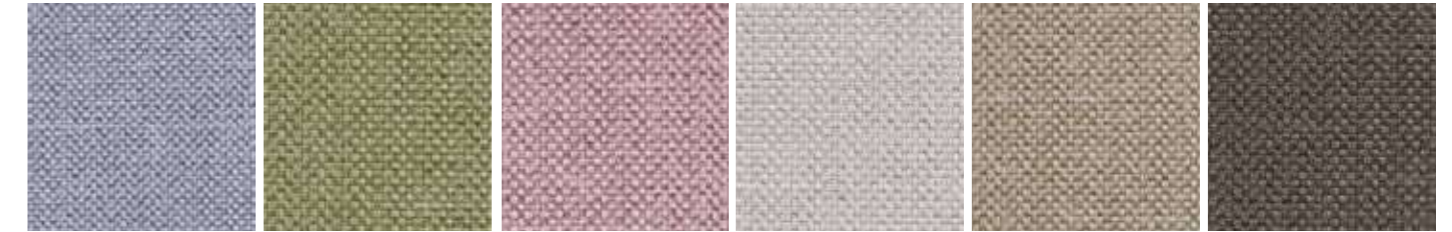

0003      0406      4203      5001      6025      4537

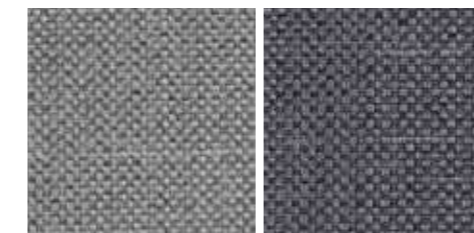

1702      6016

Visit [www.spradling.eu](http://www.spradling.eu) for complete colours range / Visionate la completa gamma colori su [www.spradling.eu](http://www.spradling.eu)

# COLOURS AND COVERINGS COLORI E RIVESTIMENTI

## E Simil leather Aurea / Ecopelle Aurea



23 7 14 15 16 8



9 10 17 19 21 11



2 3 5 6

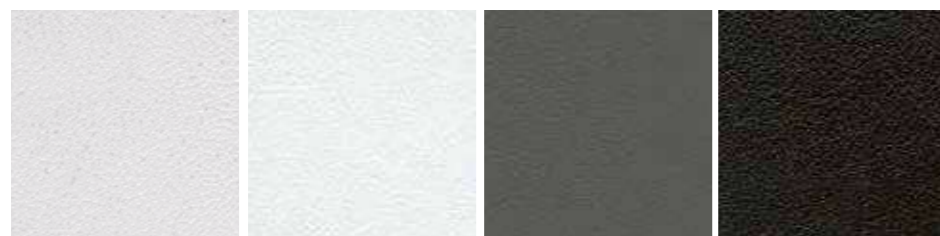

1 22 28 26

- Composition: 72% PVC - 3% PU - 25% COTTON
- Abrasion: EN ISO 5470-2 50.000 Cycle Martindale
- Light Resistance-Xenotest: UNI EN ISO 105-B02 / 6
- Fire proof: IMO resolution A.652 (16): 1989, BS 5852 CRIB 5, BS 5852-1 PART I, EN 1021-2, UNI 9175 CLASSE 1, TB 117 sez. E - p.1 (California)
- Maintenance: Dust gently or pass the surface with a damp cloth.

## C Leather / Cuoio



106 102 111 108 101 109

- Composition: 100% Grain Leather, Italian tannery
- Light Resistance: IUF/101
- Fire proof: CAL TB 117-00, Section E -part 1; BS 5852/90 section 4 (CRIB 5); UNI 91/75 Classe 2IM
- Maintenance: Dust gently or pass the surface with a damp cloth.

## P Leather / Pelle

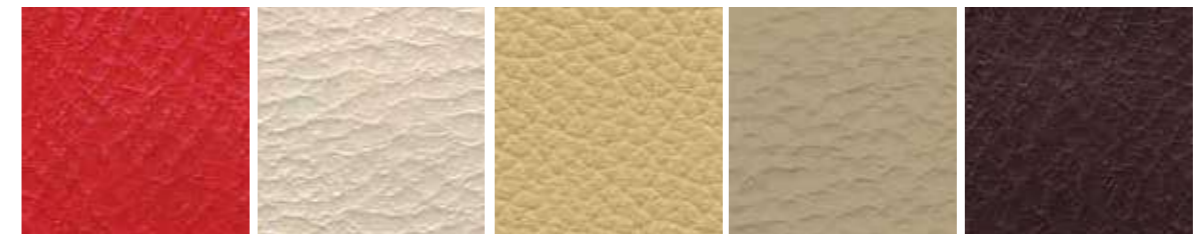

106P 102P 111P 110P 108P



101P 112P 109P

- Composition: 100% Top Grain Leather, Italian tannery
- Light Resistance-Xenotest: UNI EN ISO 105-B02 / 6
- Fire proof: BS EN 1021 Part 1, BS 1021 Part 2, BS 5852 Part 2 (with special fire-retardant padding)
- Maintenance: Dust with a soft and dry cloth.

Visit [www.flukso.it](http://www.flukso.it) for complete colours range / Visionate la completa gamma colori su [www.flukso.it](http://www.flukso.it)



# COLOURS AND COVERINGS COLORI E RIVESTIMENTI

## Bases and frames wooden finishes / Finiture legno basi e telai



OO White stained / Bianco



F Natural Beech / Faggio naturale



RN Natural Oak / Rovere Naturale



NC Walnut stained / Noce



W Wengé stained / Wengé

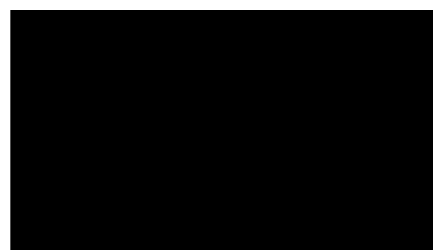

10 Black stained / Nero

F-W-B-N-NC finishes arise from Beech Essence. RN finish come from Oak Essence  
Le finiture F-W-B-N-NC derivano da essenza di Faggio. La finitura RN deriva da essenza di Rovere.

## Metal finishes / Finiture metalli

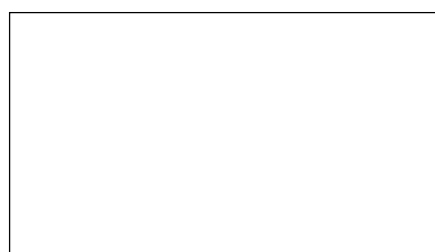

White / Bianco



Grey / Grigio

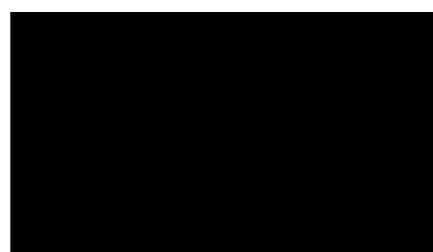

Black / Nero



Chromed / Cromato



Satin / Satinato

### GABER® LITERATURE

All Gaber® literature contains technical information and use-suggestions for those who intend to purchase or already have bought items from the Gaber® range. For Customers' interest, the Company may modify its products without any prior notice. Drawings, quoted materials and catalogue colors and price-lists are shown as a guide only and subject to tolerances. Dimensions are provided also in inches (") as a guide only. The colors displayed in Gaber® literature, related to techno-polymer finishing and coverings, fabrics, leather, lacquered or painted materials, wooden items, may change from time to time. Gaber® reserves the right to suspend the production of any of its products without any notice or reason. All rights of reproduction in whole or in part of Gaber® literature, related to text, images or illustration, or transmitted by any means, electronic or mechanical, including photocopying, recording or any information storage without written permission from Gaber®, are reserved worldwide.

### MATERIALS, USE AND MAINTENANCE

#### Plastic Materials

The Techno-polymer Compounds Gaber® uses on its products are characterized by high structural resistance, heat and abrasion resistance. Gaber® techno-polymers are non-toxic, stain resistant, antistatic and UV-resistant: thanks to all these features these materials have excellent resistance to atmospheric agents. All these materials are recyclable in the full respect of our Natural Environment. Gaber produces plastic injected materials without added chemicals and, as far as possible, recycled techno-polymers are sourced as a base raw material, recovered post-consumption.

Guidelines for correct usage: Do not expose plastic surfaces to direct heat sources. Plastic surfaces of Gaber® products usually need to be cleaned with a normal cloth and warm water. For the most persistent stains, a small amount of liquid soap diluted in water may be used. Strictly avoid the use of acetone, trichloroethylene, ammonia, alcoholic substances and detergents containing even a small amount of those substances. We also recommend avoiding all types of abrasive and solvent substances or rough sponges. Any liquid spilled on the product must be wiped up immediately. Even products made especially for outdoor purposes could be affected by atmospheric agents. Products may undergo exterior changes due to particular exposure to heat, humidity and salinity. Products may change color and shade if exposed to direct sunlight. An appropriate and frequent maintenance and cleaning of the products enhances its durability. Maintenance has to be carried out by experienced staff.

Gaber® glides and floorpads are made of blended rubber for heavy-duty use and are designed to minimise noise. Certain Gaber® items come ready-fitted with felt floorpads, specifically for hard or especially delicate floors.

Gaber® manufactures some bespoke products of its collection with fire retardant techno-polymer: the additives that make the fireproof plastic can substantially change the aesthetics and durability of the product.

#### Steel

High-resistance steel is used to produce frames for chairs, stools and tables by using square or round tubes as well as solid rod. Products are available in chrome or painted finishes. Special epoxy powder coating used on many Gaber® structures achieves excellent resistance to atmospheric agents.

#### Aluminum

Gaber® use aluminum to produce frames for chairs, stools and tables. Aluminum surfaces can be anodized, and Gaber® use this special treatment in order to increase resistance to corrosion.

Guidelines for correct usage: both steel and aluminum surfaces usually need to be cleaned with a normal cloth and warm water. For the most persistent stains, a small amount of mild liquid soap diluted in water may be used. Any liquid spilled on the product must be wiped up immediately. We recommend avoiding all types of abrasive creams or pastes, abrasive sponges, chlorine, bleach or strong detergents.

#### Wood

Our wooden products are produced in accordance with the European Regulations in force regarding formaldehyde emissions from wood-based products.

Guidelines for correct usage: Wooden products, being natural materials, can be damaged easily. Small impurities or imperfections are within quality standard range. Plywood surfaces need to be cleaned with a cloth and water. We recommend drying immediately after the cleaning process.

#### Flexible polyurethane padding

The flexible polyurethane cold-pressed paddings Gaber® uses on some of its upholstered products do not contain CFC/HCFC (ODP=0: do not contribute to the reduction of the atmospheric ozone layer), they are fire-retardant class 1-IM UNI 9175 / CMHR following European Standards.

#### Coverings: Fabrics and Leathers

Gaber® uses fabrics and leathers that belong to a wide range of colors and patterns, which are all tested in order to achieve the best performance, among which resistance to abrasion and artificial light. Fire-retardant fabrics and eco-leather upholstery are also available.

Guidelines for correct usage: Clean leathers with a soft cloth with water. Refer to technical specifications for fabric cleaning.

#### PACKAGING AND RECYCLING

Our packages are designed to optimize storage and transport requirements, they are made of 90% recycled raw material and are completely recyclable in themselves. The optimization of packaging in terms of volume and weight delivers a lower consumption of energy in many forms, helping the environment and a consequent saving on transport costs. In order to avoid the loss of components, packaging must be disposed only after completing the assembly of the products. Once the product has been dismantled, the product itself or its components must be given to public garbage system, according to local rules.

#### INNAPROPRIATE USES OF THE PRODUCT

Avoid any improper use of the product: do not step on the product, do not stand on footrest or on armrests, do not seat on the back or on armrest, do not use the chair as a ladder. The product should not be subjected to swinging back and forwards that may damage the furniture or result in injury to the user. When lifting or moving the product, hold it by the main structure and not just under the seat. Gaber® will accept no liability for any damages caused to property or persons subsequent to incorrect or improper handling of the product. Gaber® also declines any responsibility in cases of damage caused to fragile floors.





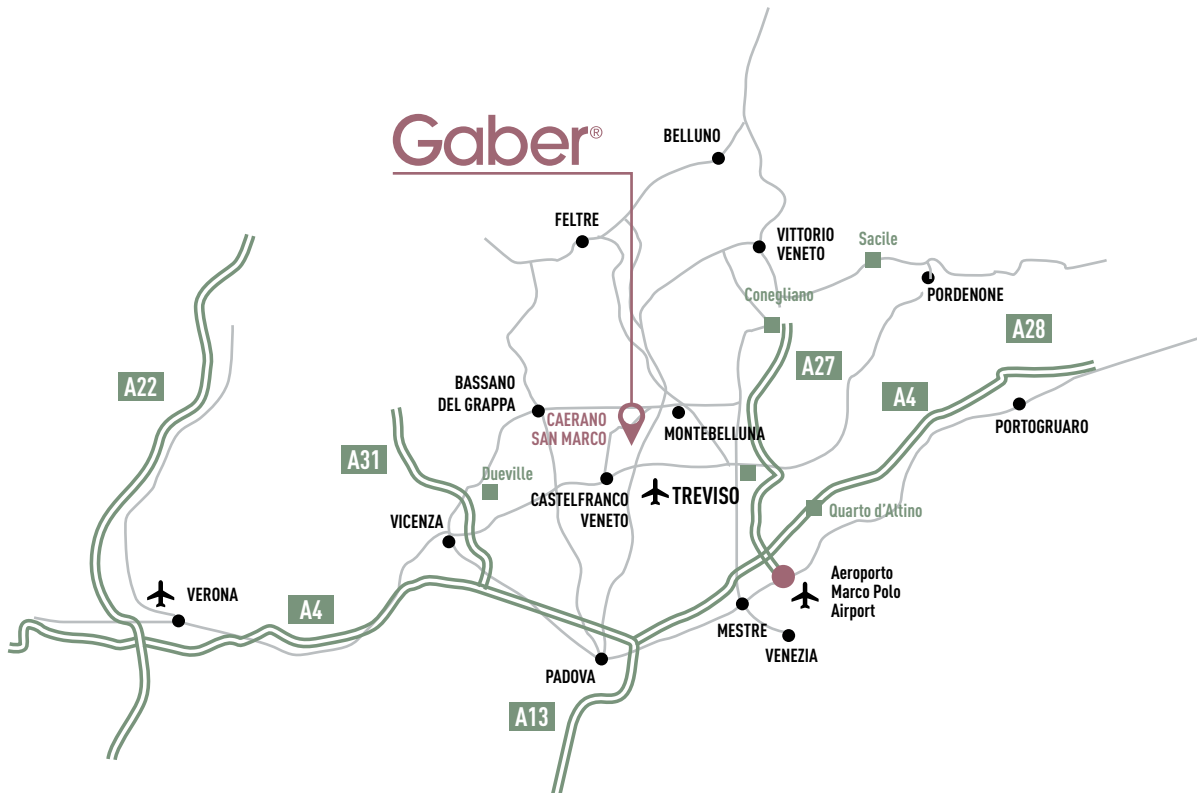

**Gaber**  
Via Altivole, 3  
31031 Caerano San Marco (TV)  
ITALY  
+39 0423 915521  
info@gaber.it  
gaber.it

Gaber®

[gaber.it](http://gaber.it)

**Gaber®**

**Tables Collection**



**Gaber®**

GABER® Indoor & Outdoor Quality Design, Made in Italy

# Contract

Designs, develop and production



Gaber

Gaber designs, develops and produces furniture for the contract world, responding to the needs of design, flexibility and quality thanks to the high level of expertise achieved in the molding of plastics and metal processing. Production efficiency, continuous research and great attention to details make it possible to create practical, versatile and long-lasting furnishing solutions.

The total customization at the service of the world of architecture and design make us the ideal partner to style and furnish different environments, all dedicated to hospitality and therefore to the well-being of people sharing moments of work, meeting and relaxation. Projects in which each product has its strong, distinctive features and is part of a furnishing system designed to interpret evolving needs, new times and new meeting places.

Gaber progetta, sviluppa e produce arredi per il mondo contract rispondendo a esigenze di design, flessibilità e qualità grazie all'altissima expertise raggiunta nello stampaggio di materie plastiche e nella lavorazione del metallo. Efficienza produttiva, ricerca continua e grande attenzione ai dettagli permettono di realizzare soluzioni di arredo pratiche, versatili e durature.

La totale customizzazione al servizio del mondo dell'architettura e del design ci rendono il partner ideale per arredare diversi ambienti, tutti orientati all'hospitality e quindi al benessere di persone che condividono momenti di lavoro, di incontro e di relax. Progetti in cui ogni prodotto ha un forte carattere distintivo e si inserisce in un sistema di arredo studiato per interpretare esigenze in divenire, nuovi tempi e nuovi luoghi di incontro.

# Made in Italy

As pure expression of Made in Italy, Gaber interprets that balance between craftsmanship and industry by creating furnishings able of satisfying the tastes and needs of its international audience, with a high level of customization and a wide range of finishes.

Pura espressione del Made in Italy, Gaber interpreta quell'equilibrio tra artigianato e industria che si realizza in arredi capaci di soddisfare gusti ed esigenze di un pubblico internazionale, con un alto livello di personalizzazione e ampia gamma di finiture.



# COVERINGS & finishes

Coverings and finishes stimulate and impact on the senses: they are decorations, textures and patterns. Research, technology and developments assist Gaber® in the production of new emotional tactile feelings on surfaces made for Interior Design. This is the place where your products are born.

Rivestimenti e finiture superficiali suscitano emozioni e sollecitano i sensi: che si tratti di decori, texture o trame. Ricerca, sperimentazione e tecnologia aiutano Gaber® nella produzione di nuovi effetti tattili ed emozionali per le superfici destinate all'Interior Design. Questo è il posto dove nascono i vostri prodotti.



#keepdreaming on gaber.it

## CONTENTS / INDICE

### HIGH TABLES



ARKET  
Studio Eurolinea  
P. 21



BANKET  
Studio Eurolinea  
P. 63



CLARO SLIM  
Studio Eurolinea  
P. 57



FORMAT  
Studio Eurolinea  
P. 69



ICS  
Studio Eurolinea  
P. 67



ROLLER  
Studio Eurolinea  
P. 80



SIMPLY  
Studio Eurolinea  
P. 71



STEP  
Studio Eurolinea  
P. 65



SURFY 2027  
Studio Eurolinea  
P. 19



TOGETHER  
Marc Sadler  
P. 31

### COFFEE TABLES



ARKET  
Studio Eurolinea  
P. 21



CLARO  
Studio Eurolinea  
P. 51



CLARO SLIM  
Studio Eurolinea  
P. 55



LINK  
Stefano Sandonà  
P. 47



MINUSH  
Studio Eurolinea  
P. 49



ROLLER  
Studio Eurolinea  
P. 77



SATURNINO  
Studio Eurolinea  
P. 45



SIMPLY  
Studio Eurolinea  
P. 71



STEFANO 3-POD  
Studio Eurolinea  
P. 37



STEFANINO  
Studio Eurolinea  
P. 39



WOODY  
Favaretto & Partners  
P. 41

TABLES



AGILE  
Studio Eurolinea  
P. 25



ARKET  
Studio Eurolinea  
P. 21



CHARME  
Studio Eurolinea  
P. 27



CLARO  
Studio Eurolinea  
P. 51



CLARO SLIM  
Studio Eurolinea  
P. 56



FORMAT  
Studio Eurolinea  
P. 69



HUG  
Studio Eurolinea  
P. 73



JACKIE  
Studio Eurolinea  
P. 83



LOGIN  
Studio Eurolinea  
P. 23



MUG  
Studio Eurolinea  
P. 75



PROFILO  
Studio Eurolinea  
P. 61



ROLLER  
Studio Eurolinea  
P. 79



SATURNO  
Studio Eurolinea  
P. 43



SIMPLY  
Studio Eurolinea  
P. 71



SPACE  
Studio Eurolinea  
P. 59



STEFANO  
Studio Eurolinea  
P. 35



SURFY 2027  
Studio Eurolinea  
P. 15



TOGETHER  
Marc Sadler  
P. 29

ACCESSORIES



CULTURE  
Malene Flensted  
Urup  
P. 85

TABLES

TKITT  
COLLECTION



TKITT.BG3K  
P. 89



TKITT.BG3L  
P. 91



TKITT.BG4IP  
P. 97



TKITT.BG4J  
P. 94



TKITT.BG4K  
P. 93



TKITT.BGA3L  
P. 91



TKITT.BGA4K  
P. 93



TKITT.BGPJ  
P. 95



TKITT.BGPK  
P. 94



TKITT.DPBT54  
P. 103



TKITT.BQAJ  
P. 107



TKITT.BQJ  
P. 107



TKITT.BRK  
P. 105



TKITT.BTAK  
P. 99



TKITT.BTAK54  
P. 101



TKITT.BTK  
P. 99



TKITT.BTK54  
P. 101



TKITT.STAKY  
P. 109



TCONT.STADY  
P. 111

TABLE  
TOPS



STANDARD  
COMPACTOP  
SURFACES  
P. 114



SPECIAL  
COMPACTOP  
SURFACES  
FULLCOLOR  
P. 115



SPECIAL  
COMPACTOP  
SURFACES  
FENIX  
P. 116



SPECIAL  
COMPACTOP  
SURFACES 12  
P. 117



SPECIAL  
COMPACTOP  
SURFACES 10  
P. 118



STANDARD  
LAMINATED  
SURFACES 22  
P. 120



STANDARD  
LAMINATED  
SURFACES 50  
P. 121



SPECIAL  
LAMINATED  
SURFACES  
WOOD EFFECT 25  
P. 122



SPECIAL  
LAMINATED  
SURFACES  
FENIX 25  
P. 123



IRON  
SURFACES  
P. 124



TECHNO  
POLYMER  
TABLE TOPS  
P. 125

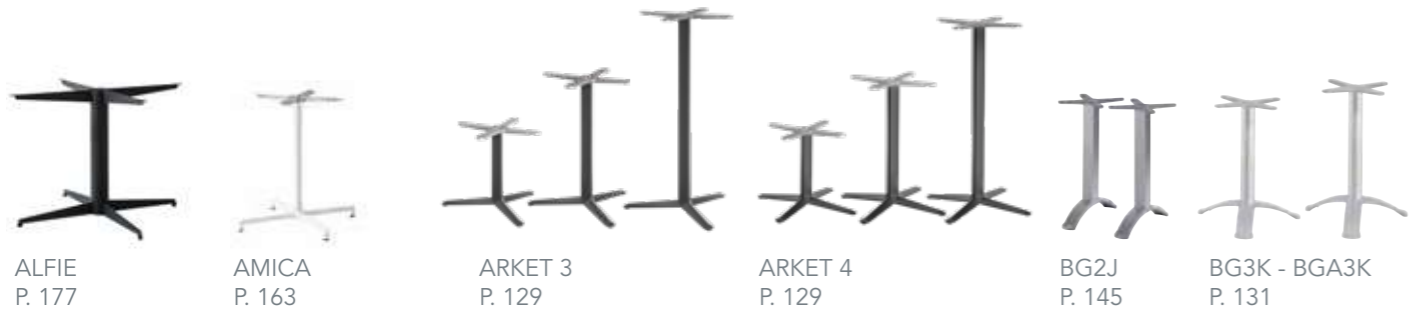























# AWARDS: SUCCESS IN PROGRESS



# AWARDS: SUCCESS IN PROGRESS

Gaber has won prestigious awards in the field on safety and design. These recognitions are a testament to Gaber's unstinting commitment to design and the focus on originality and innovation we bring to the world.  
Gaber ha vinto prestigiosi premi in ambito di sicurezza e design. Questi riconoscimenti testimoniano il nostro continuo impegno nella progettazione e il focus in originalità e innovazione che portiamo nel mondo.

 <p><b>JOE</b> 2011 Stefano Sandonà</p> <p><b>GOOD DESIGN AWARD 2011</b> OF CHICAGO ATHENAEUM : MUSEUM OF ARCHITECTURE AND DESIGN</p>	 <p><b>COLORFIVE</b> 2011 Stefano Sandonà</p> <p><b>GOOD DESIGN AWARD 2011</b> OF CHICAGO ATHENAEUM : MUSEUM OF ARCHITECTURE AND DESIGN</p> <p>red dot design award honorable mention 2011</p>	 <p><b>TOGETHER</b> 2011 Marc Sadler</p> <p><b>GOOD DESIGN AWARD 2011</b> OF CHICAGO ATHENAEUM : MUSEUM OF ARCHITECTURE AND DESIGN</p> <p>Interior Innovation Award 2012 Winner</p>	 <p><b>BLOG chair and stool</b> 2012 Stefano Sandonà</p> <p><b>GOOD DESIGN AWARD 2012</b> OF CHICAGO ATHENAEUM : MUSEUM OF ARCHITECTURE AND DESIGN</p>	 <p><b>STILLY</b> 2014 Studio Eurolinea Design</p> <p><b>GOOD DESIGN AWARD 2014</b> OF CHICAGO ATHENAEUM : MUSEUM OF ARCHITECTURE AND DESIGN</p> <p>GERMAN DESIGN AWARD NOMINEE 2016</p>	 <p><b>ISIDORO</b> 2015 Favaretto &amp; Partners</p> <p><b>GOOD DESIGN AWARD 2015</b> OF CHICAGO ATHENAEUM : MUSEUM OF ARCHITECTURE AND DESIGN</p> <p>YOUNG DESIGN HP</p>	 <p><b>ISIDORA</b> 2015 Favaretto &amp; Partners</p> <p><b>GOOD DESIGN AWARD 2015</b> OF CHICAGO ATHENAEUM : MUSEUM OF ARCHITECTURE AND DESIGN</p> <p>YOUNG DESIGN HP</p> <p>red dot design award winner 2016</p>	 <p><b>CHOPPY</b> 2015 Favaretto &amp; Partners</p> <p><b>GOOD DESIGN AWARD 2015</b> OF CHICAGO ATHENAEUM : MUSEUM OF ARCHITECTURE AND DESIGN</p>
 <p><b>OCTO</b> 2012 Stefano Sandonà</p> <p><b>GOOD DESIGN AWARD 2012</b> OF CHICAGO ATHENAEUM : MUSEUM OF ARCHITECTURE AND DESIGN</p> <p>product design award 2013</p>	 <p><b>MORE</b> 2012 Favaretto &amp; Partners</p> <p><b>YOUNG DESIGN</b></p> <p>Interior Innovation Award 2012 Winner</p>	 <p><b>PANAMA chair and stool</b> 2013 Stefano Sandonà</p> <p><b>red dot design award winner 2013</b></p> <p>Interior Innovation Award 2014 Winner</p>	 <p><b>AKAMI</b> 2013 Stefano Sandonà</p> <p><b>GOOD DESIGN AWARD 2013</b> OF CHICAGO ATHENAEUM : MUSEUM OF ARCHITECTURE AND DESIGN</p> <p>Interior Innovation Award 2014 Winner</p> <p>product design award 2015</p>	 <p><b>AVENICA</b> 2016 Studio Eurolinea Design</p> <p><b>GOOD DESIGN AWARD 2016</b> OF CHICAGO ATHENAEUM : MUSEUM OF ARCHITECTURE AND DESIGN</p>	 <p><b>PLACE</b> 2016 Favaretto &amp; Partners</p> <p><b>GOOD DESIGN AWARD 2016</b> OF CHICAGO ATHENAEUM : MUSEUM OF ARCHITECTURE AND DESIGN</p> <p>FX</p>	 <p><b>DIAMANTE</b> 2016 Studio Eurolinea Design</p> <p><b>INNOVATIONSPREIS ARCHITECTURE+ OFFICE</b></p> <p>FX</p>	 <p><b>ELODIE</b> 2016 Marc Sadler</p> <p><b>red dot design award winner 2017</b></p> <p><b>GOOD DESIGN AWARD 2017</b> OF CHICAGO ATHENAEUM : MUSEUM OF ARCHITECTURE AND DESIGN</p> <p>INNOVATIONSPREIS ARCHITECTURE+ OFFICE</p> <p>FX</p> <p>product design award 2018</p> <p>BIGSEE PRODUCT DESIGN AWARD 2018</p>
 <p><b>SLOT chair and stool</b> 2013 Favaretto &amp; Partners</p> <p><b>GOOD DESIGN AWARD 2013</b> OF CHICAGO ATHENAEUM : MUSEUM OF ARCHITECTURE AND DESIGN</p>	 <p><b>CHEVALET</b> 2013 Favaretto &amp; Partners</p> <p>Interior Innovation Award 2014 Winner</p> <p><b>GOOD DESIGN AWARD 2014</b> OF CHICAGO ATHENAEUM : MUSEUM OF ARCHITECTURE AND DESIGN</p>	 <p><b>BASKET CHAIR</b> 2013 Alessandro Busana</p> <p>FX</p> <p>Interior Innovation Award 2014 Winner</p> <p><b>GOOD DESIGN AWARD 2014</b> OF CHICAGO ATHENAEUM : MUSEUM OF ARCHITECTURE AND DESIGN</p> <p>product design award 2015</p>	 <p><b>EPICA</b> 2014 Marc Sadler</p> <p>Interior Innovation Award 2015 Winner</p> <p><b>GOOD DESIGN AWARD 2015</b> OF CHICAGO ATHENAEUM : MUSEUM OF ARCHITECTURE AND DESIGN</p> <p>red dot design award winner 2015</p>	 <p><b>CLIPPERTON</b> 2017 Marc Sadler</p> <p><b>INNOVATIONSPREIS ARCHITECTURE+ OFFICE</b></p> <p><b>GOOD DESIGN AWARD 2017</b> OF CHICAGO ATHENAEUM : MUSEUM OF ARCHITECTURE AND DESIGN</p>	 <p><b>ABUELA</b> 2018 Favaretto &amp; Partners</p> <p>FX</p> <p><b>GOOD DESIGN AWARD 2018</b> OF CHICAGO ATHENAEUM : MUSEUM OF ARCHITECTURE AND DESIGN</p>	 <p><b>JUBEL</b> 2019 Forsix Design</p> <p>FX</p> <p>product design award 2019</p>	

**TABLES**  
**Collection**

# Surfy 2027

Studio Eurolinea Design



Only for compactop /  
solo per compactop

Frame Color / Colore Struttura



Compactop Top Color / Colore Piano Compactop

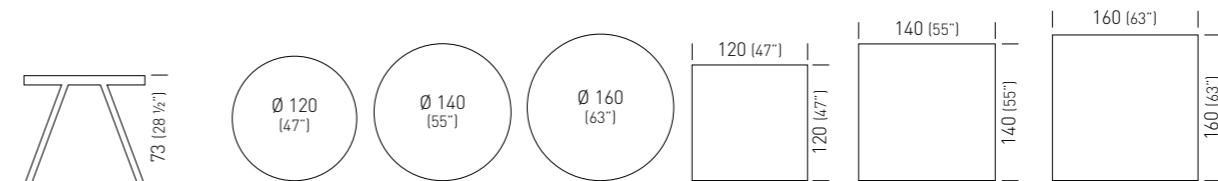
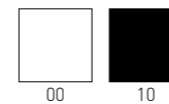

## Surfy Outdoor 2027 Round

diam. 120Compactop TSROC280.\_-\_/H73  
diam. 140Compactop TSROC286.\_-\_/H73  
diam. 160Compactop TSROC292.\_-\_/H73

0.71m<sup>3</sup> / 35kg / 1pcs  
0.90m<sup>3</sup> / 41kg / 1pcs  
1.1m<sup>3</sup> / 49kg / 1pcs

## Surfy Outdoor 2027 Square

120x120Compactop TSROC283.\_-\_/H73  
140x140Compactop TSROC289.\_-\_/H73  
160x160Compactop TSROC295.\_-\_/H73

0.71m<sup>3</sup> / 39kg / 1pcs  
0.90m<sup>3</sup> / 49kg / 1pcs  
1.1m<sup>3</sup> / 59kg / 1pcs

Table collection, available for Indoor or Outdoor purpose, meeting tables and modular desks, part of the "2027" system, suitable for completing hospitality and office settings with integrated design.

The tables are made with painted metal structures and Laminate or Compactop table-tops, available with metal fairlead solutions.

Collezione tavoli, tavoli per esterni, tavoli meeting e scrivanie modulari, parte del sistema "2027", adatti a completare con lo stesso design progetti integrati di ospitalità ed ufficio.

I tavoli sono realizzati con strutture in metallo verniciato e piani in Laminato o Compactop, disponibili con soluzioni passacavi in metallo.



# Surfy Hub 2027



Frame Color / Colore Struttura



Laminated Top Color / Colore Piano Laminato

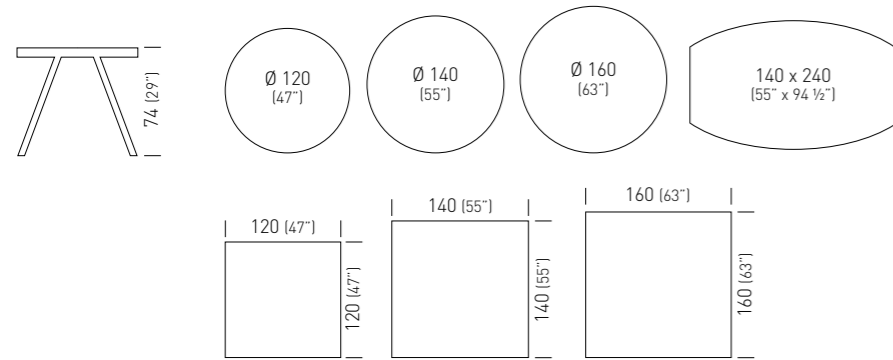
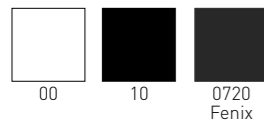

## Surfy Hub 2027 Round

diam. 120laminated	TSRHL260._-_/H74	0.71m³ / 30kg / 1pcs
diam. 120lam.fenix	TSRHL260.0720-_/H74	0.71m³ / 30kg / 1pcs
diam. 140laminated	TSRHL262._-_/H74	0.90m³ / 37kg / 1pcs
diam. 140lam.fenix	TSRHL262.0720-_/H74	0.90m³ / 37kg / 1pcs
diam. 160laminated	TSRHL264._-_/H74	1.1m³ / 43kg / 1pcs
diam. 160lam.fenix	TSRHL264.0720-_/H74	1.1m³ / 43kg / 1pcs



## Surfy Hub 2027 Square

120x120laminated	TSRHL261._-_/H74	0.71m³ / 34kg / 1pcs
120x120lam.fenix	TSRHL261.0720-_/H74	0.71m³ / 34kg / 1pcs
140x140laminated	TSRHL263._-_/H74	0.90m³ / 41kg / 1pcs
140x140lam.fenix	TSRHL263.0720-_/H74	0.90m³ / 41kg / 1pcs
160x160laminated	TSRHL265._-_/H74	1.1m³ / 50kg / 1pcs
160x160lam.fenix	TSRHL265.0720-_/H74	1.1m³ / 50kg / 1pcs



## Surfy Hub 2027 Oval

140x240laminated	TSRHL275._-_/H74	1.50m³ / 74kg / 1pcs
140x240lam.fenix	TSRHL275.0720-_/H74	1.50m³ / 74kg / 1pcs

Frame Color / Colore Struttura

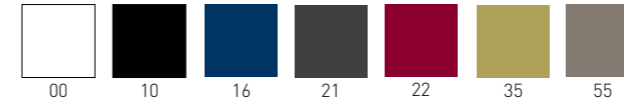

Laminated Top Color / Colore Piano Laminato

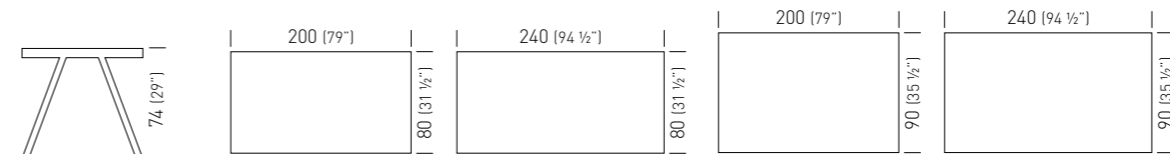
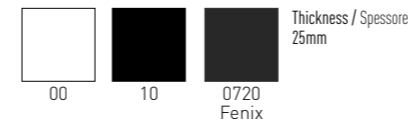

## Surfy Hub 2027 Rectangle

80x200laminated	TSRHL266._-_/H74	0.76m³ / 41kg / 1pcs
80x200lam.fenix	TSRHL266.0720-_/H74	0.76m³ / 41kg / 1pcs
80x240laminated	TSRHL267._-_/H74	0.90m³ / 46kg / 1pcs
80x240lam.fenix	TSRHL267.0720-_/H74	0.90m³ / 46kg / 1pcs
90x200laminated	TSRHL268._-_/H74	0.90m³ / 44kg / 1pcs
90x200lam.fenix	TSRHL268.0720-_/H74	0.90m³ / 44kg / 1pcs
90x240laminated	TSRHL269._-_/H74	1.0m³ / 51kg / 1pcs
90x240lam.fenix	TSRHL269.0720-_/H74	1.0m³ / 51kg / 1pcs

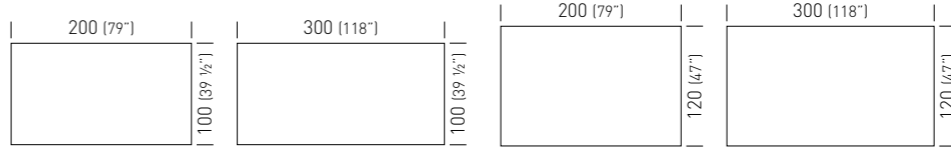
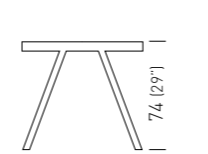

## Surfy Hub 2027 Rectangle

100x200laminated	TSRHL270._-_/H74	0.92m³ / 45kg / 1pcs
100x200lam.fenix	TSRHL270.0720-_/H74	0.92m³ / 45kg / 1pcs
100x300laminated	TSRHL271._-_/H74	1.4m³ / 65kg / 1pcs
100x300lam.fenix	TSRHL271.0720-_/H74	1.4m³ / 65kg / 1pcs
120x200laminated	TSRHL272._-_/H74	1.1m³ / 52kg / 1pcs
120x200lam.fenix	TSRHL272.0720-_/H74	1.1m³ / 52kg / 1pcs
120x300laminated	TSRHL273._-_/H74	1.6m³ / 74kg / 1pcs
120x300lam.fenix	TSRHL273.0720-_/H74	1.6m³ / 74kg / 1pcs

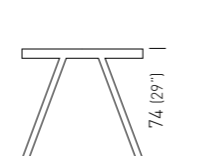

## Surfy Hub 2027 Rectangle

140x300laminated	TSRHL276._-_/H74	1.9m³ / 81kg / 1pcs
140x300lam.fenix	TSRHL276.0720-_/H74	1.9m³ / 81kg / 1pcs

# Surfy Desk 2027

Frame Color / Colore Struttura

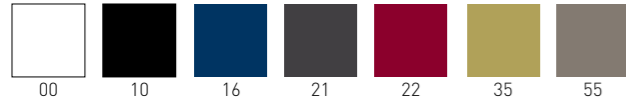

Laminated Top Color / Colore Piano Laminato

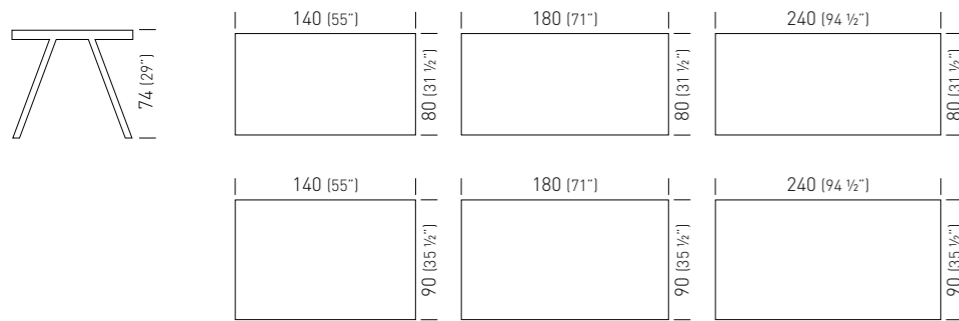

**Surfy Desk 2027**

80x140laminated	TSRDL300.___/H74	0.41m³ / 32kg / 1pcs
80x180laminated	TSRDL301.___/H74	0.60m³ / 38kg / 1pcs
80x240laminated	TSRDL302.___/H74	0.90m³ / 46.5kg / 1pcs
90x140laminated	TSRDL303.___/H74	0.65m³ / 34kg / 1pcs
90x180laminated	TSRDL304.___/H74	0.80m³ / 40kg / 1pcs
90x240laminated	TSRDL305.___/H74	1.0m³ / 50kg / 1pcs

Laminated Top Color / Colore Piano Laminato

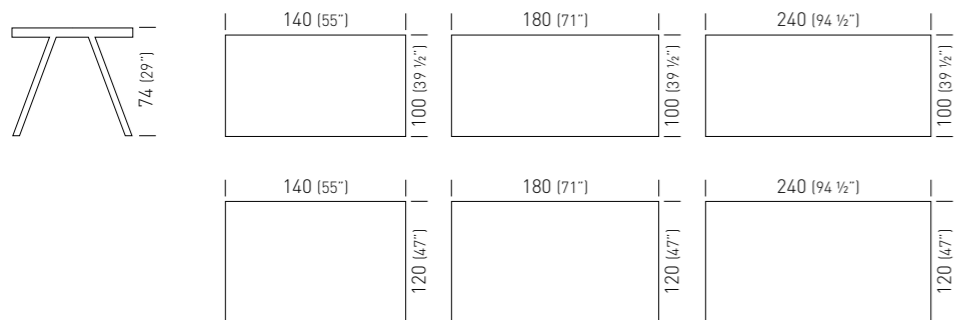
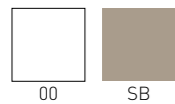

**Surfy Desk 2027**

100x140laminated	TSRDL306.___/H74	0.70m³ / 40.5kg / 1pcs
100x180laminated	TSRDL307.___/H74	0.85m³ / 49kg / 1pcs
100x240laminated	TSRDL308.___/H74	1.1m³ / 62kg / 1pcs
120x140laminated	TSRDL309.___/H74	0.8m³ / 46kg / 1pcs
120x180laminated	TSRDL310.___/H74	1.0m³ / 56kg / 1pcs
120x240laminated	TSRDL311.___/H74	1.3m³ / 72kg / 1pcs

Frame Color / Colore Struttura



Laminated Top Color / Colore Piano Laminato

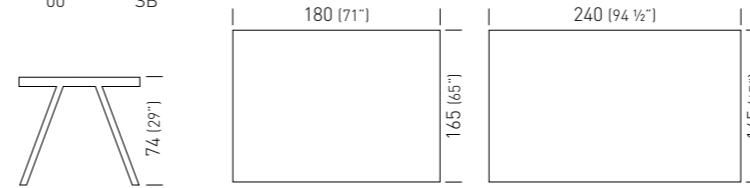
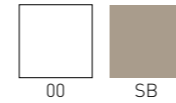

**Surfy Desk Bridge 2027**

165x180laminated	TSRDL314.___/H74	0.90m³ / 87kg / 1pcs
165x240laminated	TSRDL316.___/H74	1.20m³ / 109kg / 1pcs

Laminated Top Color / Colore Piano Laminato

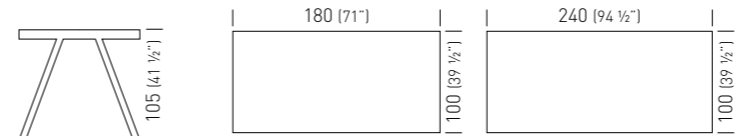
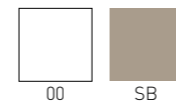

**Surfy High Desk 2027**

100x180laminated	TSRDL307.___/H105	0.85m³ / 57kg / 1pcs
100x240laminated	TSRDL308.___/H105	1.10m³ / 69kg / 1pcs

# Arket

Studio Eurolinea Design



Frame Color / Colore Struttura

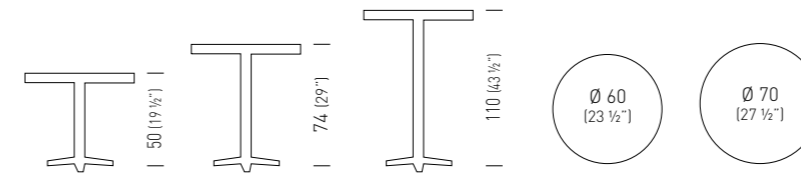
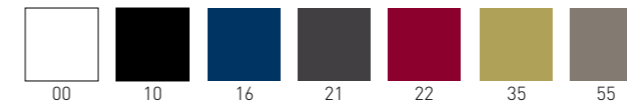

diam.60	TAK3I030._._/H50		0.075m³ / 10kg / 1pcs
diam.70	TAK3I032._._/H50		0.085m³ / 10.5kg / 1pcs
diam.60	TAK3I030._._/H74		0.075m³ / 10.5kg / 1pcs
diam.70	TAK3I032._._/H74		0.085m³ / 11kg / 1pcs
diam.60	TAK3I030._._/H110		0.105m³ / 11kg / 1pcs

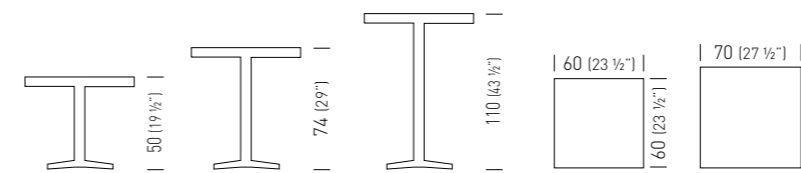

60x60	TAK4I031._._/H50		0.075m³ / 12kg / 1pcs
70x70	TAK4I033._._/H50		0.085m³ / 13.5kg / 1pcs
60x60	TAK4I031._._/H74		0.075m³ / 12.5kg / 1pcs
70x70	TAK4I033._._/H74		0.085m³ / 14kg / 1pcs
60x60	TAK4I031._._/H110		0.105m³ / 13kg / 1pcs

The new Arket table collection is made using basic geometrics - radii and linear sections intersect to achieve distinctly intuitive shapes.

The aluminum bases have three or four spokes with adjustable feet, and the stems come in sections with three or four surfaces.

The shelves are made of steel: the tables are thus painted in a solid color and easily customizable and adaptable to the most prestigious of installations.

La nuova collezione di tavoli Arket è realizzata utilizzando le geometrie più elementari, raggi e sezioni lineari si intersecano per ricavare forme essenziali ed intuitive.

I basamenti, a tre o quattro razze, e gli steli, a sezioni con tre o quattro superfici, sono realizzati in alluminio.

I ripiani sono realizzati in acciaio: i tavoli sono così verniciati in tinta unita e facilmente personalizzabili ed adattabili alle più prestigiose installazioni.

# Login

Studio Eurolinea Design



Table with co-injected metal frame with techno polymer, wooden legs, Laminated Top.  
Tavolo con struttura in metallo sovrastampato con tecnopolimero, gambe in legno massello di faggio o rovere, piani in Laminato.



Frame Color / Colore Struttura

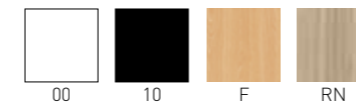

Laminated Top Color / Colore Piano Laminato



Special Finishes / Finiture Speciali

**Laminated:** Special Laminated Surfaces Wood Effect 25 (p. 122) available on demand (min. 20pcs each code)  
Special Laminated Surfaces Wood Effect 25 (p. 122) disponibile su richiesta (min. 20pcs per codice)  
Special Laminated Surfaces Fenix 25 (p. 123) available on demand (min. 20pcs each code)  
Special Laminated Surfaces Fenix 25 (p. 123) disponibile su richiesta (min. 20pcs per codice)

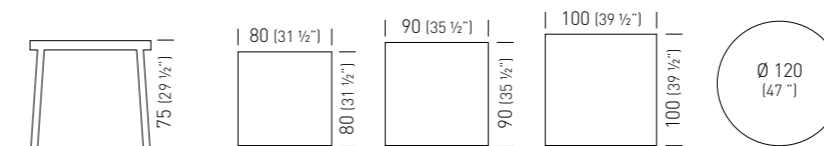

80x80laminated	TLOGL230._____/H75	0.35m <sup>3</sup> / 21kg / 1pcs
90x90laminated	TLOGL232._____/H75	0.46m <sup>3</sup> / 22kg / 1pcs
100x100laminated	TLOGL234._____/H75	0.46m <sup>3</sup> / 24kg / 1pcs
diam. 120laminated	TLOGL236._____/H75	0.80m <sup>3</sup> / 26kg / 1pcs

# Agile

Studio Eurolinea Design



The multifunctional Agile Table Collection reveals essential aesthetics. Available with rectangular solid laminate tops, the Agile Collection utilizes techno-polymer leg in different colors, supported by a steel frame. Agile è una collezione di tavoli multifunzionale dall'estetica ricercata ed essenziale. Realizzato con piani rettangolari in laminato, Agile utilizza gambe in tecnopolimero in diverse colorazioni, supportate da una cornice in acciaio.

Technopolymer Frame Color / Colore Struttura Tecnopolimero

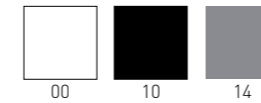

Laminated Top Color / Colore Piano Laminato



Special Finishes / Finiture Speciali

**Laminated:** Special Laminated Surfaces Wood Effect 25 (p. 122) available on demand (min. 20pcs each code)  
 Special Laminated Surfaces Wood Effect 25 (p. 122) disponibile su richiesta (min. 20pcs per codice)  
 Special Laminated Surfaces Fenix 25 (p. 123) available on demand (min. 20pcs each code)  
 Special Laminated Surfaces Fenix 25 (p. 123) disponibile su richiesta (min. 20pcs per codice)

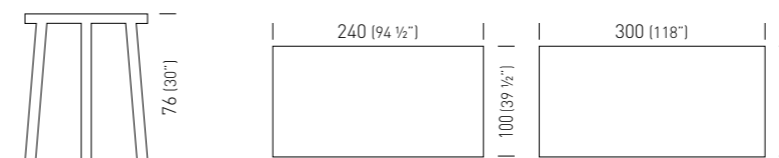

100x240laminated TAGIL250.\_\_/6H75 1.40m³ / 55kg / 1pcs

100x300laminated TAGIL254.\_\_/6H75 1.80m³ / 65kg / 1pcs

# Charme

Studio Eurolinea Design



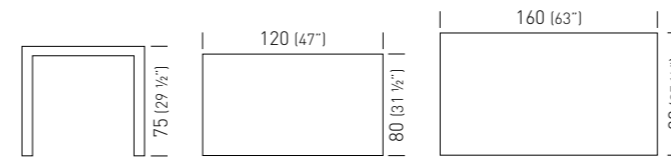
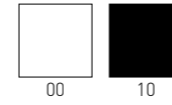

Colors / Colori



80x120  
90x160

TCHAI400.\_/H75  
TCHAI402.\_/H75

 0.48m<sup>3</sup> / 20kg / 1pcs  
 0.72m<sup>3</sup> / 22kg / 1pcs

Iron table top, painted metal frame.  
Tavolo con piano Iron  
e struttura in metallo verniciato.



# Together



Marc Sadler Design

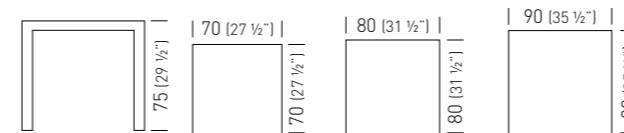

Natural Oak wood table top and polycarbonate legs:  
transparent, solid white, solid black.  
Tavolo con piano in legno di rovere,  
gambe in policarbonato trasparente, bianche o nere.

Technopolymer Frame Color / Colore Struttura Tecnopolimero      Top Color / Colore Piano



70x70	TTOGL420._._/H75	 0.40m <sup>3</sup> / 16kg / 1pcs
80x80	TTOGL422._._/H75	 0.40m <sup>3</sup> / 18kg / 1pcs
90x90	TTOGL424._._/H75	 0.40m <sup>3</sup> / 20kg / 1pcs

# Together

Marc Sadler Design



Natural Oak wood table top and frame.  
Tavolo con piano e struttura in legno di rovere.



Wooden Frame Color / Colore Struttura Legno



Top Color / Colore Piano

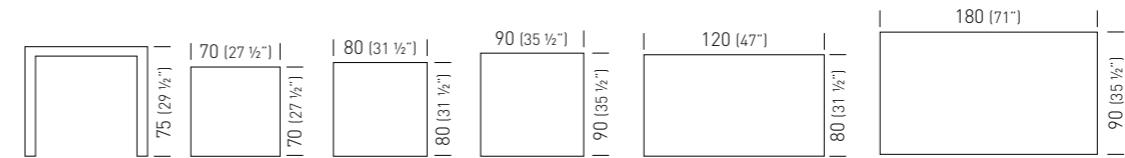

70x70	TTOGL420._._/H75		0.40m <sup>3</sup> / 16kg / 1pcs
80x80	TTOGL422._._/H75		0.40m <sup>3</sup> / 18kg / 1pcs
90x90	TTOGL424._._/H75		0.40m <sup>3</sup> / 20kg / 1pcs
120x80	TTOGL426._._/H75		0.48m <sup>3</sup> / 24kg / 1pcs
180x90	TTOGL428._._/H75		0.80m <sup>3</sup> / 33kg / 1pcs

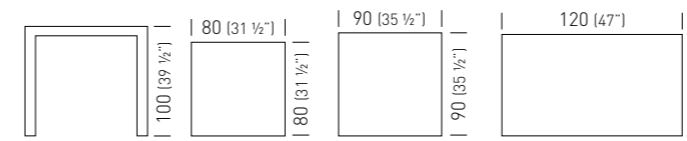

80x80	TTOGL422._._/H100		0.42m <sup>3</sup> / 22kg / 1pcs
90x90	TTOGL424._._/H100		0.42m <sup>3</sup> / 24kg / 1pcs
120x80	TTOGL426._._/H100		0.50m <sup>3</sup> / 27kg / 1pcs

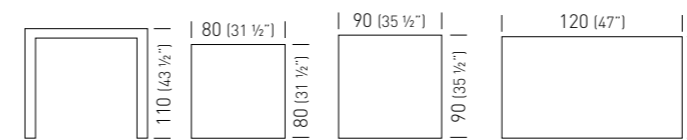

80x80	TTOGL422._._/H110		0.42m <sup>3</sup> / 22kg / 1pcs
90x90	TTOGL424._._/H110		0.42m <sup>3</sup> / 24kg / 1pcs
120x80	TTOGL426._._/H110		0.50m <sup>3</sup> / 27kg / 1pcs



# Stefano

Studio Eurolinea Design



Compactop table-top and beech legs.  
Or with technopolymer legs,  
suitable for outdoor use. Lightweight and functional.  
Tavolo con piano Compactop e gambe in legno di faggio.  
Disponibile anche con gambe in tecnopolimero,  
adatte all'uso esterno. Leggero e funzionale.

#### Wooden Frame Color / Colore Struttura Legno

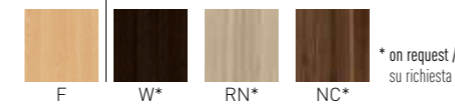

\* on request /  
su richiesta

#### Top Color / Colore Piano

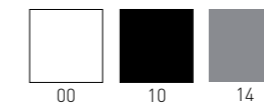

#### Special Finishes / Finiture Speciali

**Compactop:** Special Compactop Surfaces 12 (p. 117) available on demand (min. 20pcs each code)  
Special Compactop Surfaces 12 (p. 117) disponibile su richiesta (min. 20pcs per codice)

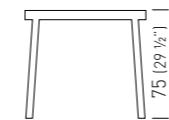

diam.80  
diam.80 fullcolor straight edge / bordo dritto (min 5pcs)  
diam.80 fullcolor inclined edge / bordo inclinato (min 5pcs)  
diam.100  
diam.100 fullcolor straight edge / bordo dritto (min 5pcs)  
diam.100 fullcolor inclined edge / bordo inclinato (min 5pcs)  
diam.120  
diam.120 fullcolor straight edge / bordo dritto (min 5pcs)  
diam.120 fullcolor inclined edge / bordo inclinato (min 5pcs)  
diam.140  
diam.140 fullcolor straight edge / bordo dritto (min 5pcs)  
diam.140 fullcolor inclined edge / bordo inclinato (min 5pcs)

TSTEC102.\_.\_/H75 0.4m³ / 18kg / 1pcs  
TSTEC103.\_.\_/H75 0.4m³ / 18kg / 1pcs  
TSTEC104.\_.\_/H75 0.4m³ / 18kg / 1pcs  
TSTEC114.\_.\_/H75 0.58m³ / 19kg / 1pcs  
TSTEC115.\_.\_/H75 0.58m³ / 19kg / 1pcs  
TSTEC116.\_.\_/H75 0.58m³ / 19kg / 1pcs  
TSTEC122.\_.\_/H75 0.71m³ / 20kg / 1pcs  
TSTEC123.\_.\_/H75 0.71m³ / 20kg / 1pcs  
TSTEC124.\_.\_/H75 0.71m³ / 20kg / 1pcs  
TSTEC129.\_.\_/H75 0.87m³ / 24kg / 1pcs  
TSTEC130.\_.\_/H75 0.87m³ / 24kg / 1pcs  
TSTEC131.\_.\_/H75 0.87m³ / 24kg / 1pcs

#### Technopolymer Frame Color / Colore Struttura Tecnopolimero



#### Top Color / Colore Piano

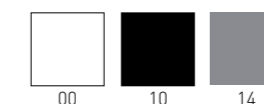

#### Special Finishes / Finiture Speciali

**Compactop:** Special Compactop Surfaces 12 (p. 117) available on demand (min. 20pcs each code)  
Special Compactop Surfaces 12 (p. 117) disponibile su richiesta (min. 20pcs per codice)

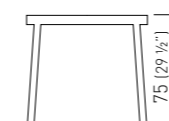

diam.80  
diam.80 fullcolor straight edge / bordo dritto (min 5pcs)  
diam.80 fullcolor inclined edge / bordo inclinato (min 5pcs)  
diam.100  
diam.100 fullcolor straight edge / bordo dritto (min 5pcs)  
diam.100 fullcolor inclined edge / bordo inclinato (min 5pcs)  
diam.120  
diam.120 fullcolor straight edge / bordo dritto (min 5pcs)  
diam.120 fullcolor inclined edge / bordo inclinato (min 5pcs)  
diam.140  
diam.140 fullcolor straight edge / bordo dritto (min 5pcs)  
diam.140 fullcolor inclined edge / bordo inclinato (min 5pcs)

TSTEC102.\_.\_/H75 0.4m³ / 18kg / 1pcs  
TSTEC103.\_.\_/H75 0.4m³ / 18kg / 1pcs  
TSTEC104.\_.\_/H75 0.4m³ / 18kg / 1pcs  
TSTEC114.\_.\_/H75 0.58m³ / 19kg / 1pcs  
TSTEC115.\_.\_/H75 0.58m³ / 19kg / 1pcs  
TSTEC116.\_.\_/H75 0.58m³ / 19kg / 1pcs  
TSTEC122.\_.\_/H75 0.71m³ / 20kg / 1pcs  
TSTEC123.\_.\_/H75 0.71m³ / 20kg / 1pcs  
TSTEC124.\_.\_/H75 0.71m³ / 20kg / 1pcs  
TSTEC129.\_.\_/H75 0.87m³ / 24kg / 1pcs  
TSTEC130.\_.\_/H75 0.87m³ / 24kg / 1pcs  
TSTEC131.\_.\_/H75 0.87m³ / 24kg / 1pcs

# Stefano

Studio Eurolinea Design



Compactop table-top and beech legs.  
Or with technopolymer legs,  
suitable for outdoor use. Lightweight and functional.  
Tavolo con piano Compactop e gambe in legno di faggio.  
Disponibile anche con gambe in tecnopolimero,  
adatte all'uso esterno. Leggero e funzionale.



#### Wooden Frame Color / Colore Struttura Legno

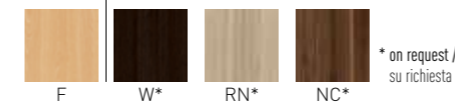

#### Top Color / Colore Piano

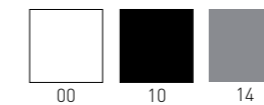

#### Special Finishes / Finiture Speciali

**Compactop:** Special Compactop Surfaces 12 (p. 117) available on demand (min. 20pcs each code)  
Special Compactop Surfaces 12 (p. 117) disponibile su richiesta (min. 20pcs per codice)

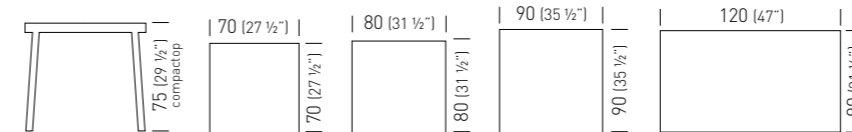

- 70x70
- 70x70 fullcolor straight edge / bordo dritto (min 5pcs)
- 70x70 fullcolor inclined edge / bordo inclinato (min 5pcs)
- 80x80
- 80x80 fullcolor straight edge / bordo dritto (min 5pcs)
- 80x80 fullcolor inclined edge / bordo inclinato (min 5pcs)
- 90x90
- 90x90 fullcolor straight edge / bordo dritto (min 5pcs)
- 90x90 fullcolor inclined edge / bordo inclinato (min 5pcs)
- 120x80
- 120x80 fullcolor straight edge / bordo dritto (min 5pcs)
- 120x80 fullcolor inclined edge / bordo inclinato (min 5pcs)

- TSTEC098.\_.\_/H75 0.40m³ / 17kg / 1pcs
- TSTEC099.\_.\_/H75 0.40m³ / 17kg / 1pcs
- TSTEC100.\_.\_/H75 0.40m³ / 17kg / 1pcs
- TSTEC106.\_.\_/H75 0.40m³ / 18kg / 1pcs
- TSTEC107.\_.\_/H75 0.40m³ / 18kg / 1pcs
- TSTEC108.\_.\_/H75 0.40m³ / 18kg / 1pcs
- TSTEC110.\_.\_/H75 0.40m³ / 18.5kg / 1pcs
- TSTEC111.\_.\_/H75 0.40m³ / 18.5kg / 1pcs
- TSTEC112.\_.\_/H75 0.40m³ / 18.5kg / 1pcs
- TSTEC126.\_.\_/H75 0.52m³ / 20kg / 1pcs
- TSTEC127.\_.\_/H75 0.52m³ / 20kg / 1pcs
- TSTEC128.\_.\_/H75 0.52m³ / 20kg / 1pcs

#### Technopolymer Frame Color / Colore Struttura Tecnopolimero



#### Top Color / Colore Piano

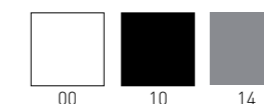

#### Special Finishes / Finiture Speciali

**Compactop:** Special Compactop Surfaces 12 (p. 117) available on demand (min. 20pcs each code)  
Special Compactop Surfaces 12 (p. 117) disponibile su richiesta (min. 20pcs per codice)

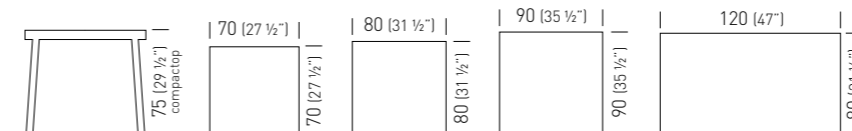

- 70x70
- 70x70 fullcolor straight edge / bordo dritto (min 5pcs)
- 70x70 fullcolor inclined edge / bordo inclinato (min 5pcs)
- 80x80
- 80x80 fullcolor straight edge / bordo dritto (min 5pcs)
- 80x80 fullcolor inclined edge / bordo inclinato (min 5pcs)
- 90x90
- 90x90 fullcolor straight edge / bordo dritto (min 5pcs)
- 90x90 fullcolor inclined edge / bordo inclinato (min 5pcs)
- 120x80
- 120x80 fullcolor straight edge / bordo dritto (min 5pcs)
- 120x80 fullcolor inclined edge / bordo inclinato (min 5pcs)

- TSTEC098.\_.\_/H75 0.40m³ / 17kg / 1pcs
- TSTEC099.\_.\_/H75 0.40m³ / 17kg / 1pcs
- TSTEC100.\_.\_/H75 0.40m³ / 17kg / 1pcs
- TSTEC106.\_.\_/H75 0.40m³ / 18kg / 1pcs
- TSTEC107.\_.\_/H75 0.40m³ / 18kg / 1pcs
- TSTEC108.\_.\_/H75 0.40m³ / 18kg / 1pcs
- TSTEC110.\_.\_/H75 0.40m³ / 18.5kg / 1pcs
- TSTEC111.\_.\_/H75 0.40m³ / 18.5kg / 1pcs
- TSTEC112.\_.\_/H75 0.40m³ / 18.5kg / 1pcs
- TSTEC126.\_.\_/H75 0.52m³ / 20kg / 1pcs
- TSTEC127.\_.\_/H75 0.52m³ / 20kg / 1pcs
- TSTEC128.\_.\_/H75 0.52m³ / 20kg / 1pcs

# Stefano 3-Pod

Studio Eurolinea Design



Wooden Frame Color / Colore Struttura Legno



Top Color / Colore Piano

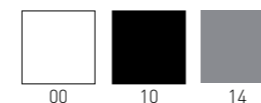

Special Finishes / Finiture Speciali

**Compactop:** Special Compactop Surfaces Fullcolor (p. 115) white available on demand (min. 5pcs each code).  
Special Compactop Surfaces Fullcolor (p. 115) bianco disponibile su richiesta (min. 5pcs per codice).

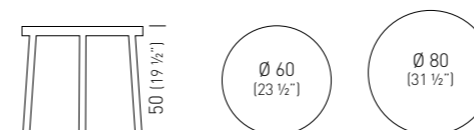

diam.60  
diam.80

TSTEC090. \_\_-\_/3H50  
TSTEC102. \_\_-\_/3H50

0.30m³ / 17kg / 1pcs  
 0.40m³ / 18kg / 1pcs

Waiting areas and Coffee Table,  
Compactop with three beech legs.  
Tavolino attesa con piano Compactop  
e tre gambe in legno di faggio.

# Stefanino

Studio Eurolinea Design



Waiting areas and Coffee Table,  
Compactop with beech legs.  
Tavolino attesa con piano Compactop  
e gambe in legno di faggio.

Wooden Frame Color / Colore Struttura Legno

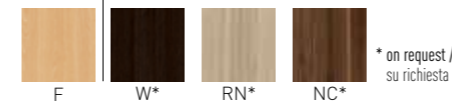

Top Color / Colore Piano

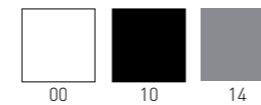

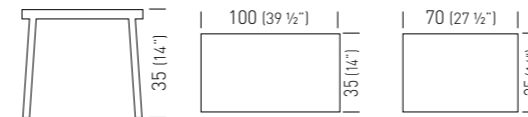

Fullcolor



100x35  
70x35

TSTEC118. \_\_-\_\_ /H35  
TSTEC094. \_\_-\_\_ /H35

 0.34m³ / 10kg / 1pcs  
 0.34m³ / 7kg / 1pcs

# Woody

Favaretto & Partners Design



Wooden Frame Color / Colore Struttura Legno



F

Top Color / Colore Piano



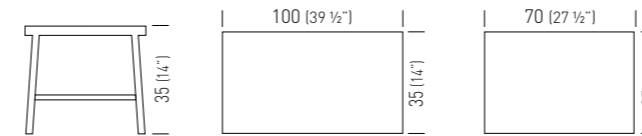

00

Fullcolor



100x35  
70x35

TW00C132.00-F/H35  
TW00C130.00-F/H35

 0.18m<sup>3</sup> / 12kg / 1pcs  
 0.13m<sup>3</sup> / 9kg / 1pcs

Waiting areas and Coffee Table,  
double Compactop deck and beech legs.  
Tavolino attesa con doppio piano Compactop  
e gambe in legno di faggio.



# Saturno

Studio Eurolinea Design



Compactop with painted aluminum frame.  
Tavolo con piano Compactop e struttura in alluminio verniciato.



Base Color / Colore Base



Top Color / Colore Piano

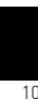

Special Finishes / Finiture Speciali

**Compactop:** Special Compactop Surfaces Fullcolor (p. 115) white available on demand (min. 5pcs each code).  
Special Compactop Surfaces Fullcolor (p. 115) bianco disponibile su richiesta (min. 5pcs per codice).  
Special Compactop Surfaces 12 (p. 117) available on demand (min. 20pcs each code).  
Special Compactop Surfaces 12 (p. 117) disponibile su richiesta (min. 20pcs per codice).



diam.80	TSATC142._._/H72	0.56m³ / 28kg / 1pcs
diam.100	TSATC146._._/H72	0.74m³ / 30kg / 1pcs
diam.120	TSATC150._._/H72	0.87m³ / 33kg / 1pcs

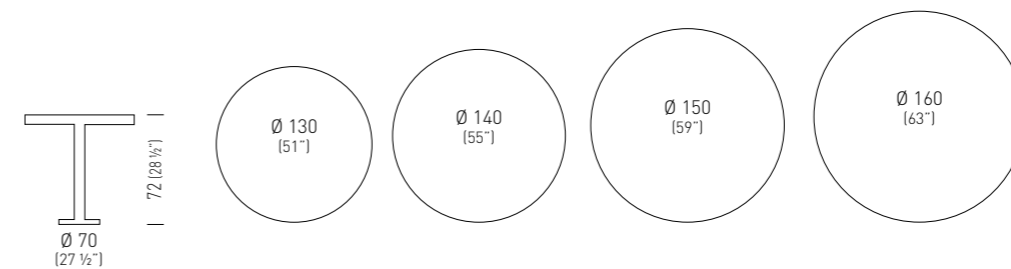

diam.130	TSATC153._._/H72	0.90m³ / 50kg / 1pcs
diam.140	TSATC156._._/H72	0.90m³ / 53kg / 1pcs
diam.150	TSATC159._._/H72	0.90m³ / 56kg / 1pcs
diam.160	TSATC162._._/H72	1.10m³ / 59kg / 1pcs

# Saturnino

Studio Eurolinea Design



Base Color / Colore Base

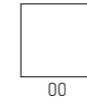

00

Top Color / Colore Piano

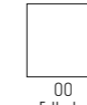

00  
Fullcolor

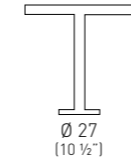

Ø 27  
(10 1/2")

50 (19 1/2")



Ø 50  
(19 1/2")

diam.50

TSATC140.\_.\_/H50

 0.3m³ / 10kg / 1pcs

Waiting areas and Coffee Table,  
Compactop with painted aluminum frame.  
Tavolino attesa con piano Compactop  
e struttura in alluminio verniciato.

# Link

Stefano Sandonà Design



Frame Color / Colore Struttura

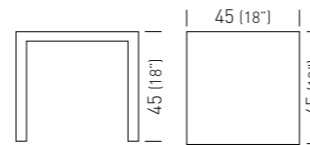

45x45

TLNKI025\_/\_/H45

 0.18m<sup>3</sup> / 7kg / 1pcs

Waiting areas and Coffee Table,  
painted metal structure suitable for outdoor purpose.  
Tavolino attesa, struttura in metallo  
verniciato per utilizzo esterno.



# Minush

Studio Eurolinea Design



Technopolymer Frame Color / Colore Struttura Tecnopolimero

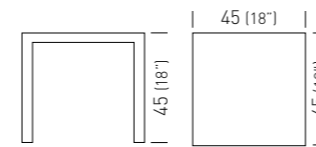
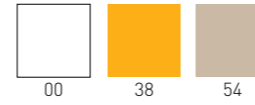

45x45

TMINT024.\_/H45

 0.13m<sup>3</sup> / 8kg / 2pcs

Technopolymer waiting areas  
and Coffee Table.  
Tavolino attesa in tecnopolimero.

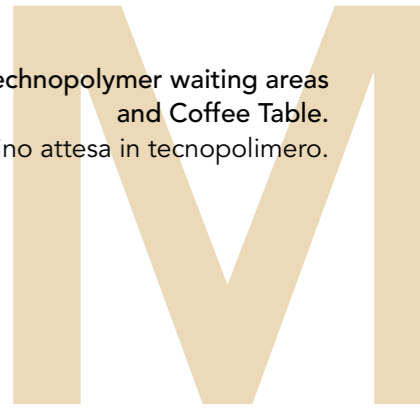

# Claro

Studio Eurolinea Design



Frame Color / Colore Struttura

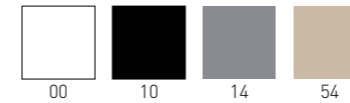

Compactop Color / Colore Piano Compactop

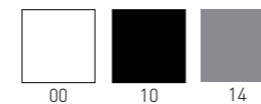

Laminated Top Color / Colore Piano Laminato



Special Finishes / Finiture Speciali

**Compactop:** Special Compactop Surfaces 12 (p. 117) available on demand (min. 20pcs each code)  
Special Compactop Surfaces 12 (p. 117) disponibile su richiesta (min. 20pcs per codice).  
**Laminated:** Special Laminated Surfaces Wood Effect 25 (p. 122) available on demand (min. 20pcs each code)  
Special Laminated Surfaces Wood Effect 25 (p. 122) disponibile su richiesta (min. 20pcs per codice)  
Special Laminated Surfaces Fenix 25 (p. 123) available on demand (min. 20pcs each code)  
Special Laminated Surfaces Fenix 25 (p. 123) disponibile su richiesta (min. 20pcs per codice)

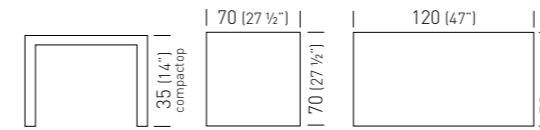

70x70compactop	TCLAC570._._/H35		0.24m <sup>3</sup> / 20kg / 1pcs
70x70laminated	TCLAL580._._/H35		0.24m <sup>3</sup> / 20kg / 1pcs
70x70fullcolor (min 5pcs)	TCLAC571.00._./H35		0.24m <sup>3</sup> / 20kg / 1pcs

70x120compactop	TCLAC572._._/H35		0.36m <sup>3</sup> / 25kg / 1pcs
70x120laminated	TCLAL582._._/H35		0.36m <sup>3</sup> / 25kg / 1pcs
70x120fullcolor (min 5pcs)	TCLAC573.00._./H35		0.36m <sup>3</sup> / 25kg / 1pcs

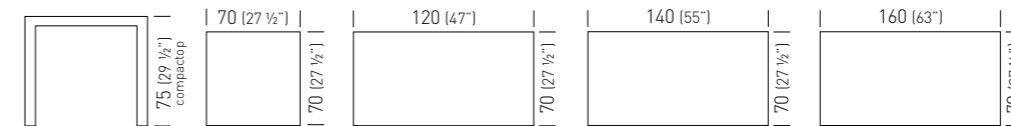

70x70compactop	TCLAC570._._/H75		0.24m <sup>3</sup> / 22kg / 1pcs
70x70laminated	TCLAL580._._/H75		0.24m <sup>3</sup> / 22kg / 1pcs
70x70fullcolor (min 5pcs)	TCLAC571.00._./H75		0.24m <sup>3</sup> / 22kg / 1pcs

70x120compactop	TCLAC572._._/H75		0.36m <sup>3</sup> / 27kg / 1pcs
70x120laminated	TCLAL582._._/H75		0.36m <sup>3</sup> / 27kg / 1pcs
70x120fullcolor (min 5pcs)	TCLAC573.00._./H75		0.36m <sup>3</sup> / 27kg / 1pcs

70x140compactop	TCLAC574._._/H75		0.41m <sup>3</sup> / 31kg / 1pcs
70x140laminated	TCLAL584._._/H75		0.41m <sup>3</sup> / 31kg / 1pcs
70x140fullcolor (min 5pcs)	TCLAC575.00._./H75		0.41m <sup>3</sup> / 31kg / 1pcs

70x160compactop	TCLAC576._._/H75		0.46m <sup>3</sup> / 35kg / 1pcs
70x160laminated	TCLAL586._._/H75		0.46m <sup>3</sup> / 35kg / 1pcs
70x160fullcolor (min 5pcs)	TCLAC577.00._./H75		0.46m <sup>3</sup> / 35kg / 1pcs

Table with co-injected metal frame with techno polymer, Compactop or laminated top. Suitable for outdoor purpose with Compactop. Tavolo con struttura in metallo sovrastampato con tecnopolimero, piano in Compactop o laminato. Con piano Compactop, adatto anche all'uso esterno.



Only for compactop / solo per compactop



Only for compactop / solo per compactop

Frame Color / Colore Struttura

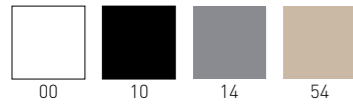

Compactop Color / Colore Piano Compactop

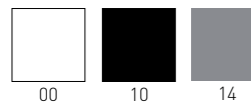

Laminated Top Color / Colore Piano Laminato



Special Finishes / Finiture Speciali

**Compactop:** Special Compactop Surfaces 12 (p.117) available on demand (min. 20pcs each code)  
Special Compactop Surfaces 12 (p. 117) disponibile su richiesta (min. 20pcs per codice).  
**Laminated:** Special Laminated Surfaces Wood Effect 25 (p. 122) available on demand (min. 20pcs each code)  
Special Laminated Surfaces Wood Effect 25 (p. 122) disponibile su richiesta (min. 20pcs per codice)  
Special Laminated Surfaces Fenix 25 (p. 123) available on demand (min. 20pcs each code)  
Special Laminated Surfaces Fenix 25 (p. 123) disponibile su richiesta (min. 20pcs per codice)

Frame Color / Colore Struttura

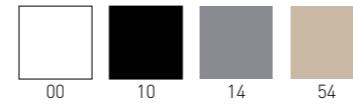

Compactop Color / Colore Piano Compactop

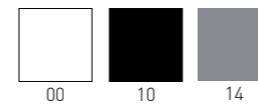

Laminated Top Color / Colore Piano Laminato



Special Finishes / Finiture Speciali

**Compactop:** Special Compactop Surfaces 12 (p.117) available on demand (min. 20pcs each code)  
Special Compactop Surfaces 12 (p. 117) disponibile su richiesta (min. 20pcs per codice).  
**Laminated:** Special Laminated Surfaces Wood Effect 25 (p. 122) available on demand (min. 20pcs each code)  
Special Laminated Surfaces Wood Effect 25 (p. 122) disponibile su richiesta (min. 20pcs per codice)  
Special Laminated Surfaces Fenix 25 (p. 123) available on demand (min. 20pcs each code)  
Special Laminated Surfaces Fenix 25 (p. 123) disponibile su richiesta (min. 20pcs per codice)

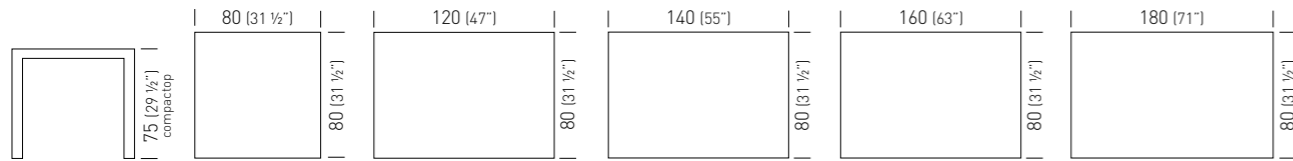

80x80compactop	TCLAC590.___/H75		0.24m <sup>3</sup> / 31kg / 1pcs
80x80laminated	TCLAL600.___/H75		0.24m <sup>3</sup> / 31kg / 1pcs
80x80fullcolor (min 5pcs)	TCLAC591.00-_/H75		0.24m <sup>3</sup> / 31kg / 1pcs
80x120compactop	TCLAC592.___/H75		0.36m <sup>3</sup> / 38kg / 1pcs
80x120laminated	TCLAL602.___/H75		0.36m <sup>3</sup> / 38kg / 1pcs
80x120fullcolor (min 5pcs)	TCLAC593.00-_/H75		0.36m <sup>3</sup> / 38kg / 1pcs
80x140compactop	TCLAC594.___/H75		0.41m <sup>3</sup> / 40kg / 1pcs
80x140laminated	TCLAL604.___/H75		0.41m <sup>3</sup> / 40kg / 1pcs
80x140fullcolor (min 5pcs)	TCLAC595.00-_/H75		0.41m <sup>3</sup> / 40kg / 1pcs
80x160compactop	TCLAC596.___/H75		0.46m <sup>3</sup> / 42kg / 1pcs
80x160laminated	TCLAL606.___/H75		0.46m <sup>3</sup> / 42kg / 1pcs
80x160fullcolor (min 5pcs)	TCLAC597.00-_/H75		0.46m <sup>3</sup> / 42kg / 1pcs
80x180compactop	TCLAC598.___/H75		0.60m <sup>3</sup> / 44kg / 1pcs
80x180laminated	TCLAL608.___/H75		0.60m <sup>3</sup> / 44kg / 1pcs
80x180fullcolor (min 5pcs)	TCLAC599.00-_/H75		0.60m <sup>3</sup> / 44kg / 1pcs

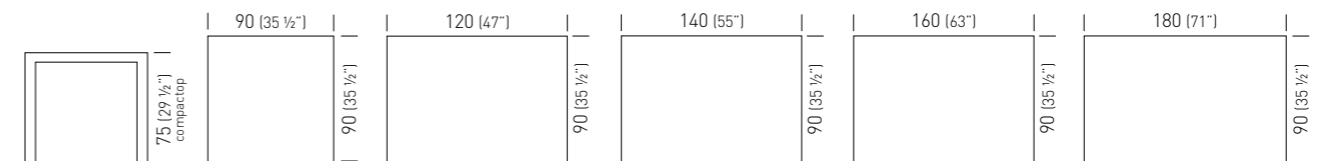

90x90compactop	TCLAC610.___/H75		0.54m <sup>3</sup> / 33kg / 1pcs
90x90laminated	TCLAL620.___/H75		0.54m <sup>3</sup> / 33kg / 1pcs
90x90fullcolor (min 5pcs)	TCLAC611.00-_/H75		0.54m <sup>3</sup> / 33kg / 1pcs
90x120compactop	TCLAC612.___/H75		0.54m <sup>3</sup> / 36kg / 1pcs
90x120laminated	TCLAL622.___/H75		0.54m <sup>3</sup> / 36kg / 1pcs
90x120fullcolor (min 5pcs)	TCLAC613.00-_/H75		0.54m <sup>3</sup> / 36kg / 1pcs
90x140compactop	TCLAC614.___/H75		0.65m <sup>3</sup> / 39kg / 1pcs
90x140laminated	TCLAL624.___/H75		0.65m <sup>3</sup> / 39kg / 1pcs
90x140fullcolor (min 5pcs)	TCLAC615.00-_/H75		0.65m <sup>3</sup> / 39kg / 1pcs
90x160compactop	TCLAC616.___/H75		0.75m <sup>3</sup> / 41kg / 1pcs
90x160laminated	TCLAL626.___/H75		0.75m <sup>3</sup> / 41kg / 1pcs
90x160fullcolor (min 5pcs)	TCLAC617.00-_/H75		0.75m <sup>3</sup> / 41kg / 1pcs
90x180compactop	TCLAC618.___/H75		0.80m <sup>3</sup> / 43kg / 1pcs
90x180laminated	TCLAL628.___/H75		0.80m <sup>3</sup> / 43kg / 1pcs
90x180fullcolor (min 5pcs)	TCLAC619.00-_/H75		0.80m <sup>3</sup> / 43kg / 1pcs
120x120laminated	TCLAL670.___/H75		0.70m <sup>3</sup> / 38kg / 1pcs
120x180laminated	TCLAL672.___/H75		1.00m <sup>3</sup> / 45kg / 1pcs

# Claro Slim

Studio Eurolinea Design



Frame Color / Colore Struttura

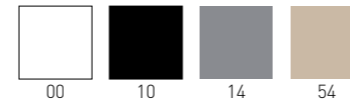

Compactop Color / Colore Piano Compactop

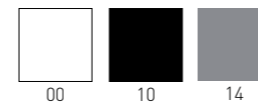

Laminated Top Color / Colore Piano Laminato



Special Finishes / Finiture Speciali

**Compactop:** Special Compactop Surfaces 10 (p.117) available on demand (min. 20pcs each code)  
Special Compactop Surfaces 10 (p. 117) disponibile su richiesta (min. 20pcs per codice).  
**Laminated:** Special Laminated Surfaces Wood Effect 25 (p. 122) available on demand (min. 20pcs each code)  
Special Laminated Surfaces Wood Effect 25 (p. 122) disponibile su richiesta (min. 20pcs per codice)  
Special Laminated Surfaces Fenix 25 (p. 123) available on demand (min. 20pcs each code)  
Special Laminated Surfaces Fenix 25 (p. 123) disponibile su richiesta (min. 20pcs per codice)

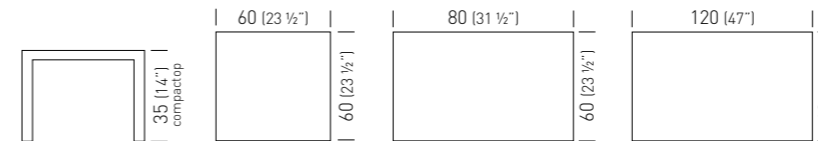

60x60compactop	TCLAC640.___/H35		0.15m <sup>3</sup> / 17kg / 1pcs
60x60laminated	TCLAL650.___/H35		0.15m <sup>3</sup> / 17kg / 1pcs
60x60fullcolor (min 5pcs)	TCLAC641.00-_/H35		0.15m <sup>3</sup> / 17kg / 1pcs
60x80compactop	TCLAC642.___/H35		0.18m <sup>3</sup> / 19kg / 1pcs
60x80laminated	TCLAL652.___/H35		0.18m <sup>3</sup> / 19kg / 1pcs
60x80fullcolor (min 5pcs)	TCLAC643.00-_/H35		0.18m <sup>3</sup> / 19kg / 1pcs
60x120compactop	TCLAC644.___/H35		0.36m <sup>3</sup> / 23kg / 1pcs
60x120laminated	TCLAL654.___/H35		0.36m <sup>3</sup> / 23kg / 1pcs
60x120fullcolor (min 5pcs)	TCLAC645.00-_/H35		0.36m <sup>3</sup> / 23kg / 1pcs

# Claro Slim

High table, Compactop or Laminated table top, painted metal frame.  
Tavolo alto con struttura in metallo verniciato, piano in Compactop o Laminato.



Only for compactop / solo per compactop



Only for Compactop / Solo per Compactop

## Frame Color / Colore Struttura

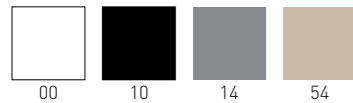

## Compactop Color / Colore Piano Compactop

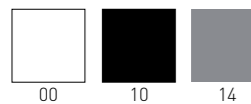

## Laminated Top Color / Colore Piano Laminato



## Special Finishes / Finiture Speciali

**Compactop:** Special Compactop Surfaces 10 (p. 118) available on demand (min. 20pcs each code)  
Special Compactop Surfaces 10 (p. 118) disponibile su richiesta (min. 20pcs per codice).  
**Laminated:** Special Laminated Surfaces Wood Effect 25 (p. 122) available on demand (min. 20pcs each code)  
Special Laminated Surfaces Wood Effect 25 (p. 122) disponibile su richiesta (min. 20pcs per codice)  
Special Laminated Surfaces Fenix 25 (p. 123) available on demand (min. 20pcs each code)  
Special Laminated Surfaces Fenix 25 (p. 123) disponibile su richiesta (min. 20pcs per codice)

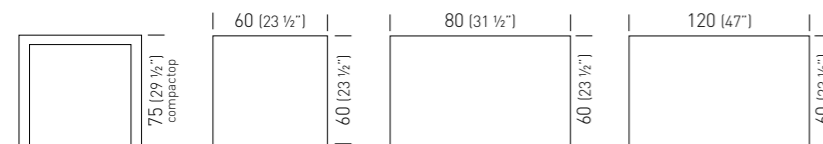

60x60compactop	TCLAC640.___/H75		0.15m <sup>3</sup> / 19kg / 1pcs
60x60laminated	TCLAL650.___/H75		0.15m <sup>3</sup> / 19kg / 1pcs
60x60fullcolor (min 5pcs)	TCLAC641.00-_/H75		0.15m <sup>3</sup> / 19kg / 1pcs
60x80compactop	TCLAC642.___/H75		0.18m <sup>3</sup> / 21kg / 1pcs
60x80laminated	TCLAL652.___/H75		0.18m <sup>3</sup> / 21kg / 1pcs
60x80fullcolor (min 5pcs)	TCLAC643.00-_/H75		0.18m <sup>3</sup> / 21kg / 1pcs
60x120compactop	TCLAC644.___/H75		0.36m <sup>3</sup> / 25kg / 1pcs
60x120laminated	TCLAL654.___/H75		0.36m <sup>3</sup> / 25kg / 1pcs
60x120fullcolor (min 5pcs)	TCLAC645.00-_/H75		0.36m <sup>3</sup> / 25kg / 1pcs

## Frame Color / Colore Struttura

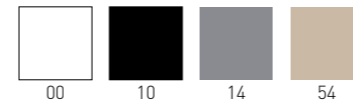

## Compactop Color / Colore Piano Compactop

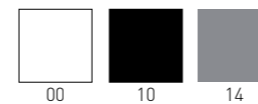

## Laminated Top Color / Colore Piano Laminato



## Special Finishes / Finiture Speciali

**Compactop:** Special Compactop Surfaces 10 (p. 118) available on demand (min. 20pcs each code)  
Special Compactop Surfaces 10 (p. 118) disponibile su richiesta (min. 20pcs per codice).  
**Laminated:** Special Laminated Surfaces Wood Effect 25 (p. 122) available on demand (min. 20pcs each code)  
Special Laminated Surfaces Wood Effect 25 (p. 122) disponibile su richiesta (min. 20pcs per codice)  
Special Laminated Surfaces Fenix 25 (p. 123) available on demand (min. 20pcs each code)  
Special Laminated Surfaces Fenix 25 (p. 123) disponibile su richiesta (min. 20pcs per codice)

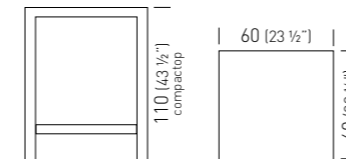

60x60compactop	TCLAC640.___/H110		0.20m <sup>3</sup> / 21kg / 1pcs
60x60laminated	TCLAL650.___/H110		0.20m <sup>3</sup> / 21kg / 1pcs
60x60fullcolor (min 5pcs)	TCLAC641.00-_/H110		0.20m <sup>3</sup> / 21kg / 1pcs

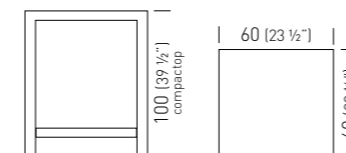

60x60compactop	TCLAC640.___/H100		0.20m <sup>3</sup> / 20kg / 1pcs
60x60laminated	TCLAL650.___/H100		0.20m <sup>3</sup> / 20kg / 1pcs
60x60fullcolor (min 5pcs)	TCLAC641.00-_/H100		0.20m <sup>3</sup> / 20kg / 1pcs

# Space

Studio Eurolinea Design



Frame Color / Colore Struttura



Compactop Color / Colore Piano Compactop

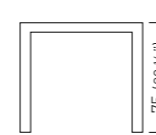

80x80  
90x90

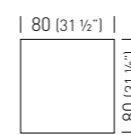

TSPAC410.\_-/H75  
TSPAC412.\_-/H75

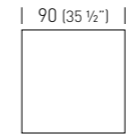

0.36m<sup>3</sup> / 19kg / 1pcs  
0.36m<sup>3</sup> / 21kg / 1pcs

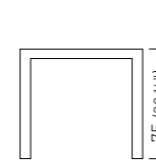

80x150  
90x150

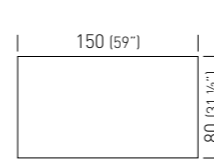

TSPAC414.\_-/H75  
TSPAC416.\_-/H75

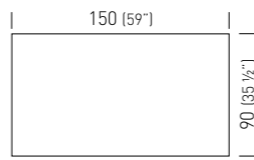

0.68m<sup>3</sup> / 28kg / 1pcs  
0.68m<sup>3</sup> / 30kg / 1pcs

Compactop with anodized aluminum frame.  
Tavolo con piano Compactop e struttura in alluminio anodizzato.



# Profilo

Studio Eurolinea Design

Compactop or Laminated table top with painted metal frame. Adjustable feet.  
Tavolo con struttura in metallo verniciato, piano in Compactop o Laminato. Piedini regolabili



#### Frame Color / Colore Struttura



#### Compactop Color / Colore Piano Compactop

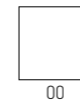

#### Laminated Top Color / Colore Piano Laminato

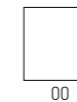

#### Special Finishes / Finiture Speciali

**Compactop:** Special Compactop Surfaces Fullcolor (p.115) white available on demand (min. 5pcs each code).  
Special Compactop Surfaces Fullcolor (p.115) bianco disponibile su richiesta (min. 5pcs per codice).  
Special Compactop Surfaces 12 (p.117) available on demand (min. 20pcs each code).  
Special Compactop Surfaces 12 (p.117) disponibile su richiesta (min. 20pcs per codice).  
**Laminated:** Special Laminated Surfaces Wood Effect 25 (p. 122) available on demand (min. 20pcs each code).  
Special Laminated Surfaces Wood Effect 25 (p.122) disponibile su richiesta (min. 20pcs per codice).  
Special Laminated Surfaces Fenix 25 (p. 123) available on demand (min. 20pcs each code).  
Special Laminated Surfaces Fenix 25 (p.123) disponibile su richiesta (min. 20pcs per codice).

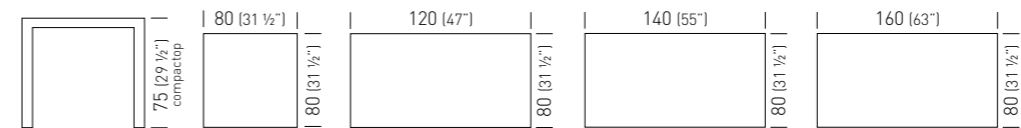

80x80compactop	TPROC500._._/H75		0.32m <sup>3</sup> / 24kg / 1pcs
80x80laminated	TPROL518._._/H75		0.32m <sup>3</sup> / 24kg / 1pcs
80x120compactop	TPROC502._._/H75		0.43m <sup>3</sup> / 29kg / 1pcs
80x120laminated	TPROL520._._/H75		0.43m <sup>3</sup> / 29kg / 1pcs
80x140compactop	TPROC504._._/H75		0.48m <sup>3</sup> / 33kg / 1pcs
80x140laminated	TPROL522._._/H75		0.48m <sup>3</sup> / 33kg / 1pcs
80x160compactop	TPROC506._._/H75		0.53m <sup>3</sup> / 38kg / 1pcs
80x160laminated	TPROL524._._/H75		0.53m <sup>3</sup> / 38kg / 1pcs

# Banket

Studio Eurolinea Design



High table, Compactop or Laminated table top,  
painted metal frame.  
Tavolo alto con struttura in metallo verniciato,  
piano in Compactop o Laminato.



Frame Color / Colore Struttura

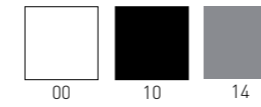

Compactop Color / Colore Piano Compactop

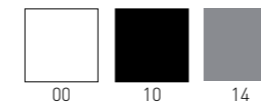

Laminated Top Color / Colore Piano Laminato



Special Finishes / Finiture Speciali

**Compactop:** Special Compactop Surfaces Fullcolor (p.115) white available on demand (min. 5pcs each code).  
Special Compactop Surfaces Fullcolor (p.115) bianco disponibile su richiesta (min. 5pcs per codice).  
Special Compactop Surfaces 12 (p.117) available on demand (min. 20pcs each code).  
Special Compactop Surfaces 12 (p.117) disponibile su richiesta (min. 20pcs per codice).  
**Laminated:** Special Laminated Surfaces Wood Effect 25 (p.122) available on demand (min. 20pcs each code).  
Special Laminated Surfaces Wood Effect 25 (p.122) disponibile su richiesta (min. 20pcs per codice).  
Special Laminated Surfaces Fenix 25 (p.123) available on demand (min. 20pcs each code).  
Special Laminated Surfaces Fenix 25 (p.123) disponibile su richiesta (min. 20pcs per codice).

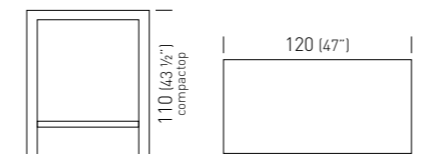

120x50compactop  
120x50laminated

TBNKC800.\_.\_/H110  
TBNKL804.\_.\_/H110

0.47m<sup>3</sup> / 18kg / 1pcs  
0.47m<sup>3</sup> / 18kg / 1pcs



# Step

Studio Eurolinea Design



Technopolymer Frame Color / Colore Struttura Tecnopolimero

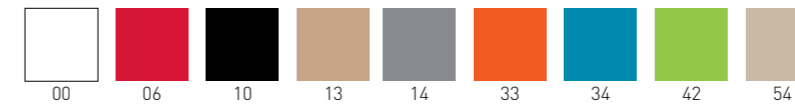

Compactop Color / Colore Piano Compactop

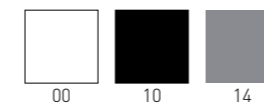

Special Finishes / Finiture Speciali

**Compactop:** Special Compactop Surfaces 12 (p.117) available on demand (min. 20pcs each code).  
Special Compactop Surfaces 12 (p.117) disponibile su richiesta (min. 20pcs per codice).

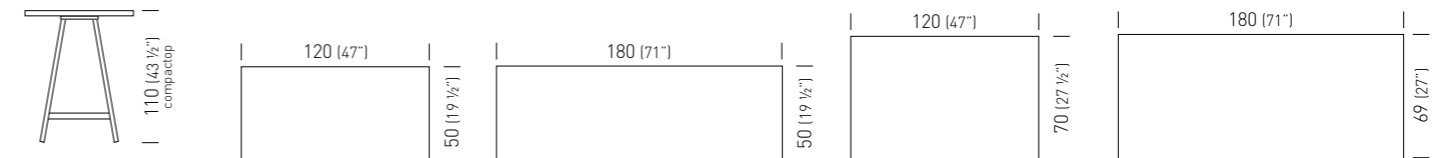

120x50	TSTPC820.00-_/H110		0.47m³ / 35kg / 1pcs
120x50fullcolor (min 5pcs)	TSTPC821.00-_/H110		0.47m³ / 35kg / 1pcs
120x70	TSTPC822.00-_/H110		0.48m³ / 36kg / 1pcs
120x70fullcolor (min 5pcs)	TSTPC823.00-_/H110		0.48m³ / 36kg / 1pcs
180x50	TSTPC824.00-_/H110		0.60m³ / 42kg / 1pcs
180x50fullcolor (min 5pcs)	TSTPC825.00-_/H110		0.60m³ / 42kg / 1pcs
180x69	TSTPC826.00-_/H110		0.60m³ / 43kg / 1pcs
180x69fullcolor (min 5pcs)	TSTPC827.00-_/H110		0.60m³ / 43kg / 1pcs

High table, co-injected metal frame with techno polymer, Compactop. Suitable for outdoor purpose. Tavolo alto con struttura in metallo sovrastampato con tecnopolimero, piano in Compactop. Adatto anche all'uso esterno.



# Ics

Studio Eurolinea Design



Frame Color / Colore Struttura

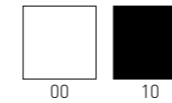

Compactop Color / Colore Piano Compactop

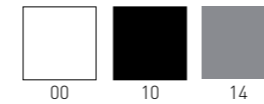

Laminated Top Color / Colore Piano Laminato



Special Finishes / Finiture Speciali

**Compactop:** Special Compactop Surfaces Fullcolor (p.115) white available on demand (min. 5pcs each code).  
Special Compactop Surfaces Fullcolor (p.115) bianco disponibile su richiesta (min. 5pcs per codice).  
Special Compactop Surfaces 12 (p.117) available on demand (min. 20pcs each code).  
Special Compactop Surfaces 12 (p.117) disponibile su richiesta (min. 20pcs per codice).  
**Laminated:** Special Laminated Surfaces Wood Effect 25 (p.122) available on demand (min. 20pcs each code).  
Special Laminated Surfaces Wood Effect 25 (p.122) disponibile su richiesta (min. 20pcs per codice).  
Special Laminated Surfaces Fenix 25 (p.123) available on demand (min. 20pcs each code).  
Special Laminated Surfaces Fenix 25 (p.123) disponibile su richiesta (min. 20pcs per codice).

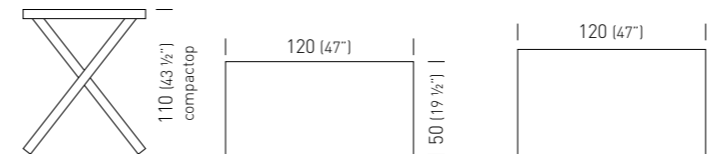

120x50compactop	TICSC830. _ _ /H110	0.47m³ / 25kg / 1pcs
120x50laminated	TICSL836. _ _ /H110	0.47m³ / 25kg / 1pcs
120x70compactop	TICSC832. _ _ /H110	0.48m³ / 26kg / 1pcs
120x70laminated	TICSL838. _ _ /H110	0.48m³ / 26kg / 1pcs

# Format

Studio Eurolinea Design



Frame Color / Colore Struttura

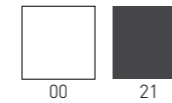

Compactop Color / Colore Piano Compactop

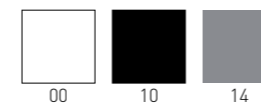

Special Finishes / Finiture Speciali

**Compactop:** Special Compactop Surfaces Fullcolor (p.115) white available on demand (min. 5pcs each code).  
Special Compactop Surfaces Fullcolor (p.115) bianco disponibile su richiesta (min. 5pcs per codice).  
Special Compactop Surfaces 12 (p.117) available on demand (min. 20pcs each code).  
Special Compactop Surfaces 12 (p.117) disponibile su richiesta (min. 20pcs per codice).

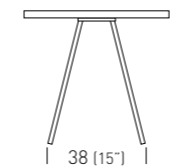

120x50  
120x70  
180x50  
180x69

TFORC840.\_.\_/H75 0.47m<sup>3</sup> / 23kg / 1pcs  
TFORC842.\_.\_/H75 0.48m<sup>3</sup> / 24kg / 1pcs  
TFORC844.\_.\_/H75 0.80m<sup>3</sup> / 25kg / 1pcs  
TFORC846.\_.\_/H75 0.80m<sup>3</sup> / 26kg / 1pcs

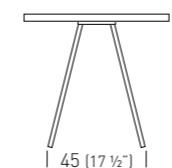

120x50  
120x70  
180x50  
180x69

TFORC840.\_.\_/H110 0.47m<sup>3</sup> / 25kg / 1pcs  
TFORC842.\_.\_/H110 0.48m<sup>3</sup> / 26kg / 1pcs  
TFORC844.\_.\_/H110 0.80m<sup>3</sup> / 27kg / 1pcs  
TFORC846.\_.\_/H110 0.80m<sup>3</sup> / 28kg / 1pcs

Table with metal painted frame and Compactop table top.  
Suitable for outdoor purpose. Adjustable feet.  
Tavolo con struttura in metallo verniciato, piano in Compactop.  
Adatto anche all'uso esterno. Piedini regolabili.

# Simply

Studio Eurolinea Design



Stackable table with laminated or Iron top and painted metal frame.  
Tavolo impilabile con piano in laminato o Iron e telaio in metallo verniciato.



Frame Color / Colore Struttura

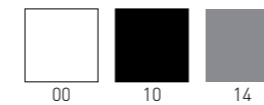

Iron Top Color / Colore Piano Iron

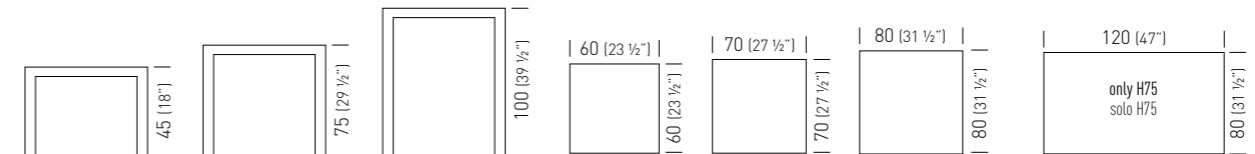
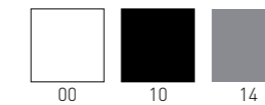

60x60	TSIMI430._._/H45		0.28m³ / 17.0kg / 1pcs
60x60	TSIMI430._._/H75		0.28m³ / 17.5kg / 1pcs
60x60	TSIMI430._._/H100		0.28m³ / 18.5kg / 1pcs
70x70	TSIMI432._._/H45		0.28m³ / 18.0kg / 1pcs
70x70	TSIMI432._._/H75		0.28m³ / 18.5kg / 1pcs
70x70	TSIMI432._._/H100		0.28m³ / 19.5kg / 1pcs
80x80	TSIMI434._._/H45		0.40m³ / 19.0kg / 1pcs
80x80	TSIMI434._._/H75		0.40m³ / 19.5kg / 1pcs
80x80	TSIMI434._._/H100		0.40m³ / 20.5kg / 1pcs
120x80	TSIMI436._._/H75		0.40m³ / 25.0kg / 1pcs

Frame Color / Colore Struttura

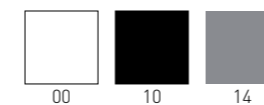

Laminated Top Color / Colore Piano Laminato



Special Finishes / Finiture Speciali

**Laminated:** Special Laminated Surfaces Wood Effect 25 (p. 122) available on demand (min. 20pcs each code).  
Special Laminated Surfaces Wood Effect 25 (p.122) disponibile su richiesta (min. 20pcs per codice).  
Special Laminated Surfaces Fenix 25 (p. 123) available on demand (min. 20pcs each code).  
Special Laminated Surfaces Fenix 25 (p.123) disponibile su richiesta (min. 20pcs per codice).

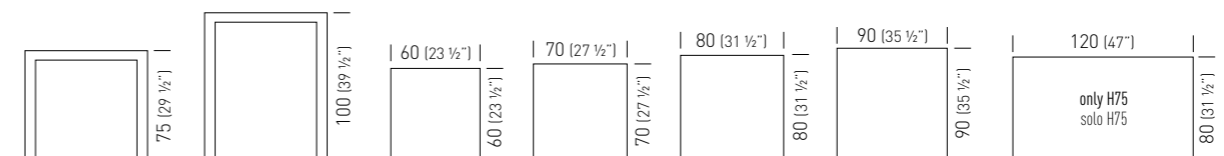

60x60	TSIML438._._/H75		0.28m³ / 16kg / 1pcs
60x60	TSIML438._._/H100		0.28m³ / 17kg / 1pcs
70x70	TSIML440._._/H75		0.28m³ / 17kg / 1pcs
70x70	TSIML440._._/H100		0.28m³ / 18kg / 1pcs
80x80	TSIML442._._/H75		0.40m³ / 18.5kg / 1pcs
80x80	TSIML442._._/H100		0.40m³ / 19.5kg / 1pcs
90x90	TSIML444._._/H75		0.40m³ / 21kg / 1pcs
90x90	TSIML444._._/H100		0.40m³ / 22kg / 1pcs
120x80	TSIML446._._/H75		0.40m³ / 23.5kg / 1pcs

# Hug

Studio Eurolinea Design



The Hug collection is characterized by the possibility of combine table tops in Compactop or Iron, which can also be used outdoors, or in Laminate, for the most specific indoor settings. The table is made with a 4-star aluminum base, equipped with adjustable feet, and aluminum column and cross.

La collezione Hug è caratterizzata dalla possibilità di poter abbinare piani tavoli in Compactop e Iron, utilizzabili anche all'esterno, o in Laminato per le più specifiche ambientazioni indoor. Il tavolo è realizzato con basamento 4 razze in alluminio, dotato di piedini regolabili, e da colonna e crociera in alluminio.



Frame Color / Colore Struttura

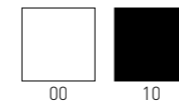

Special Finishes / Finiture Speciali

**Compactop:** Special Compactop Surfaces Fullcolor (p. 115) available on demand (min. 5pcs each code).  
Special Compactop Surfaces Fullcolor (p. 115) disponibile su richiesta (min. 5pcs per codice).  
Special Compactop Surfaces Fenix (p. 116) available on demand (min. 20pcs each code).  
Special Compactop Surfaces Fenix (p. 116) disponibile su richiesta (min. 20pcs per codice).  
Special Compactop Surfaces 10 (p. 118) available on demand (min. 20pcs each code).  
Special Compactop Surfaces 10 (p. 118) disponibile su richiesta (min. 20pcs per codice).

**Laminated:** Special Laminated Surfaces Wood Effect (p. 122) available on demand (min. 20pcs each code).  
Special Laminated Surfaces Wood Effect (p. 122) disponibile su richiesta (min. 20pcs per codice).  
Special Laminated Surfaces Fenix (p. 123) available on demand (min. 20pcs each code).  
Special Laminated Surfaces Fenix (p. 123) disponibile su richiesta (min. 20pcs per codice).

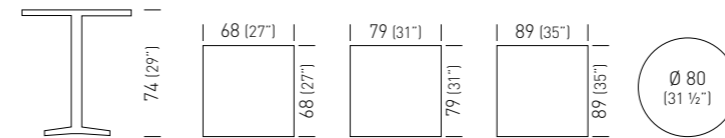

68x68compactop	THUGC200._._/H74		0.17m³ / 15.1kg / 1pcs
79x79compactop	THUGC204._._/H74		0.18m³ / 15.6kg / 1pcs
diam.80compactop	THUGC208._._/H74		0.18m³ / 15.1kg / 1pcs
89x89compactop	THUGC212._._/H74		0.20m³ / 18.1kg / 1pcs

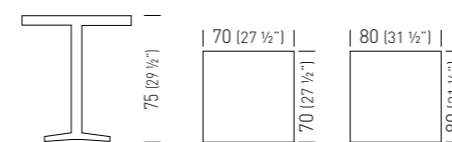

70x70 iron	THUGI217._._/H75		0.17m³ / 16.4kg / 1pcs
80x80 iron	THUGI218._._/H75		0.18m³ / 16.6kg / 1pcs

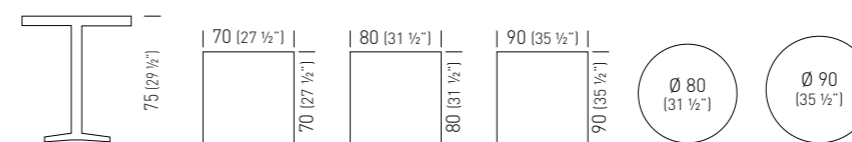



70x70laminated	THUGL220._._/H75		0.17m³ / 15.1kg / 1pcs
diam.80laminated	THUGL221._._/H75		0.18m³ / 12.6kg / 1pcs
80x80laminated	THUGL222._._/H75		0.18m³ / 17.6kg / 1pcs
diam.90laminated	THUGL223._._/H75		0.20m³ / 13.6kg / 1pcs
90x90laminated	THUGL224._._/H75		0.20m³ / 19.1kg / 1pcs



# Mug

Studio Eurolinea Design



CE   

230V - 50Hz  
1 X 16W - Led Modul  
IP 65



Technopolymer Base Color / Colore Base Tecnopolimero

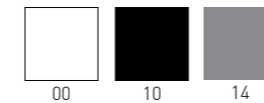

Led version with white transparent base.  
Versione led con base in bianco trasparente.



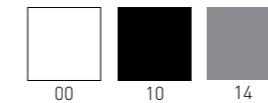



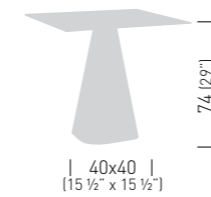

Compactop Color / Colore Piano Compactop



Special Finishes / Finiture Speciali

**Compactop:** Special Compactop Surfaces Fullcolor (p.115) white available on demand (min. 5pcs each code).  
Special Compactop Surfaces Fullcolor (p.115) bianco disponibile su richiesta (min. 5pcs per codice).



base74	base74+20	base74 Led	base74	base74+20	base74 Led	base74	base74+20	base74 Led
 Ø 60 (23 1/2)	diam.60	diam.60 Led	TMUGC170._____/H74	TMUGC170._____/H74L	TMUGC170._____/H74+20	0.21m³ / 18.0kg / 1pcs	0.21m³ / 20.2kg / 1pcs	0.21m³ / 38.0kg / 1pcs
 Ø 68 (27)	diam.68	diam.68 Led	TMUGC178._____/H74	TMUGC178._____/H74L	TMUGC178._____/H74+20	0.23m³ / 21.5kg / 1pcs	0.23m³ / 23.7kg / 1pcs	0.23m³ / 41.5kg / 1pcs
 Ø 80 (31 1/2)	diam.80	diam.80 Led	TMUGC186._____/H74	TMUGC186._____/H74L	TMUGC186._____/H74+20	0.5m³ / 23.5kg / 1pcs	0.5m³ / 25.7kg / 1pcs	0.5m³ / 43.5kg / 1pcs
 Ø 100 (39 1/2)	diam.100	diam.100 Led	TMUGC198._____/H74	TMUGC198._____/H74L	TMUGC198._____/H74+20	0.67m³ / 28.0kg / 1pcs	0.67m³ / 32.2kg / 1pcs	0.67m³ / 48.0kg / 1pcs
 60 (23 1/2)	60x60	60x60 Led	TMUGC174._____/H74	TMUGC174._____/H74L	TMUGC174._____/H74+20	0.21m³ / 20.0kg / 1pcs	0.21m³ / 22.5kg / 1pcs	0.21m³ / 39.5kg / 1pcs
 68 (27)	68x68	68x68 Led	TMUGC182._____/H74	TMUGC182._____/H74L	TMUGC182._____/H74+20	0.23m³ / 21.8kg / 1pcs	0.23m³ / 24.0kg / 1pcs	0.23m³ / 41.8kg / 1pcs
 79 (31)	79x79	79x79 Led	TMUGC190._____/H74	TMUGC190._____/H74L	TMUGC190._____/H74+20	0.50m³ / 25.0kg / 1pcs	0.50m³ / 27.0kg / 1pcs	0.50m³ / 45.0kg / 1pcs
 89 (35)	89x89	89x89 Led	TMUGC194._____/H74	TMUGC194._____/H74L	TMUGC194._____/H74+20	0.60m³ / 26.0kg / 1pcs	0.60m³ / 28.0kg / 1pcs	0.60m³ / 46.0kg / 1pcs

H75 Table with Compactop, Technopolymer base.  
Available illuminated and suitable for outdoor use.  
Tavolo realizzato con piano in Compactop H75  
e struttura in tecnopolimero.  
Disponibile con versione luminosa e adatti all'uso esterno.

# Roller

Studio Eurolinea Design



Tables, chairs, benches and stools Collection.  
Compactop with technopolymer bases.  
Available illuminated and suitable for outdoor use.  
Collezione di tavoli, sedute, panche e sgabelli.  
I tavoli sono realizzati con piano Compactop  
e struttura in tecnopolimero.  
Disponibili con versione luminosa  
e adatti anche all'uso esterno.



Technopolymer Base Color / Colore Base Tecnopolimero

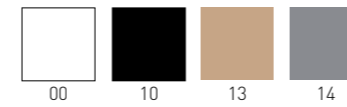

Compactop Color / Colore Piano Compactop

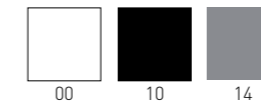

Special Finishes / Finiture Speciali

**Compactop:** Special Compactop Surfaces Fullcolor (p.115) white available on demand (min. 5pcs each code).  
Special Compactop Surfaces Fullcolor (p.115) bianco disponibile su richiesta (min. 5pcs per codice).

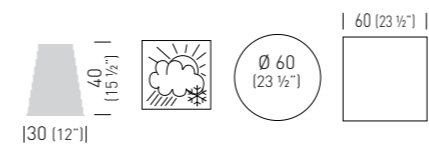

base	BROLLER._._-/H40	0.11m <sup>3</sup> / 2,5kg / 1pcs
diam.60	TROLC040._._-/H40	0.18m <sup>3</sup> / 8kg / 1pcs
60x60	TROLC044._._-/H40	0.18m <sup>3</sup> / 11,8kg / 1pcs



Technopolymer Base Color / Colore Base Tecnopolimero

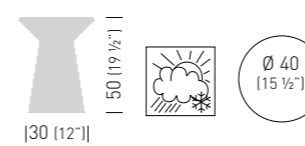
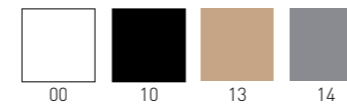

tavolino	244.--/A	0.1m <sup>3</sup> / 4kg / 1pcs
----------	----------	--------------------------------



# Roller

# R



CE   
 230V – 50Hz  
 1 X 16W – Led Modul  
 IP 65



CE   
 230V – 50Hz  
 1 X 16W – Led Modul  
 IP 65

**Technopolymer Base Color / Colore Base Tecnopolimero**

**Compact Color / Colore Piano Compacto**

**Special Finishes / Finiture Speciali**

**Compact:** Special Compact Surfaces Fullcolor (p.115) white available on demand (min. 5pcs each code). Special Compact Surfaces Fullcolor (p.115) bianco disponibile su richiesta (min. 5pcs per codice).

Led version with white transparent base.  
 Versione led con base in bianco trasparente.

**Technopolymer Base Color / Colore Base Tecnopolimero**

**Compact Color / Colore Piano Compacto**

**Special Finishes / Finiture Speciali**

**Compact:** Special Compact Surfaces Fullcolor (p.115) white available on demand (min. 5pcs each code). Special Compact Surfaces Fullcolor (p.115) bianco disponibile su richiesta (min. 5pcs per codice).

Led version with white transparent base.  
 Versione led con base in bianco trasparente.

base55	BROLLER._/H55	0.13m³ / 9.8kg / 1pcs
base55 Led	BROLLER._/H55L	0.13m³ / 13kg / 1pcs
Ø 60 [23 1/2"]	diam.60 diam.60 Led	TROLC040._./H55  0.21m³ / 15.5kg / 1pcs TROLC040._./H55L  0.21m³ / 18.8kg / 1pcs
Ø 68 [27"]	diam.68 diam.68 Led	TROLC048._./H55  0.23m³ / 19kg / 1pcs TROLC048._./H55L  0.23m³ / 22.2kg / 1pcs
60x60 [23 1/2"]	60x60 60x60 Led	TROLC044._./H55  0.21m³ / 17.5kg / 1pcs TROLC044._./H55L  0.21m³ / 20.7kg / 1pcs
68x68 [27"]	68x68 68x68 Led	TROLC052._./H55  0.23m³ / 20.5kg / 1pcs TROLC052._./H55L  0.23m³ / 23.7kg / 1pcs

base74	BROLLER._/H74	0.13m³ / 11.30kg / 1pcs
base74+20	BROLLER._/H74+20	0.13m³ / 31.30kg / 1pcs
base74 Led	BROLLER._/H74L	0.13m³ / 14.45kg / 1pcs
Ø 60 [23 1/2"]	diam.60 diam.60 Led	TROLC040._./H74  0.21m³ / 16.8kg / 1pcs TROLC040._./H74L  0.21m³ / 19.9kg / 1pcs
Ø 68 [27"]	diam.68 diam.68 Led	TROLC048._./H74  0.23m³ / 20.3kg / 1pcs TROLC048._./H74L  0.23m³ / 23.4kg / 1pcs
Ø 80 [31 1/2"]	diam.80 diam.80 Led	TROLC056._./H74  0.5m³ / 22.3kg / 1pcs TROLC056._./H74L  0.5m³ / 25.5kg / 1pcs
Ø 100 [39 1/2"]	diam.100 diam.100 Led	TROLC068._./H74  0.67m³ / 27kg / 1pcs TROLC068._./H74L  0.67m³ / 30kg / 1pcs
60x60 [23 1/2"]	60x60 60x60 Led	TROLC044._./H74  0.21m³ / 19.5kg / 1pcs TROLC044._./H74L  0.21m³ / 22.5kg / 1pcs
68x68 [27"]	68x68 68x68 Led	TROLC052._./H74  0.23m³ / 21.8kg / 1pcs TROLC052._./H74L  0.23m³ / 25kg / 1pcs
79x79 [31"]	79x79 79x79 Led	TROLC060._./H74  0.50m³ / 23.8kg / 1pcs TROLC060._./H74L  0.50m³ / 27kg / 1pcs
89x89 [35"]	89x89 89x89 Led	TROLC064._./H74  0.60m³ / 24.8kg / 1pcs TROLC064._./H74L  0.60m³ / 27.9kg / 1pcs



# Roller

# R



CE   
 230V - 50Hz  
 1 X 16W - Led Modul  
 IP 65

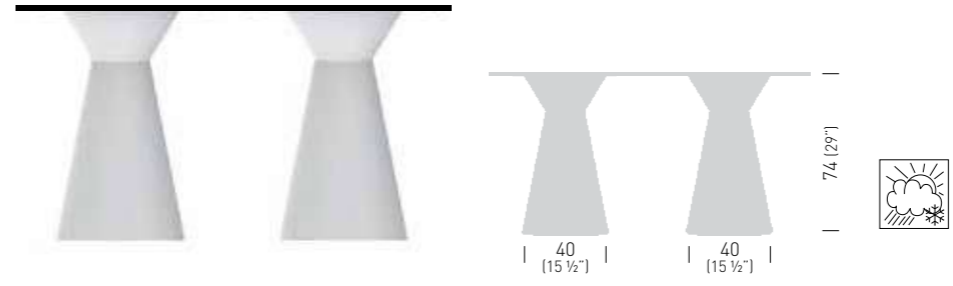

CE   
 230V - 50Hz  
 1 X 16W - Led Modul  
 IP 65

Technopolymer Base Color / Colore Base Tecnopolimero

Compactop Color / Colore Piano Compactop

Special Finishes / Finiture Speciali

**Compactop:** Special Compactop Surfaces Fullcolor (p.115) white available on demand (min. 5pcs each code).  
 Special Compactop Surfaces Fullcolor (p.115) bianco disponibile su richiesta (min. 5pcs per codice).

Led version with white transparent base.  
 Versione led con base in bianco trasparente.

Technopolymer Base Color / Colore Base Tecnopolimero

Compactop Color / Colore Piano Compactop

Special Finishes / Finiture Speciali

**Compactop:** Special Compactop Surfaces Fullcolor (p.115) white available on demand (min. 5pcs each code).  
 Special Compactop Surfaces Fullcolor (p.115) bianco disponibile su richiesta (min. 5pcs per codice).

Led version with white transparent base.  
 Versione led con base in bianco trasparente.

base110	BROLLER_/H110		0.2m <sup>3</sup> / 11.30kg / 1pcs
base110+20	BROLLER_/H110+20		0.2m <sup>3</sup> / 31.30kg / 1pcs
base110 Led	BROLLER_/H110L		0.2m <sup>3</sup> / 14.45kg / 1pcs
Ø 60 (23 1/2")	diam.60	TROLC040.__/H110	0.28m <sup>3</sup> / 20.6kg / 1pcs
	diam.60 Led	TROLC040.__/H110L	0.28m <sup>3</sup> / 23.8kg / 1pcs
Ø 68 (27")	diam.68	TROLC048.__/H110	0.31m <sup>3</sup> / 24.1kg / 1pcs
	diam.68 Led	TROLC048.__/H110L	0.31m <sup>3</sup> / 27.3kg / 1pcs
Ø 80 (31 1/2")	diam.80	TROLC056.__/H110	0.5m <sup>3</sup> / 26.1kg / 1pcs
	diam.80 Led	TROLC056.__/H110L	0.5m <sup>3</sup> / 29.3kg / 1pcs
60x60 (23 1/2")	60x60	TROLC044.__/H110	0.28m <sup>3</sup> / 22.8kg / 1pcs
	60x60 Led	TROLC044.__/H110L	0.28m <sup>3</sup> / 26kg / 1pcs
68x68 (27")	68x68	TROLC052.__/H110	0.31m <sup>3</sup> / 25.6kg / 1pcs
	68x68 Led	TROLC052.__/H110L	0.31m <sup>3</sup> / 28.8kg / 1pcs
79x79 (31")	79x79	TROLC060.__/H110	0.5m <sup>3</sup> / 27.6kg / 1pcs
	79x79 Led	TROLC060.__/H110L	0.5m <sup>3</sup> / 30.8kg / 1pcs

base74	BROLLER_/2H74		0.26m <sup>3</sup> / 22.60kg / 1pcs
120x50 (47")	TROLC072.__/2H74		0.56m <sup>3</sup> / 38.1kg / 1pcs
120x80 (47")	TROLC076.__/2H74		0.56m <sup>3</sup> / 39.1kg / 1pcs
140x70 (55")	TROLC080.__/2H74		0.66m <sup>3</sup> / 42.6kg / 1pcs
159x79 (62 1/2")	TROLC084.__/2H74		0.94m <sup>3</sup> / 45.6kg / 1pcs
base110	BROLLER_/2H110		0.38m <sup>3</sup> / 30.2kg / 1pcs
120x50 (47")	TROLC072.__/H110		0.66m <sup>3</sup> / 45.7kg / 1pcs
120x80 (47")	TROLC076.__/H110		0.66m <sup>3</sup> / 46.7kg / 1pcs
140x70 (55")	TROLC080.__/H110		0.84m <sup>3</sup> / 50.2kg / 1pcs
159x79 (62 1/2")	TROLC084.__/H110		1.04m <sup>3</sup> / 53.2kg / 1pcs

# Jackie

Studio Eurolinea Design



Top and Frame Color / Colore Piano e Struttura

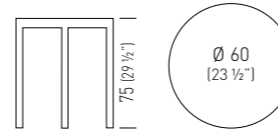
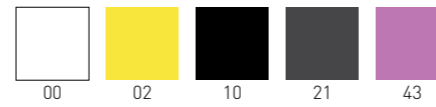

diam.60

TJAKI027.\_/H75

 0.41m³ / 14kg / 2pcs

Metal table top and stackable metal frame.  
Suitable for outdoor use.  
Tavolo impilabile con piano in metallo verniciato,  
adatto anche all'uso esterno.

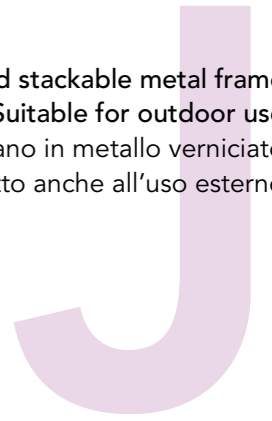

# Culture

Malene Flensted Urup Design



Frame Color / Colore Struttura



10



diam.50  
diam.70

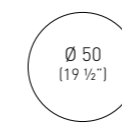

1500/NAN  
1501/NAN



0.20m³ / 10kg / 1pcs  
0.20m³ / 11kg / 1pcs

The Culture hanging planters, designed by Malene Flensted Urup, are an interesting system to bring what normally attracts the outdoors in, into workplace and hospitality settings. The Culture system easily creates oases of calm with a minimalist look: practical and good looking, simplifying the cleanliness and order of the most contemporary environments.

Available in two sizes, these planters have been created to be fixed to the ceiling, thus creating vertical gardens even in limited spaces areas.

Le fioriere pensili Culture, disegnate da Malene Flensted Urup, sono un'interessante sistema per portare ciò che normalmente richiama l'outdoor all'interno, in stanze dedicate all'ambiente di lavoro e all'ospitalità.

Il sistema Culture crea facilmente delle oasi di calma dal look minimalista: pratiche e piacevoli alla vista, semplificano la pulizia e l'ordine degli ambienti più contemporanei.

Disponibili in due dimensioni, le fioriere sono state create per essere fissate al soffitto e creare quindi giardini verticali anche in aree dove lo spazio è limitato.

TKITT is a table collection, suitable for outdoor use. Tables are made with techno polymer tops in different shapes and sizes, combined with technopolymer-metal co-injected bases and anodized columns.

Technopolymer table top colors match perfectly the colors of the Gaber seating collection.

TKITT è una collezione di tavoli adatti anche all'uso esterno. I tavoli sono realizzati con piani in tecnopolimero di varie dimensioni e forme, combinati a basamenti in metallo sovrastampato con tecnopolimero e colonne in alluminio anodizzato. I colori dei piani dei tavoli corrispondono ai colori della vasta collezione di sedute Gaber.

## TKITT Collection

TABLES FOR INDOOR AND OUT



# TKITT.BG3K

H75 Table with technopolymer top, BG3K 3-spur metal-technopolymer co-injected table base, Ø 80mm anodized aluminum column.

Tavolo con piano in tecnopolimero H75, basamento BG3K a tre razze in metallo sovrastampato con tecnopolimero, colonna in alluminio anodizzato Ø 80mm.

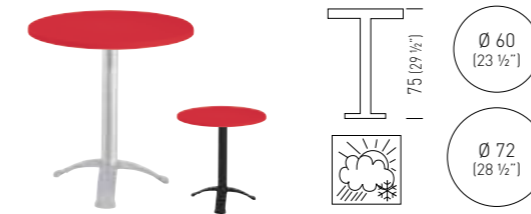

■ TKITT04.\_/BG3K 0.13m³ / 13.8kg / 1pcs  
 ■ TKITT04.\_/BG3K.10 0.13m³ / 13.8kg / 1pcs

■ TKITT03.\_/BG3K 0.15m³ / 14.5kg / 1pcs  
 ■ TKITT03.\_/BG3K.10 0.15m³ / 14.5kg / 1pcs



■ TKITT20.\_/BG3K 0.13m³ / 14.6kg / 1pcs  
 ■ TKITT20.\_/BG3K.10 0.13m³ / 14.6kg / 1pcs

■ TKITT06.\_/BG3K 0.15m³ / 15.8kg / 1pcs  
 ■ TKITT06.\_/BG3K.10 0.15m³ / 15.8kg / 1pcs

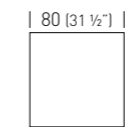

■ TKITT23.\_/BG3K 0.16m³ / 18.4kg / 1pcs  
 ■ TKITT23.\_/BG3K.10 0.16m³ / 18.4kg / 1pcs

Top Color / Colore Piano

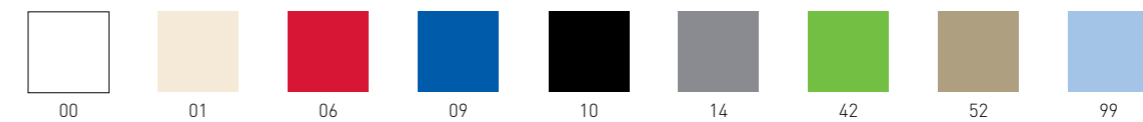



## TKITT.BG3L

H75 Table with technopolymer top, BG3L 3-spur metal-technopolymer co-injected table base, Ø 80mm anodized aluminum column.

Tavolo con piano in tecnopolimero H75, basamento BG3L a tre razze in metallo sovrastampato con tecnopolimero, colonna in alluminio anodizzato Ø 80mm.

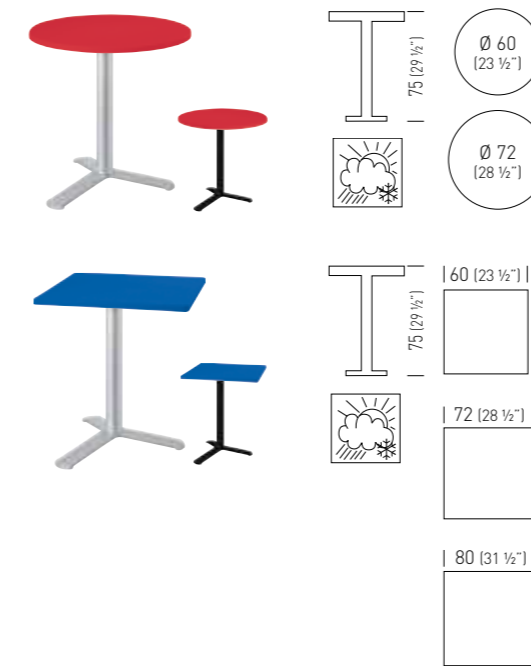

■ TKITT04.\_/BG3L 0.14m³ / 15kg / 1pcs  
 ■ TKITT04.\_/BG3L.10 0.14m³ / 15kg / 1pcs

■ TKITT03.\_/BG3L 0.16m³ / 15.7kg / 1pcs  
 ■ TKITT03.\_/BG3L.10 0.16m³ / 15.7kg / 1pcs

■ TKITT20.\_/BG3L 0.14m³ / 15.8kg / 1pcs  
 ■ TKITT20.\_/BG3L.10 0.14m³ / 15.8kg / 1pcs

■ TKITT06.\_/BG3L 0.16m³ / 17kg / 1pcs  
 ■ TKITT06.\_/BG3L.10 0.16m³ / 17kg / 1pcs

■ TKITT23.\_/BG3L 0.17m³ / 19.6kg / 1pcs  
 ■ TKITT23.\_/BG3L.10 0.17m³ / 19.6kg / 1pcs

## TKITT.BGA3L

H110 Table with technopolymer top, BG3L 3-spur metal-technopolymer co-injected table base, Ø 80mm anodized aluminum column.

Tavolo con piano in tecnopolimero H110, basamento BG3L a tre razze in metallo sovrastampato con tecnopolimero, colonna in alluminio anodizzato Ø 80mm.

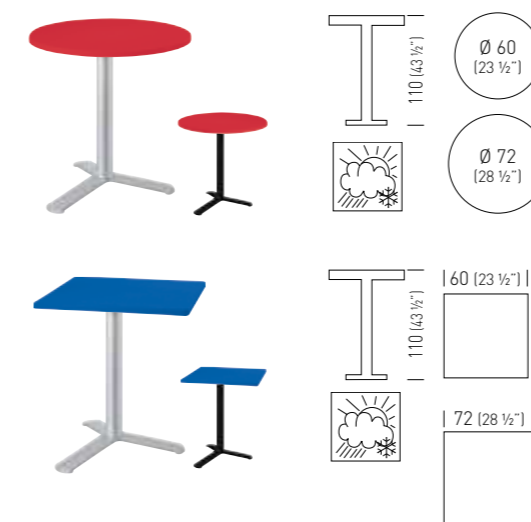

■ TKITT04.\_/BGA3L 0.18m³ / 15.8kg / 1pcs  
 ■ TKITT04.\_/BGA3L.10 0.18m³ / 15.8kg / 1pcs

■ TKITT03.\_/BGA3L 0.20m³ / 16.5kg / 1pcs  
 ■ TKITT03.\_/BGA3L.10 0.20m³ / 16.5kg / 1pcs

■ TKITT20.\_/BGA3L 0.18m³ / 16.6kg / 1pcs  
 ■ TKITT20.\_/BGA3L.10 0.18m³ / 16.6kg / 1pcs

■ TKITT06.\_/BGA3L 0.20m³ / 17.8kg / 1pcs  
 ■ TKITT06.\_/BGA3L.10 0.20m³ / 17.8kg / 1pcs

Top Color / Colore Piano



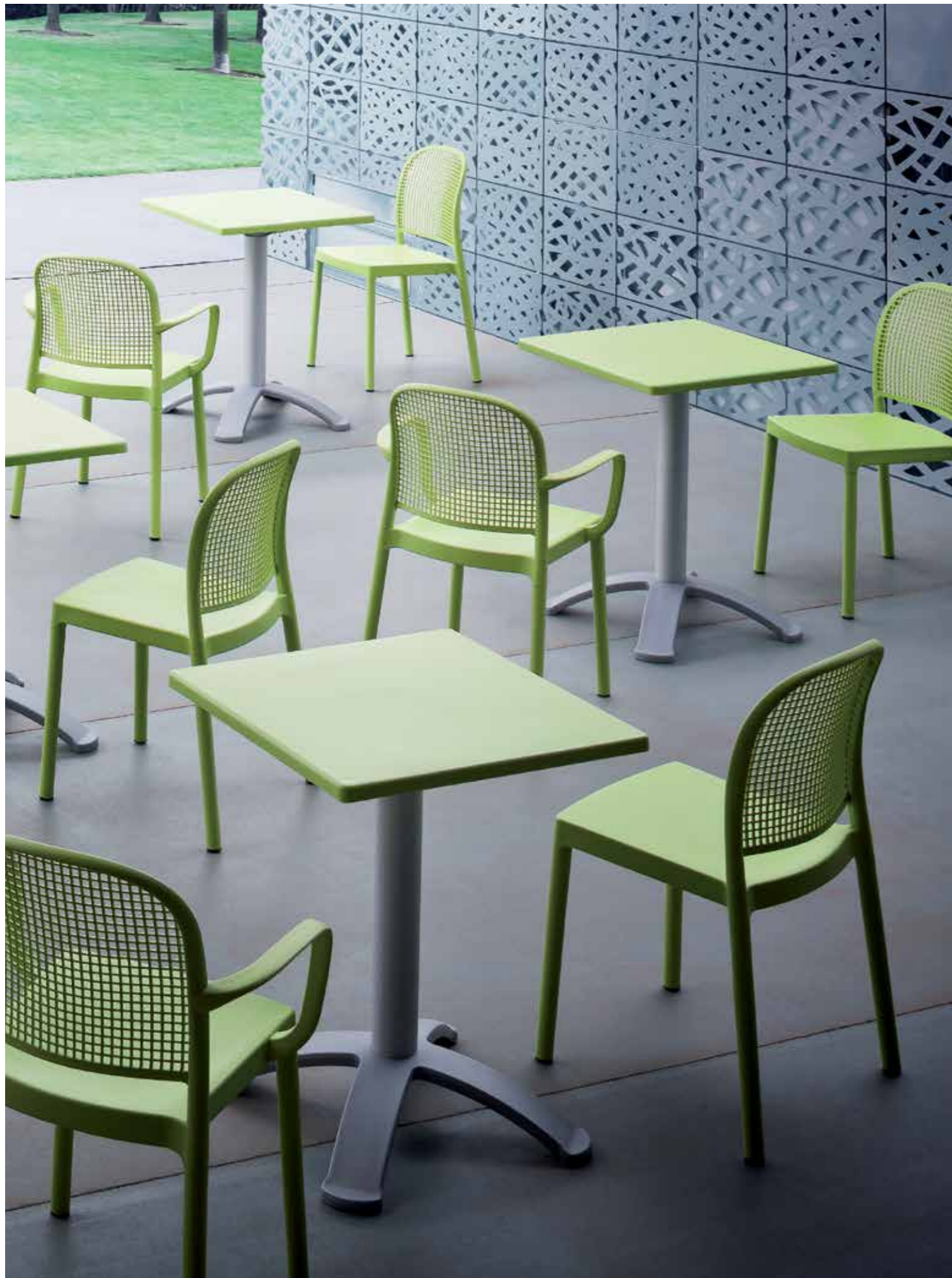

## TKITT.BG4K

H75 Table with technopolymer top, BG4K 4-spur metal-technopolymer co-injected table base, Ø 80mm anodized aluminum column.

Tavolo con piano in tecnopolimero H75, basamento BG4K a quattro razze in metallo sovrastampato con tecnopolimero, colonna in alluminio anodizzato Ø 80mm.

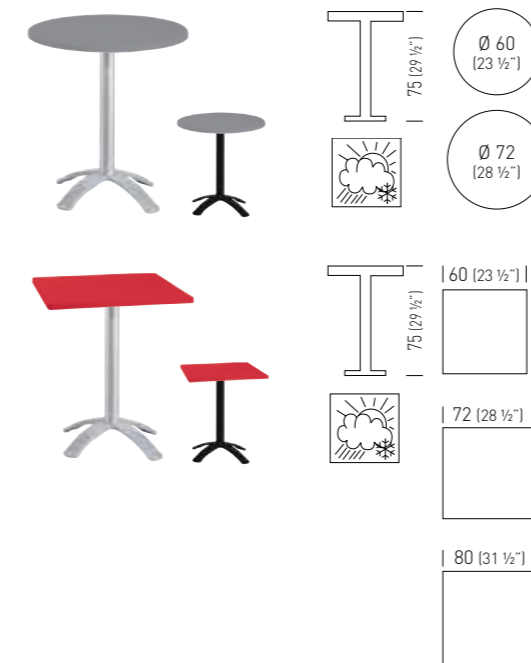

■ TKITT04.\_/BG4K 0.13m³ / 16.5kg / 1pcs  
 ■ TKITT04.\_/BG4K.10 0.13m³ / 16.5kg / 1pcs

■ TKITT03.\_/BG4K 0.15m³ / 17.2kg / 1pcs  
 ■ TKITT03.\_/BG4K.10 0.15m³ / 17.2kg / 1pcs

■ TKITT20.\_/BG4K 0.13m³ / 17.3kg / 1pcs  
 ■ TKITT20.\_/BG4K.10 0.13m³ / 17.3kg / 1pcs

■ TKITT06.\_/BG4K 0.15m³ / 18.5kg / 1pcs  
 ■ TKITT06.\_/BG4K.10 0.15m³ / 18.5kg / 1pcs

■ TKITT23.\_/BG4K 0.16m³ / 21.1kg / 1pcs  
 ■ TKITT23.\_/BG4K.10 0.16m³ / 21.1kg / 1pcs

## TKITT.BGA4K

H115 Table with technopolymer top, BG4K 4-spur metal-technopolymer co-injected table base, Ø 80mm anodized aluminum column.

Tavolo con piano in tecnopolimero H115, basamento BG4K a quattro razze in metallo sovrastampato con tecnopolimero, colonna in alluminio anodizzato Ø 80mm.



■ TKITT04.\_/BGA4K 0.17m³ / 17.3kg / 1pcs  
 ■ TKITT04.\_/BGA4K.10 0.17m³ / 17.3kg / 1pcs

■ TKITT03.\_/BGA4K 0.19m³ / 18kg / 1pcs  
 ■ TKITT03.\_/BGA4K.10 0.19m³ / 18kg / 1pcs

■ TKITT20.\_/BGA4K 0.17m³ / 18.1kg / 1pcs  
 ■ TKITT20.\_/BGA4K.10 0.17m³ / 18.1kg / 1pcs

■ TKITT06.\_/BGA4K 0.19m³ / 19.3kg / 1pcs  
 ■ TKITT06.\_/BGA4K.10 0.19m³ / 19.3kg / 1pcs

Top Color / Colore Piano

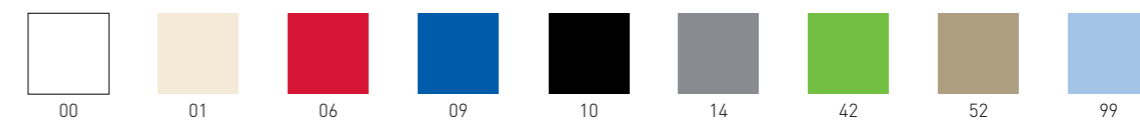

# TKITT.BG4J

H73 Table with technopolymer top, BG4J 4-spur metal-technopolymer co-injected table base, 80x80mm anodized aluminum column.

Tavolo con piano in tecnopolimero H73, basamento BG4J a quattro razze in metallo sovrastampato con tecnopolimero, colonna in alluminio anodizzato 80x80mm.

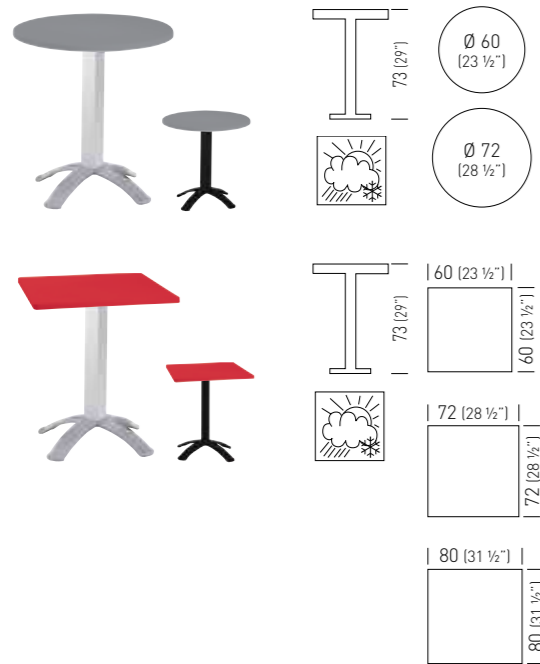

- TKITT04\_/BG4J 0.16m³ / 16.8kg / 1pcs
- TKITT04\_/BG4J.10 0.16m³ / 16.8kg / 1pcs
- TKITT03\_/BG4J 0.18m³ / 17.5kg / 1pcs
- TKITT03\_/BG4J.10 0.18m³ / 17.5kg / 1pcs
- TKITT20\_/BG4J 0.16m³ / 17.6kg / 1pcs
- TKITT20\_/BG4J.10 0.16m³ / 17.6kg / 1pcs
- TKITT06\_/BG4J 0.18m³ / 18.8kg / 1pcs
- TKITT06\_/BG4J.10 0.18m³ / 18.8kg / 1pcs
- TKITT23\_/BG4J 0.19m³ / 21.4kg / 1pcs
- TKITT23\_/BG4J.10 0.19m³ / 21.4kg / 1pcs

# TKITT.BGPJ

H75 folding table with technopolymer top, BG4J 4-spur metal-technopolymer co-injected base, 80x80mm anodized aluminum column with flip-top mechanism.

Tavolo pieghevole con piano in tecnopolimero H75, basamento BGPJ a quattro razze in metallo sovrastampato con tecnopolimero, colonna in alluminio anodizzato 80x80mm.

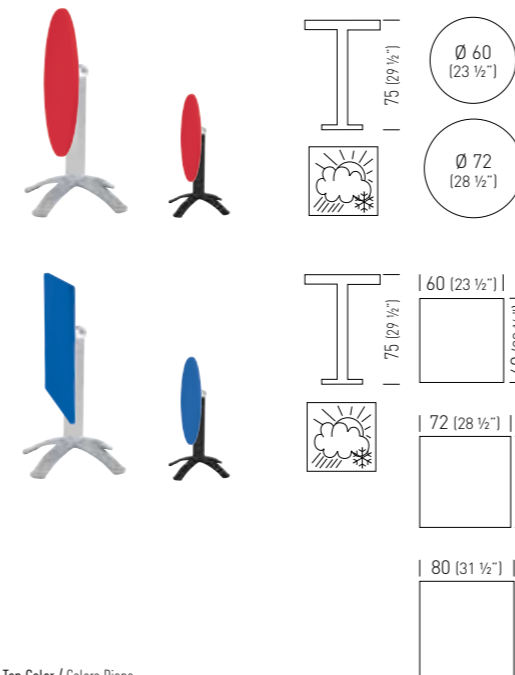

- TKITT04\_/BGPJ 0.16m³ / 17.8kg / 1pcs
- TKITT04\_/BGPJ.10 0.16m³ / 17.8kg / 1pcs
- TKITT03\_/BGPJ 0.18m³ / 18.5kg / 1pcs
- TKITT03\_/BGPJ.10 0.18m³ / 18.5kg / 1pcs
- TKITT20\_/BGPJ 0.16m³ / 18.6kg / 1pcs
- TKITT20\_/BGPJ.10 0.16m³ / 18.6kg / 1pcs
- TKITT06\_/BGPJ 0.18m³ / 19.8kg / 1pcs
- TKITT06\_/BGPJ.10 0.18m³ / 19.8kg / 1pcs
- TKITT23\_/BGPJ 0.19m³ / 22.4kg / 1pcs
- TKITT23\_/BGPJ.10 0.19m³ / 22.4kg / 1pcs

Top Color / Colore Piano

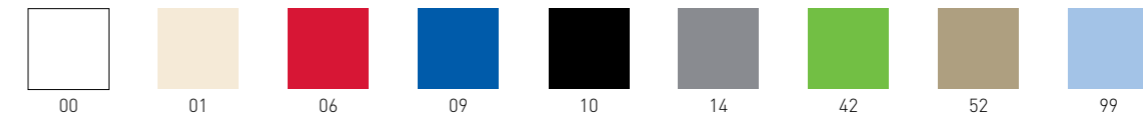

# TKITT.BGPK

H75 folding table with technopolymer top, BG4J 4-spur metal-technopolymer co-injected base, Ø 80mm anodized aluminum column with flip-top mechanism.

Tavolo pieghevole con piano in tecnopolimero H75, basamento BGPK a quattro razze in metallo sovrastampato con tecnopolimero, colonna in alluminio anodizzato Ø 80mm.

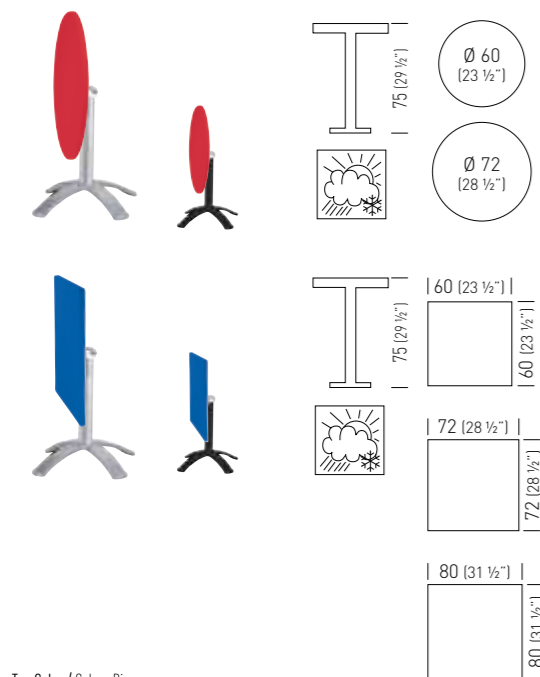

- TKITT04\_/BGPK 0.13m³ / 17.5kg / 1pcs
- TKITT04\_/BGPK.10 0.13m³ / 17.5kg / 1pcs
- TKITT03\_/BGPK 0.15m³ / 18.2kg / 1pcs
- TKITT03\_/BGPK.10 0.15m³ / 18.2kg / 1pcs
- TKITT20\_/BGPK 0.13m³ / 18.3kg / 1pcs
- TKITT20\_/BGPK.10 0.13m³ / 18.3kg / 1pcs
- TKITT06\_/BGPK 0.15m³ / 19.5kg / 1pcs
- TKITT06\_/BGPK.10 0.15m³ / 19.5kg / 1pcs
- TKITT23\_/BGPK 0.16m³ / 22.1kg / 1pcs
- TKITT23\_/BGPK.10 0.16m³ / 22.1kg / 1pcs

Top Color / Colore Piano

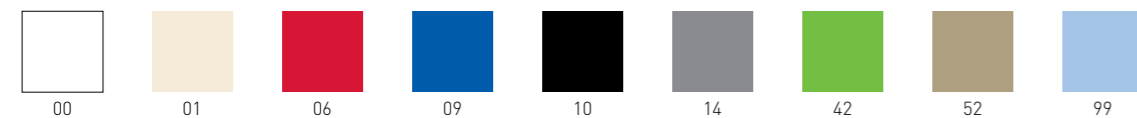





# TKITT.BG4IP

Folding and stacking H75 table with technopolymer top, BG4IP 4-spur metal-technopolymer co-injected table base, Ø 80mm anodized aluminum column with flip-top mechanism and adjustable feet.

Tavolo pieghevole e accatastabile con piano in tecnopolimero H75, basamento BG4IP a quattro razze in metallo sovrastampato con tecnopolimero, colonna in alluminio anodizzato Ø 80mm e piedini regolabili.

Top Color / Colore Piano	Product Code	Dimensions (m³ / kg / pcs)
00 (White)	TKITT04._/BG4IP	0.13m³ / 14kg / 1pcs
	TKITT04._/BG4IP.10	0.13m³ / 14kg / 1pcs
01 (Beige)	TKITT03._/BG4IP	0.15m³ / 14.7kg / 1pcs
	TKITT03._/BG4IP.10	0.15m³ / 14.7kg / 1pcs
06 (Red)	TKITT20._/BG4IP	0.13m³ / 14.8kg / 1pcs
	TKITT20._/BG4IP.10	0.13m³ / 14.8kg / 1pcs
09 (Blue)	TKITT06._/BG4IP	0.15m³ / 16kg / 1pcs
	TKITT06._/BG4IP.10	0.15m³ / 16kg / 1pcs
10 (Black)	TKITT23._/BG4IP	0.16m³ / 18.5kg / 1pcs
	TKITT23._/BG4IP.10	0.16m³ / 18.5kg / 1pcs
14 (Grey)	TKITT23._/BG4IP	0.16m³ / 18.5kg / 1pcs
	TKITT23._/BG4IP.10	0.16m³ / 18.5kg / 1pcs
42 (Green)	TKITT23._/BG4IP	0.16m³ / 18.5kg / 1pcs
	TKITT23._/BG4IP.10	0.16m³ / 18.5kg / 1pcs
52 (Brown)	TKITT23._/BG4IP	0.16m³ / 18.5kg / 1pcs
	TKITT23._/BG4IP.10	0.16m³ / 18.5kg / 1pcs
99 (Light Blue)	TKITT23._/BG4IP	0.16m³ / 18.5kg / 1pcs
	TKITT23._/BG4IP.10	0.16m³ / 18.5kg / 1pcs



## TKITT.BTK

H75 Table with technopolymer top, round BTK metal-technopolymer co-injected base, Ø 80mm anodized aluminum column.

Tavolo con piano in tecnopolimero H75, basamento BTK rotondo in metallo sovrastampato con tecnopolimero, colonna in alluminio anodizzato Ø 80mm.

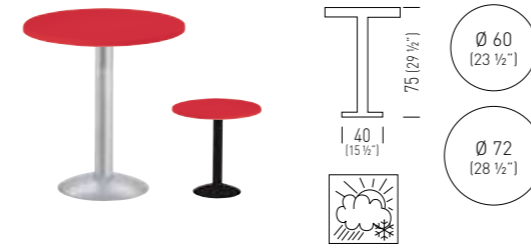

■ TKITT04._/BTK	0.16m³ / 13.8kg / 1pcs
■ TKITT04._/BTK.10	0.16m³ / 13.8kg / 1pcs
■ TKITT03._/BTK	0.18m³ / 14.5kg / 1pcs
■ TKITT03._/BTK.10	0.18m³ / 14.5kg / 1pcs

## TKITT.BTAK

H110 Table with technopolymer top, round BTAK metal-technopolymer co-injected base, Ø 80mm anodized aluminum column.

Tavolo con piano in tecnopolimero H110, basamento BTAK rotondo in metallo sovrastampato con tecnopolimero, colonna in alluminio anodizzato Ø 80mm.

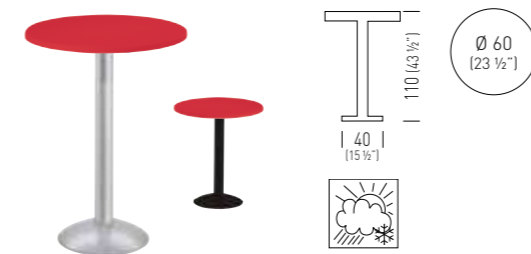

■ TKITT04._/BTAK	0.17m³ / 14.8kg / 1pcs
■ TKITT04._/BTAK.10	0.17m³ / 14.8kg / 1pcs

Top Color / Colore Piano





## TKITT.BTK54

H75 Table with technopolymer top, round BTK54 metal-technopolymer co-injected table base, Ø 80mm anodized aluminum column.

Tavolo con piano in tecnopolimero H75, basamento BTK54 rotondo in metallo sovrastampato con tecnopolimero, colonna in alluminio anodizzato Ø 80mm.

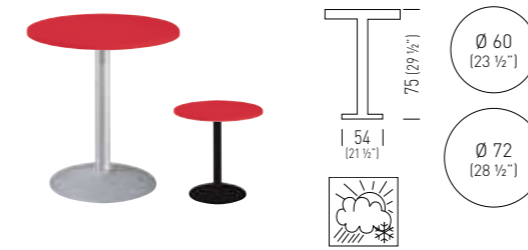

■ TKITT04._/BTK54		0.16m³ / 16.3kg / 1pcs
■ TKITT04._/BTK54.10		0.16m³ / 16.3kg / 1pcs
■ TKITT03._/BTK54		0.18m³ / 17kg / 1pcs
■ TKITT03._/BTK54.10		0.18m³ / 17kg / 1pcs

## TKITT.BTAK54

H110 Table with technopolymer top, round BTK54 metal-technopolymer co-injected table base, Ø 80mm anodized aluminum column.

Tavolo con piano in tecnopolimero H110, basamento BTAK54 rotondo in metallo sovrastampato con tecnopolimero, colonna in alluminio anodizzato Ø 80mm.

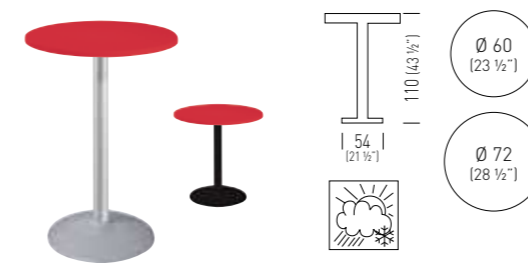

■ TKITT04._/BTAK54		0.17m³ / 17.3kg / 1pcs
■ TKITT04._/BTAK54.10		0.17m³ / 17.3kg / 1pcs
■ TKITT03._/BTAK54		0.19m³ / 18kg / 1pcs
■ TKITT03._/BTAK54.10		0.19m³ / 18kg / 1pcs

Top Color / Colore Piano





## TKITT.DPBT54

H110 double table with technopolymer tops, round DPBT54 metal-technopolymer co-injected base, Ø 80mm anodized aluminum column.

Tavolo con doppio piano in tecnopolimero H110, basamento DPBT54 rotondo in metallo sovrastampato con tecnopolimero, colonna in alluminio anodizzato Ø 80mm.



- TKITT08./DPBT54  0.15m³ / 16.5kg / 1pcs
- TKITT08./DPBT54.10  0.15m³ / 16.5kg / 1pcs

Top Color / Colore Piano

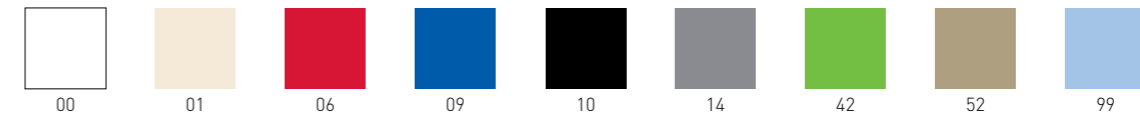



# TKITT.BRK

H75 Table with technopolymer top, round BRK metal-technopolymer co-injected base, Ø 80mm anodized aluminum column.

Tavolo con piano in tecnopolimero H75, basamento BRK rotondo in metallo sovrastampato con tecnopolimero, colonna in alluminio anodizzato Ø 80mm.

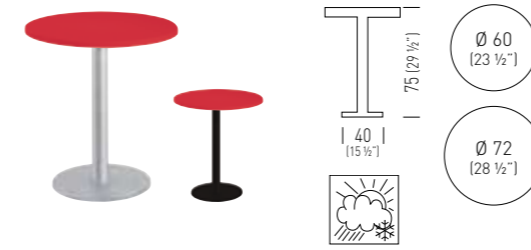

■ TKITT04._/BRK	0.13m³ / 14.3kg / 1pcs
■ TKITT04._/BRK.10	0.13m³ / 14.3kg / 1pcs
■ TKITT03._/BRK	0.15m³ / 15kg / 1pcs
■ TKITT03._/BRK.10	0.15m³ / 15kg / 1pcs

Top Color / Colore Piano





## TKITT.BQJ

H74 Table with technopolymer top, square BQJ metal-technopolymer co-injected table base, 80x80mm anodized aluminum column.

Tavolo con piano in tecnopolimero H74, basamento BQJ quadrato in metallo sovrastampato con tecnopolimero, colonna in alluminio anodizzato 80x80mm.

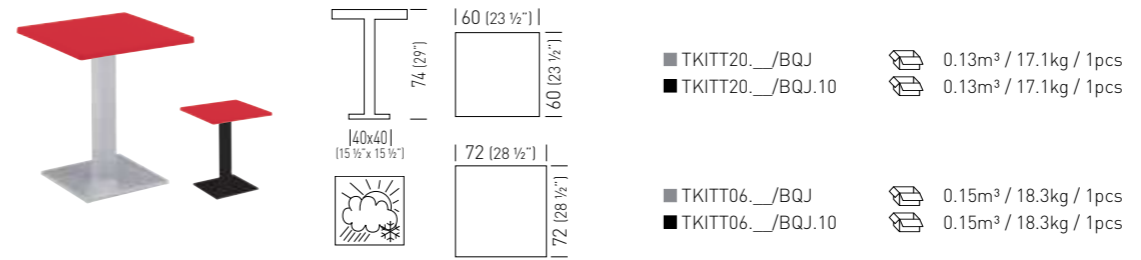

## TKITT.BQAJ

H103 Table with technopolymer top, square BQJ metal-technopolymer co-injected table base, 80x80mm anodized aluminum column.

Tavolo con piano in tecnopolimero H103, basamento BQJ quadrato in metallo sovrastampato con tecnopolimero, colonna in alluminio anodizzato 80x80mm.

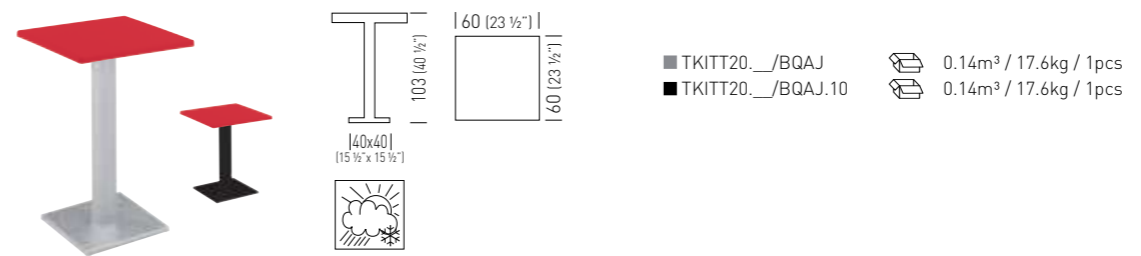

Top Color / Colore Piano





# TIMPT.STAKY

Stackable table collection, suitable for outdoor use.  
Techno polymer tops and anodized aluminum frames.

Collezione di tavoli impilabili, adatti all'uso esterno.  
I tavoli sono realizzati con piani in tecnopolimero e struttura in alluminio anodizzato.



Top Color / Colore Piano





# TCONT.STEADY

Counterbalanced tables collection, suitable for outdoor use.  
Techno polymer tops and anodized aluminum frames.

Collezione di tavoli a contrappesi, adatti all'uso esterno.  
I tavoli sono realizzati con piani in tecnopolimero e struttura in alluminio anodizzato.



TCONT06.\_/H75

0.08m³ / 12.8kg / 1pcs



TCONT23.\_/H75

0.10m³ / 13kg / 1pcs



TCONT03.\_/H75

0.08m³ / 12.6kg / 1pcs

Top Color / Colore Piano





TABLE TOPS  
**Collection**





# Special Compactop Surfaces

## 10



Flat black edge  
Bordo piatto nero

10 mm  
(0.39")

(min. 20pcs each code)  
(min. 20pcs per codice)

Solid

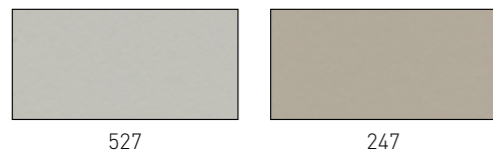

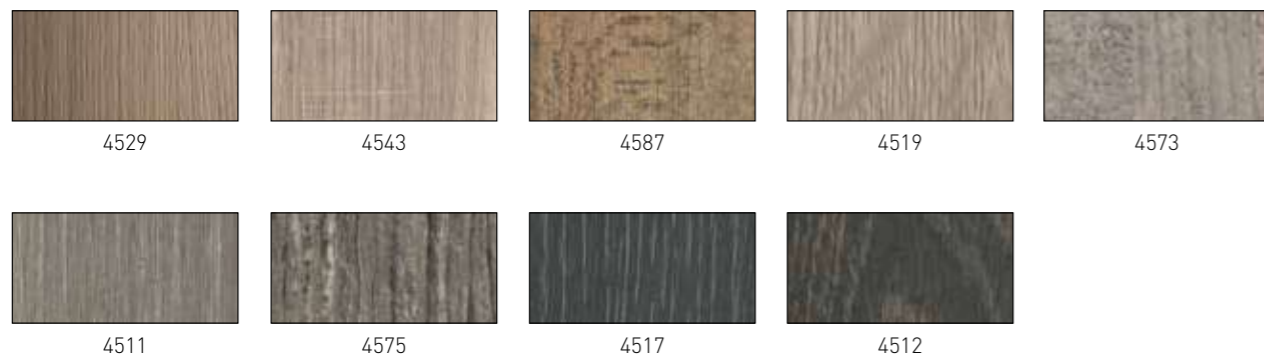

Wood effect



Stone, Concrete, Corten and Marble effect



	Sizes / Misure	Code / Codice	
	Ø 60 (23 1/2")	PTC501. __	0.700m <sup>3</sup> / 95kg / 20pcs
	Ø 68 (27")	PTC503. __	0.700m <sup>3</sup> / 120kg / 20pcs
	59x59 (23"x23")	PTC502. __	0.700m <sup>3</sup> / 115kg / 20pcs
	68x68 (27"x27")	PTC504. __	0.700m <sup>3</sup> / 155kg / 20pcs
	79x79 (31"x31")	PTC506. __	0.840m <sup>3</sup> / 195kg / 20pcs
	89x89 (35"x35")	PTC507. __	0.840m <sup>3</sup> / 245kg / 20pcs

### ABOUT COMPACTOP: MUCH MORE THAN A MERE SURFACE

Gaber Compactops are made of high-pressure laminate, consisting of numerous layers of paper saturated with thermosetting resins and bonded through the combined action of heat and high pressure. The paper used on Compactop (around 70% of the complete composition) comes from production processes that conform with the FSC chain of custody; phenolic and melamine resins are all strictly water-based.

The result is a stable, non-reactive, homogenous, non-porous, antistatic, high-density product with a totally distinct physical and chemical profile from that of its constituent parts. Thanks to the heat and high-pressure treatment it they undergo, Gaber Compactops are exceptionally tough and resistant to scratches, abrasions, chemicals and heat, making them ideal for a wide range of contract applications. Tops come pre-bored for Gaber kit bases.

Gaber Compactops conform to EN 438/1. According to this norm, the most important characteristics of Gaber Compactops are: their resistance to bumps, scratches, and wear and tear; color-fastness; easy cleanability; suitable for contact with food and general hygiene.

### MAINTENANCE & CLEANING

No specific maintenance other than normal cleaning is required. The compact, non porous surface can easily be cleaned and disinfected with hot water, steam and any common non-abrasive household detergents and disinfectants, as long as these are not highly alkaline. Just a couple of precautions are necessary: avoid using strong acids and bases and avoid wiping with highly abrasive substances or equipment.

### CHE COS'È IL COMPACTOP? MOLTO PIÙ DI UNA SEMPLICE SUPERFICIE

Il Compactop che Gaber utilizza per i propri tavoli è un laminato realizzato ad alta pressione, costituito da numerosi strati di carta impregnati con resine termoindurenti fenoliche e melaminiche, compattati attraverso l'azione combinata di calore ed alta pressione. Le carte utilizzate (circa il 70% della composizione dei piani) derivano da processi che seguono il protocollo della catena di custodia certificata FSC; le resine fenoliche e melaminiche sono tutte rigorosamente realizzate su base acquosa.

Il risultato è un prodotto stabile, non reattivo, omogeneo, non poroso, antistatico e di alta densità. Grazie al trattamento di alta temperatura e pressione cui è sottoposto, il Compactop è un materiale estremamente robusto: resistente a graffi, urti, abrasioni, sostanze chimiche e calore; caratteristiche che lo rendono il materiale ideale per una vasta gamma di applicazioni. I fissaggi dei piani Compactop sono già predisposti per i basamenti Gaber.

Il Compactop è conforme alla norma EN 438/1, secondo la quale, queste sono le principali caratteristiche di qualità di questo materiale: Resistente all'impatto, ai graffi e all'usura, stabile alla luce, facile da pulire, igienico, adatto al contatto con i cibi.

### MANUTENZIONE E PULIZIA

Il Compactop non richiede alcuna manutenzione particolare al di là della normale pulizia.



La sua superficie compatta e non porosa può essere facilmente pulita e disinfettata con acqua calda, vapore e tutti i tipi dei più comuni detergenti e disinfettanti per uso domestico, purché non alcalini. Sono necessarie solo poche precauzioni, quali l'evitare l'uso di acidi o basi forti, evitare di strofinare con sostanze o strumenti fortemente abrasivi.



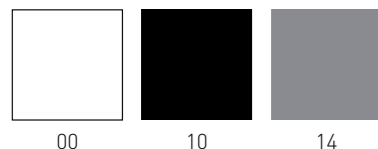

# Iron Surfaces



	Sizes / Misure	Code / Codice	
	60x60 (23 1/2" X 23 1/2")	PTI102_	0.054m <sup>3</sup> / 16.4kg / 2pcs
	70x70 (27 1/2" X 27 1/2")	PTI104_	0.074m <sup>3</sup> / 21.6kg / 2pcs
	80x80 (31 1/2" X 31 1/2")	PTI106_	0.090m <sup>3</sup> / 22kg / 2pcs
	120x80 (47" X 31 1/2")	PTI112_	0.20m <sup>3</sup> / 31.2kg / 2pcs

## ABOUT IRON TABLE TOPS

Gaber's Iron table tops are made of composite materials: a non-deformable water-repellent multilayer wood-based core, covered in steel. The slim line result is elegant, stylish and practical. Iron tops come pre-bored for Gaber kit bases. These tough materials make iron tops suitable for indoor as well as outdoor use.

## MAINTENANCE & CLEANING

Gaber's Iron table tops do not require any special maintenance beyond normal cleaning.

Its surface can be easily cleaned with a soft cloth dampened with water, even with household cleaning detergent, provided they are not alkaline and generally aggressive. Avoid the use of strong acids or bases, avoid rubbing with abrasive substances or devices.

## COSA SONO I PIANI DEI TAVOLI IRON?

I sistemi Iron che Gaber utilizza per i propri piani dei tavoli sono realizzati da materiali compositi: il cuore del sistema è realizzato con un materiale multistrato, a base legnosa, resistente all'umidità, di grande stabilità. Il rivestimento in acciaio e lo spessore contenuto rendono il prodotto elegante, raffinato e pratico. I fissaggi dei piani Iron sono già predisposti per i basamenti Gaber. Le finiture disponibili lo rendono adatto anche all'uso per outdoor, grazie all'ottimale resistenza agli agenti atmosferici.



## MANUTENZIONE E PULIZIA

I piani Iron di Gaber non richiedono alcuna manutenzione particolare al di là della normale pulizia.

La sua superficie può essere facilmente pulita con un panno morbido imbevuto di acqua, anche con detersivi per uso domestico, purché non alcalini ed in genere aggressivi. Evitare l'uso di acidi o basi forti, evitare di strofinare con sostanze o strumenti abrasivi.

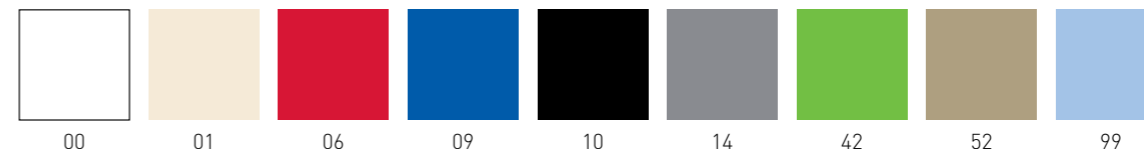
# Techno Polymer Table Tops



	Sizes / Misure	Code / Codice	
	Ø 60 (23 1/2")	PTT04_	0.054m <sup>3</sup> / 4kg / 1pcs
	Ø 72 (28 1/2")	PTT03_	0.074m <sup>3</sup> / 4.7kg / 1pcs
	60x60 (23 1/2" X 23 1/2")	PTT20_	0.054m <sup>3</sup> / 4.8kg / 1pcs
	72x72 (28 1/2" X 28 1/2")	PTT06_	0.074m <sup>3</sup> / 6kg / 1pcs
	80x80 (31 1/2" X 31 1/2")w	PTT23_	0.090m <sup>3</sup> / 8.6kg / 1pcs

## ABOUT TECHNO POLYMER TABLE-TOPS

The Techno Polymer Compounds Gaber uses on its table tops have high structural, heat and abrasion resistance. Gaber's technopolymer table tops are practical, shock-resistant, colorful and inexpensive.

Gaber technopolymers are non-toxic, stain-resistant, antistatic and UV-resistant and consequently have excellent resistance to atmospheric agents. All these materials are recyclable in the full respect of our Natural Environment. Gaber produces plastic injected materials without added chemicals and, as far as possible, recycled pre-used technopolymers are sourced as a base raw material. Technopolymer table top colors perfectly match the colors of Gaber's seating collection.

## MAINTENANCE & CLEANING

The plastic surfaces of Gaber products can generally be cleaned with a cloth and warm water. For the most persistent stains, a small amount of liquid soap diluted in water may be used. Do not use acetone, trichloroethylene, ammonia, alcoholic substances and detergents that contain even just a small amount of these substances. We also recommend avoiding all types of abrasive and solvent substances or rough sponges.

## COME SONO FATTI I RIPIANI IN TECNOPOLIMERO?

I piani in Tecnopolimero utilizzati da Gaber per i propri tavoli sono realizzati per mezzo del processo di iniezione plastica. I piani così realizzati sono pratici, resistenti agli urti, colorati ed economici. I compound di tecnopolimeri utilizzati da Gaber nella realizzazione dei propri prodotti sono caratterizzati da un'elevata resistenza strutturale, termica e all'abrasione. Il tecnopolimero è atossico, antimacchia, antistatico e anti-uv: qualità che lo rendono ottimamente resistente agli agenti atmosferici. I tecnopolimeri utilizzati da Gaber sono integralmente riciclabili, nel pieno rispetto del nostro Ambiente Naturale. Gaber produce articoli termoplastici senza additivi chimici e, ove possibile, vengono utilizzati tecnopolimeri riciclati derivanti da post-consumo. I colori dei ripiani dei tavoli corrispondono ai colori della vasta collezione di sedute Gaber.

## MANUTENZIONE E PULIZIA

Le superfici in tecno polimero dei piani dei tavoli Gaber possono essere pulite con un panno umido e soffice imbevuto in acqua. Per le macchie più ostinate è possibile diluire in acqua del sapone neutro liquido con moderazione. Non utilizzare acetone, trielina, ammoniacca, sostanze alcoliche o detersivi che contengano anche piccole quantità di tali detersivi. Non utilizzare a contatto con il prodotto sostanze abrasive o solventi, strumenti di pulizia ruvidi.

TABLE BASES  
**Collection**





## ARKET 3 BASE

H49-H73-H109 3 spur aluminum casted base, column made in aluminum extruded tube, aluminum cross and adjustable feet. Basamento per tavolo H49-H73-H109 con 3 razze e crociera in alluminio pressofuso, colonna in alluminio estruso. Piedini regolabili.

Top max dimensions / Massima dimensione piano

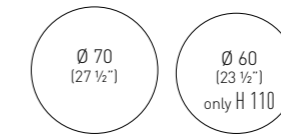

Available table tops / Piani tavolo disponibili

compactop laminated

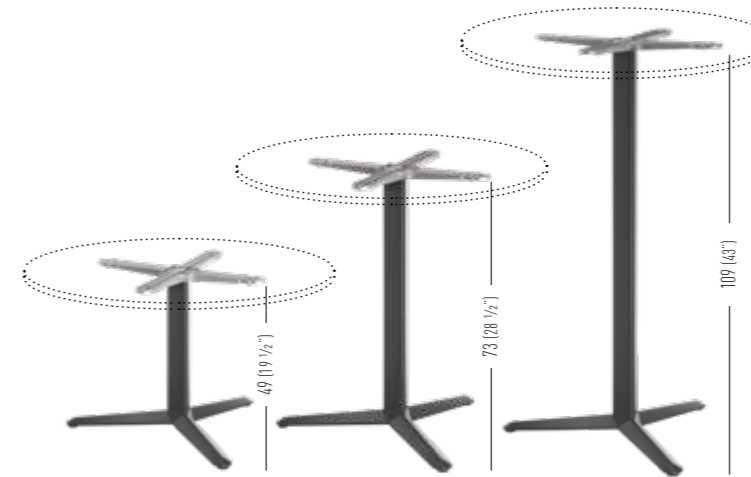

Frame Color / Colore Struttura

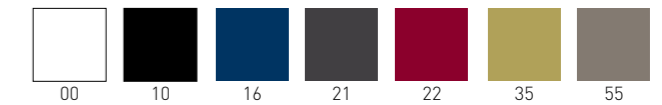

H49	BAK3B_		0.055m³ / 3.5kg / 1pcs
H73	BAK3_		0.055m³ / 4.0kg / 1pcs
H109	BAK3A_		0.085m³ / 4.2kg / 1pcs

## ARKET 4 BASE

H49-H73-H109 4 spur aluminum casted base, column made in aluminum extruded tube, aluminum cross and adjustable feet. Basamento per tavolo H49-H73-H109 con 4 razze e crociera in alluminio pressofuso, colonna in alluminio estruso. Piedini regolabili.

Top max dimensions / Massima dimensione piano

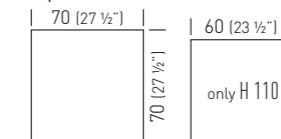

Available table tops / Piani tavolo disponibili

compactop laminated

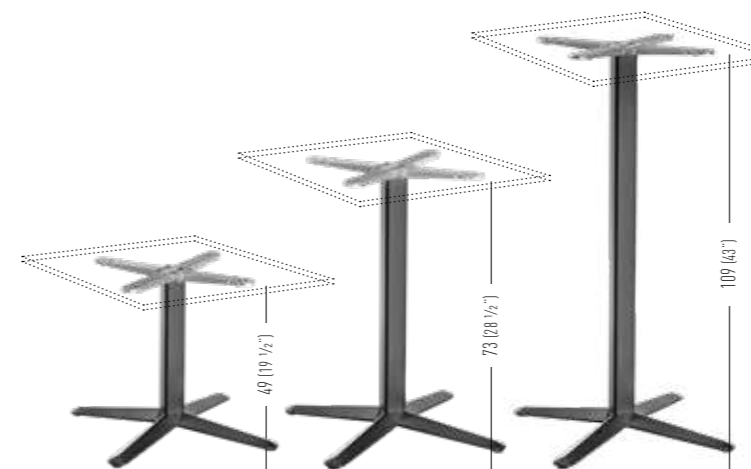

Frame Color / Colore Struttura



H49	BAK4B_		0.055m³ / 4.2kg / 1pcs
H73	BAK4_		0.055m³ / 4.5kg / 1pcs
H109	BAK4A_		0.085m³ / 4.8kg / 1pcs



## BG3K

H73 3-spur metal-technopolymer co-injected table base, Ø 80mm anodized aluminum column with cross.  
 Base per tavolo H73 a tre razze in metallo sovrastampato con tecnopolimero, colonna in alluminio anodizzato Ø 80mm, crociera.

Top max dimensions / Massima dimensione piano

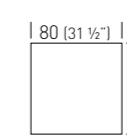

Available table tops / Piani tavolo disponibili

compactop  
laminated  
iron

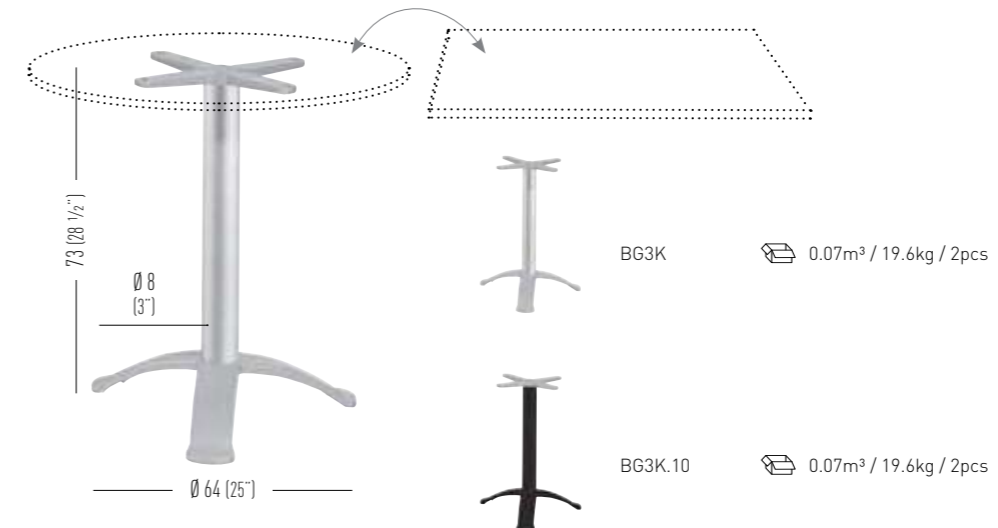

## BGA3K

H115 3-spur metal-technopolymer co-injected table base, Ø 80mm anodized aluminum column with cross.  
 Base per tavolo H115 a tre razze in metallo sovrastampato con tecnopolimero, colonna in alluminio anodizzato Ø 80mm, crociera.

Top max dimensions / Massima dimensione piano

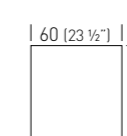

Available table tops / Piani tavolo disponibili

compactop  
laminated  
iron

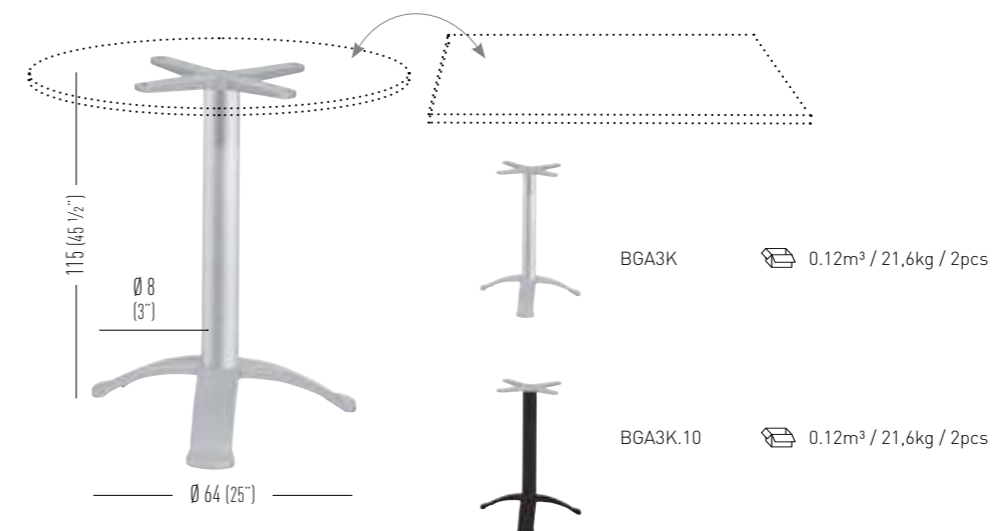



# BPG3K

H73 3-spur metal-technopolymer co-injected table base, Ø 60mm anodized aluminum column with cross.  
 Base per tavolo H73 a tre razze in metallo sovrastampato con tecnopolimero, colonna in alluminio anodizzato Ø 60mm, crociera.

Top max dimensions / Massima dimensione piano

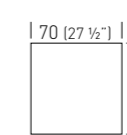

Available table tops / Piani tavolo disponibili

compactop  
laminated  
iron

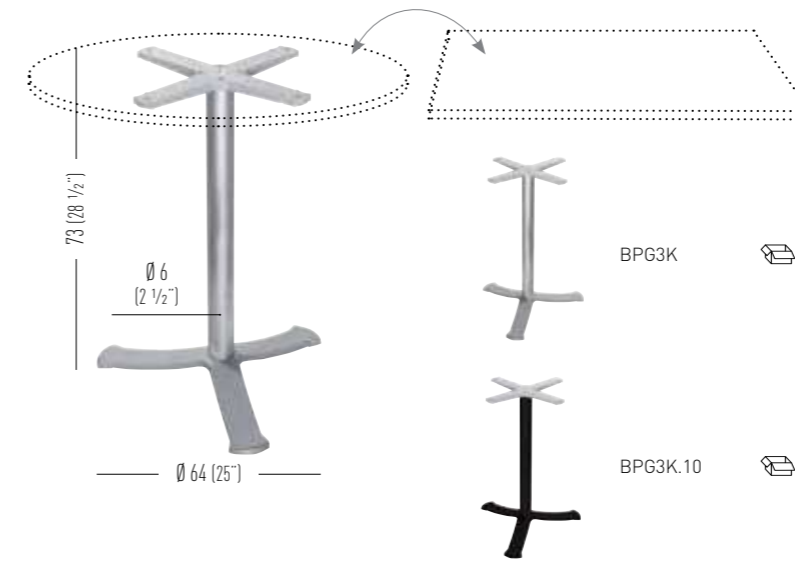

BPG3K 0.07m³ / 14.20kg / 2pcs

BPG3K.10 0.07m³ / 14.20kg / 2pcs



## BG3L

H73 3-spur metal-technopolymer co-injected table base, Ø 80mm anodized aluminum column with cross.  
 Base per tavolo H73 a tre razze in metallo sovrastampato con tecnopolimero, colonna in alluminio anodizzato Ø 80mm, crociera.

Top max dimensions / Massima dimensione piano

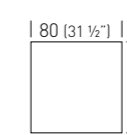
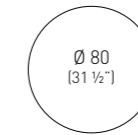

Available table tops / Piani tavolo disponibili

compactop  
laminated  
iron

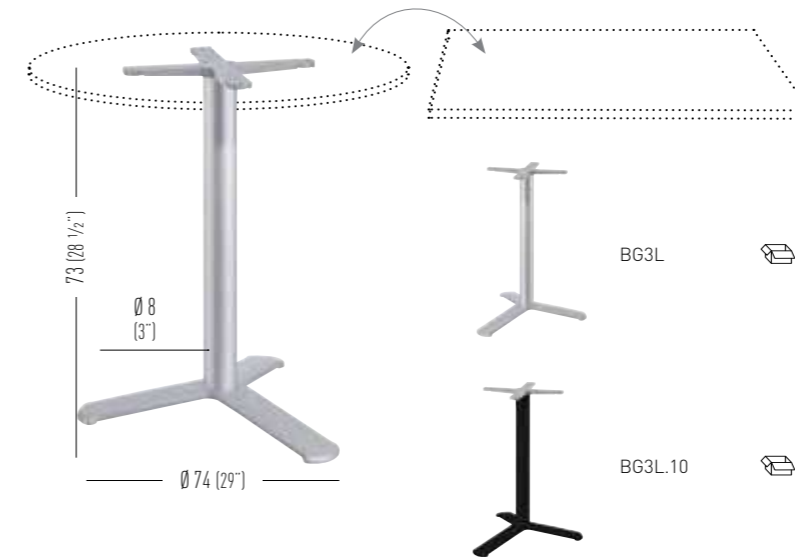

## BGA3L

H110 3-spur metal-technopolymer co-injected table base, Ø 80mm anodized aluminum column with cross.  
 Base per tavolo H110 a tre razze in metallo sovrastampato con tecnopolimero, colonna in alluminio anodizzato Ø 80mm, crociera.

Top max dimensions / Massima dimensione piano

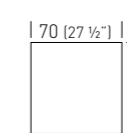
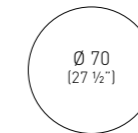

Available table tops / Piani tavolo disponibili

compactop  
laminated  
iron

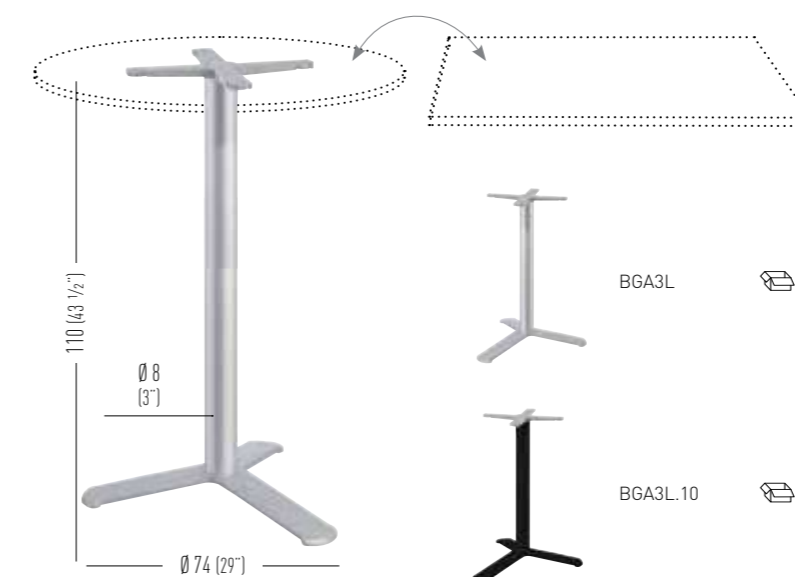



## BG4K

H73 4-spur metal-technopolymer co-injected table base, Ø 80mm anodized aluminum column with cross.  
Base per tavolo H73 a quattro razze in metallo sovrastampato con tecnopolimero, colonna in alluminio anodizzato Ø 80mm, crociera.

Top max dimensions / Massima dimensione piano

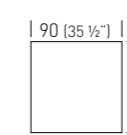
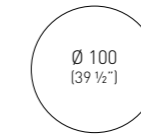

Available table tops / Piani tavolo disponibili

compactop  
laminated  
iron

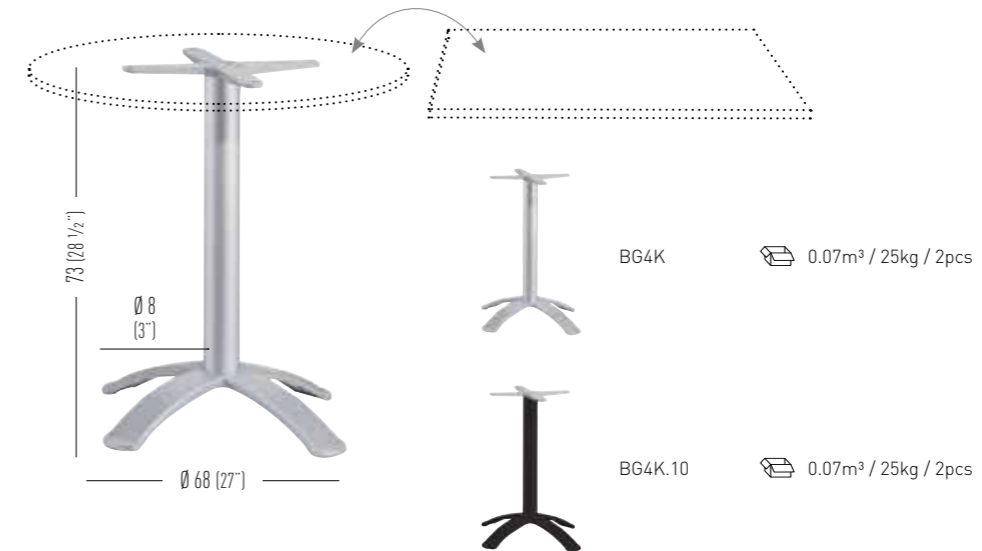

## BG4J

H73 4-spur metal-technopolymer co-injected table base, 80x80mm anodized aluminum column with cross.  
Base per tavolo H73 a quattro razze in metallo sovrastampato con tecnopolimero, colonna in alluminio anodizzato 80x80mm, crociera.

Top max dimensions / Massima dimensione piano

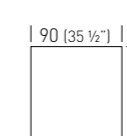
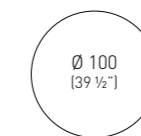

Available table tops / Piani tavolo disponibili

compactop  
laminated  
iron

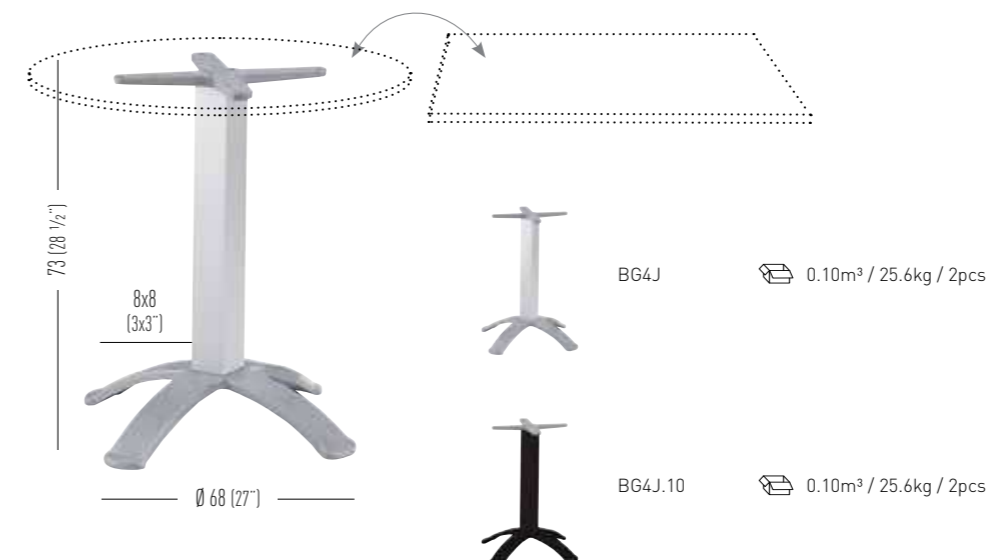

# BGPK

H73 4-spur metal-technopolymer co-injected table base, Ø 80mm anodized aluminum column with flip-top mechanism.

Base per tavolo pieghevole H73 a quattro razze in metallo sovrastampato con tecnopolimero, colonna in alluminio anodizzato Ø 80mm.



Top max dimensions / Massima dimensione piano

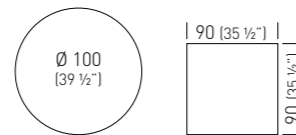

Available table tops / Piani tavolo disponibili

compactop  
laminated  
iron

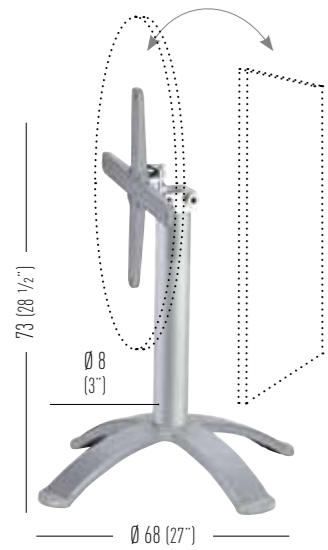

BGPK 0.07m³ / 27kg / 2pcs



BGPK.10 0.07m³ / 27kg / 2pcs

# BGA4K

H115 4-spur metal-technopolymer co-injected table base, Ø 80mm anodized aluminum column with cross.

Base per tavolo H115 a quattro razze in metallo sovrastampato con tecnopolimero, colonna in alluminio anodizzato Ø 80mm, crociera.



Top max dimensions / Massima dimensione piano

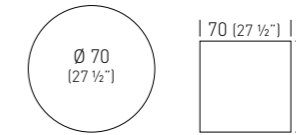

Available table tops / Piani tavolo disponibili

compactop  
laminated  
iron

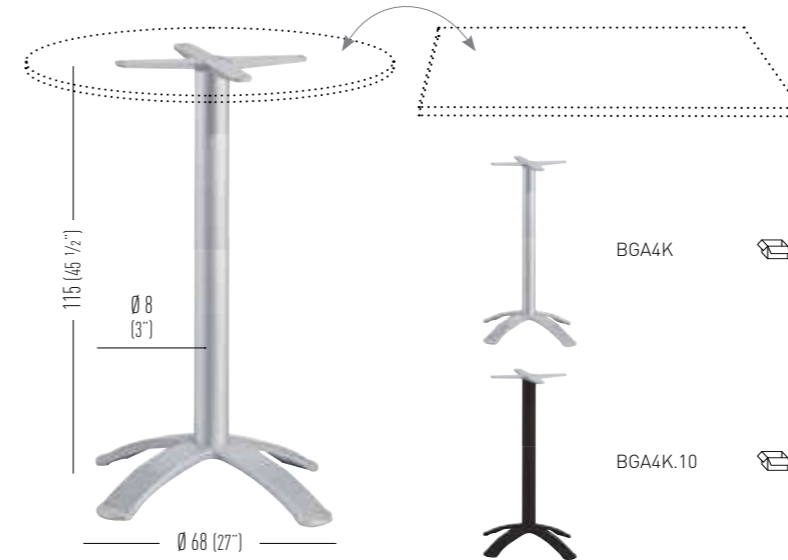

BGA4K 0.11m³ / 26.60kg / 2pcs

BGA4K.10 0.11m³ / 26.60kg / 2pcs

# BGPJ

H73 4-spur metal-technopolymer co-injected table base, 80x80mm anodized aluminum column with flip-top mechanism.

Base per tavolo pieghevole H73 a quattro razze in metallo sovrastampato con tecnopolimero, colonna in alluminio anodizzato 80x80mm.



Top max dimensions / Massima dimensione piano

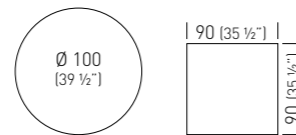

Available table tops / Piani tavolo disponibili

compactop  
laminated  
iron

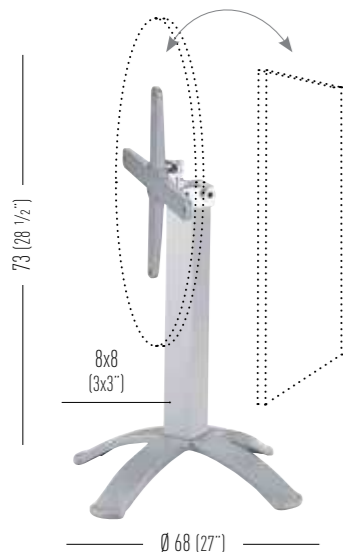

BGPJ 0.10m³ / 27.60kg / 2pcs



BGPJ.10 0.10m³ / 27.60kg / 2pcs



## BPG4K

H73 4-spur metal-technopolymer co-injected table base, Ø 60mm anodized aluminum column with cross.  
 Base per tavolo H73 a quattro razze in metallo sovrastampato con tecnopolimero, colonna in alluminio anodizzato Ø 60mm, crociera.



Top max dimensions / Massima dimensione piano

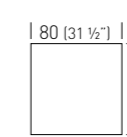
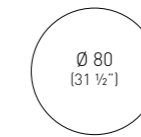

Available table tops / Piani tavolo disponibili

compactop  
 laminated  
 iron

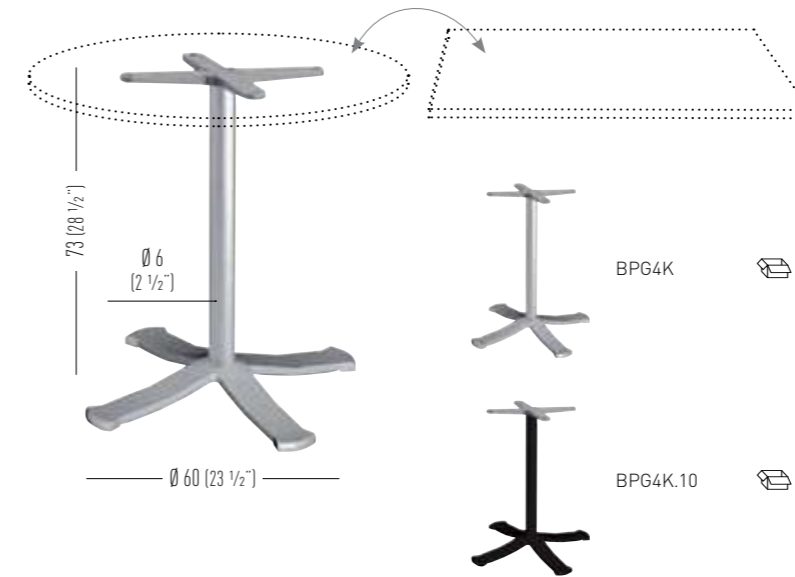

BPG4K 0.07m³ / 17kg / 2pcs

BPG4K.10 0.07m³ / 17kg / 2pcs



## BG4IP

H73 stacking 4-spur metal-technopolymer co-injected table base, Ø 80mm round anodized aluminum column with flip-top mechanism. Adjustable feet. Base per tavolo pieghevole e accatastabile H73 a quattro razze in metallo sovrastampato con tecnopolimero, colonna in alluminio anodizzato Ø 80mm. Piedini regolabili.



Top max dimensions / Massima dimensione piano

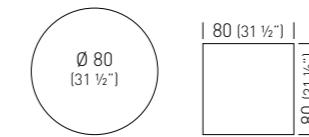

Available table tops / Piani tavolo disponibili

compactop  
laminated  
iron

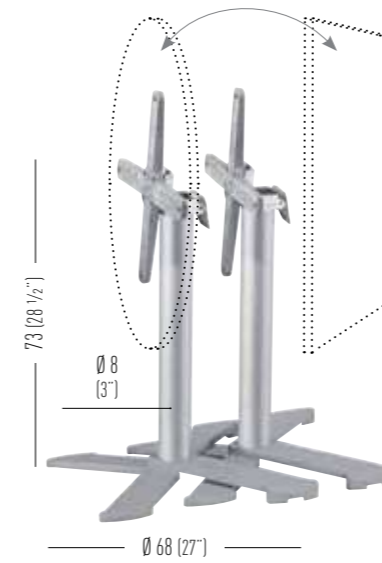

BG4IP 0.07m³ / 20kg / 2pcs



BG4IP.10 0.07m³ / 20kg / 2pcs





## BG2J

H73 double metal-technopolymer co-injected table base, 80x80mm anodized aluminum column with cross. Base doppia per tavolo H73 in metallo sovrastampato con tecnopolimero, colonna in alluminio anodizzato 80x80mm, crociera.

Top max dimensions / Massima dimensione piano

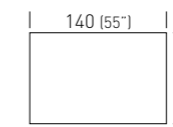

Available table tops / Piani tavolo disponibili

compactop  
laminated  
iron

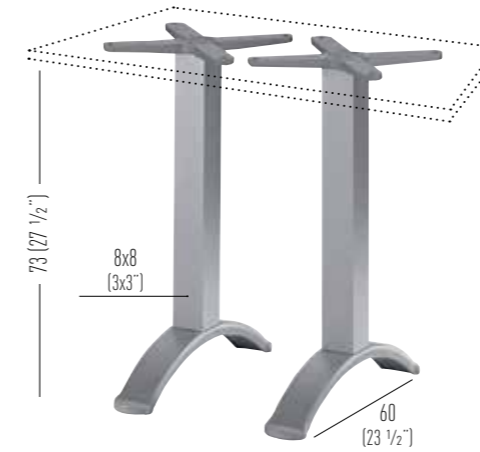

BG2J

0.07m³ / 30kg / 2pcs



BG2J.10

0.07m³ / 30kg / 2pcs



## BTK

H73 round metal-technopolymer co-injected table base, Ø 80mm anodized aluminum column with cross.  
 Base per tavolo H73 rotonda in metallo sovrastampato con tecnopolimero, colonna in alluminio anodizzato Ø 80mm, crociera.

Top max dimensions / Massima dimensione piano



Available table tops / Piani tavolo disponibili

compactop  
laminated  
iron

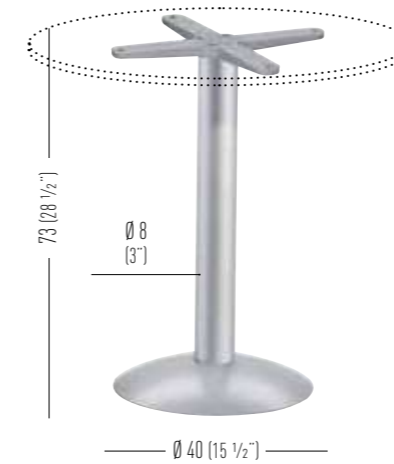

BTK 0.10m³ / 19.60kg / 2pcs

BTK.10 0.10m³ / 19.60kg / 2pcs

## BTAK

H110 round metal-technopolymer co-injected table base, Ø 80mm anodized aluminum column with cross.  
 Base per tavolo H110 rotonda in metallo sovrastampato con tecnopolimero, colonna in alluminio anodizzato Ø 80mm, crociera.

Top max dimensions / Massima dimensione piano



Available table tops / Piani tavolo disponibili

compactop  
laminated  
iron



BTAK 0.11m³ / 21.60kg / 2pcs

BTAK.10 0.11m³ / 21.60kg / 2pcs



## BTK54

H73 round metal-technopolymer co-injected table base, Ø 80mm anodized aluminum column with cross. Base per tavolo H73 rotonda in metallo sovrastampato con tecnopolimero, colonna in alluminio anodizzato Ø 80mm, crociera.

Top max dimensions / Massima dimensione piano



Available table tops / Piani tavolo disponibili

compactop  
laminated  
iron

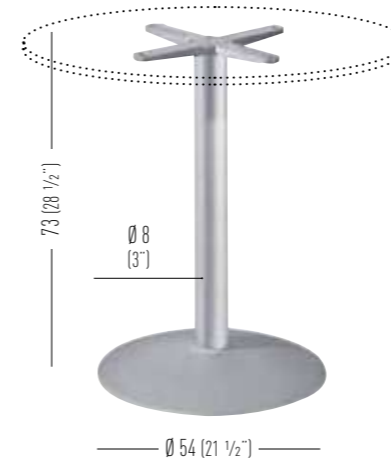

BTK54 0.10m³ / 24.60kg / 2pcs

BTK54.10 0.10m³ / 24.60kg / 2pcs

## BTAK54

H110 round metal-technopolymer co-injected table base, Ø 80mm anodized aluminum column with cross. Base per tavolo H110 rotonda in metallo sovrastampato con tecnopolimero, colonna in alluminio anodizzato Ø 80mm, crociera.

Top max dimensions / Massima dimensione piano



Available table tops / Piani tavolo disponibili

compactop  
laminated  
iron

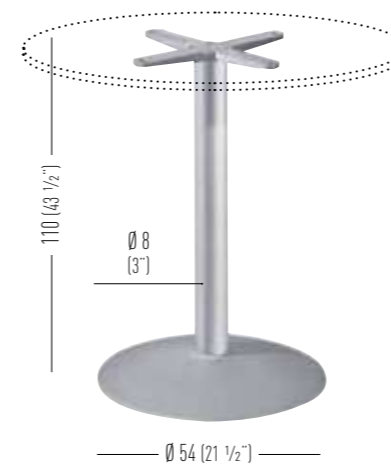

BTAK54 0.11m³ / 25.60kg / 2pcs

BTAK54.10 0.11m³ / 25.60kg / 2pcs



## BRCV

H73 round metal-techno-polymer co-injected table base, Ø 50mm metal painted column with cross.  
 Base per tavolo H73 rotonda in metallo sovrastampato con tecnopolimero, colonna in metallo verniciato Ø 50mm, crociera.



Top max dimensions / Massima dimensione piano



Available table tops / Piani tavolo disponibili

compactop  
 laminated  
 iron



BRCV  0.07m³ / 15kg / 2pcs



BRCV.10  0.07m³ / 15kg / 2pcs



# VENUS ROUND

H73 metal-technopolymer co-injected table base.  
 Base per tavolo H73 rotonda in metallo sovrastampato con tecnopolimero.



Top max dimensions / Massima dimensione piano



Available table tops / Piani tavolo disponibili

compactop  
 laminated  
 iron

Additional weight on request (+3).  
 Peso supplementare disponibile su richiesta (+3).



BGVR.00 0.2m³ / 6kg / 1pcs  
 BGVR.00+3kg 0.2m³ / 9kg / 1pcs



# VENUS SQUARE

H73 metal-technopolymer  
co-injected table base.  
Base per tavolo H73 quadrata  
in metallo sovrastampato con  
tecnopolimero.

Top max dimensions / Massima dimensione piano

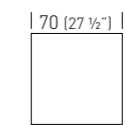

Available table tops / Piani tavolo disponibili

compactop  
laminated  
iron

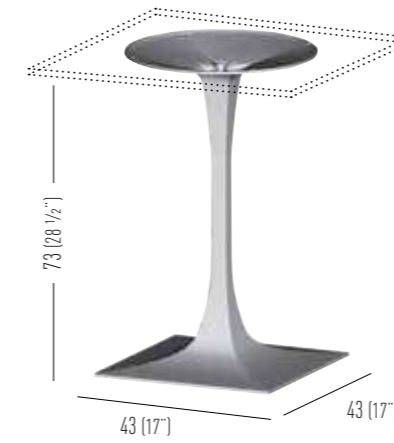

BGVQ.00

0.2m³ / 7kg / 1pcs



# BRK

H73 round metal-technopolymer co-injected table base, Ø 80mm anodized aluminum column with cross. Base per tavolo H73 rotonda in metallo sovrastampato con tecnopolimero, colonna in alluminio anodizzato Ø 80mm, crociera.

Top max dimensions / Massima dimensione piano

Available table tops / Piani tavolo disponibili

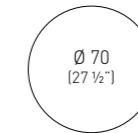

compactop  
laminated  
iron

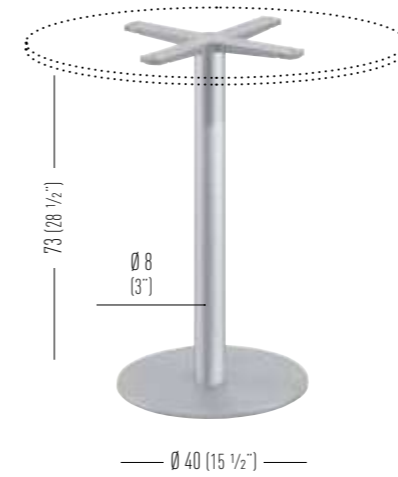

BRK 0.07m³ / 20.60kg / 2pcs

BRK.10 0.07m³ / 20.60kg / 2pcs



## BQJ

H73 square metal-technopolymer co-injected table base, 80x80mm anodized aluminum column with cross.  
 Base per tavolo H73 quadrata in metallo sovrastampato con tecnopolimero, colonna in alluminio anodizzato 80x80mm, crociera.

Top max dimensions / Massima dimensione piano

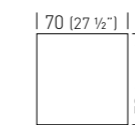

Available table tops / Piani tavolo disponibili

compactop  
laminated  
iron



BQJ 0.07m³ / 24.60kg / 2pcs

BQJR 0.07m³ / 24.60kg / 2pcs  
Adjustable feet / Piedini regolabili



BQJ.10 0.07m³ / 24.60kg / 2pcs

BQJR.10 0.07m³ / 24.60kg / 2pcs  
Adjustable feet / Piedini regolabili

## BQAJ

H103 square metal-technopolymer co-injected table base, 80x80mm square anodized aluminum column with cross.  
 Base per tavolo H103 quadrata in metallo sovrastampato con tecnopolimero, colonna quadrata in alluminio anodizzato 80x80mm, crociera.

Top max dimensions / Massima dimensione piano

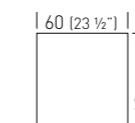

Available table tops / Piani tavolo disponibili

compactop  
laminated  
iron



BQAJ 0.08m³ / 25.60kg / 2pcs

BQAJR 0.08m³ / 25.60kg / 2pcs  
Adjustable feet / Piedini regolabili



BQAJ.10 0.08m³ / 25.60kg / 2pcs

BQAJR.10 0.08m³ / 25.60kg / 2pcs  
Adjustable feet / Piedini regolabili





# LEI

H73 or H110 4-spur metal-technopolymer co-injected table base, Ø 60mm anodized aluminum column with cross.

Base per tavolo H73 o H110 a quattro razze in metallo sovrastampato con tecnopolimero, colonna in alluminio anodizzato Ø 60mm, crociera.

Top max dimensions / Massima dimensione piano

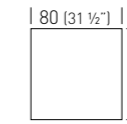

Only H110 / Solo H110

Available table tops / Piani tavolo disponibili

compactop  
laminated  
iron

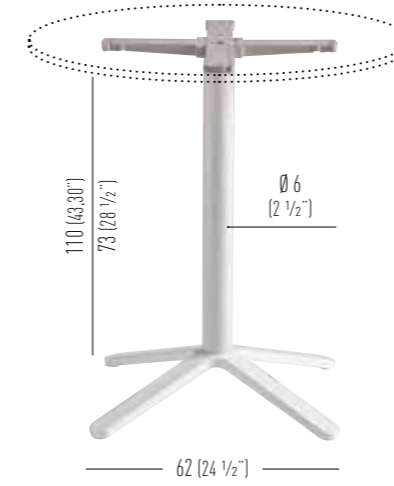

BLEI.00 0.07m³ / 8.5kg / 1pcs

BLEIA.00 0.09m³ / 9kg / 1pcs



BLEI.10 0.07m³ / 8.5kg / 1pcs

BLEIA.10 0.09m³ / 9kg / 1pcs



# AMICA

H73 4-spur table base collection made of die-cast painted aluminum, Ø60mm polymer-steel co-injected column with cross. Adjustable feet.  
 Collezione basamenti per tavoli H73 a quattro razze in alluminio pressofuso verniciato, colonna in metallo-polimero Ø60mm, con crociera. Piedini regolabili.



Available table tops / Piani tavolo disponibili

compactop  
laminated  
iron

Top max dimensions / Massima dimensione piano

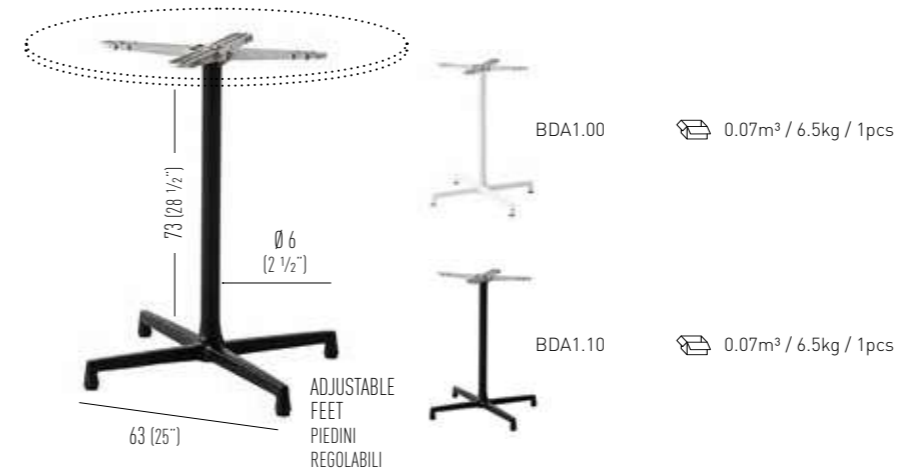
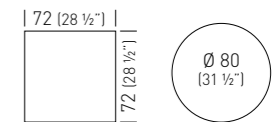

Top max dimensions / Massima dimensione piano

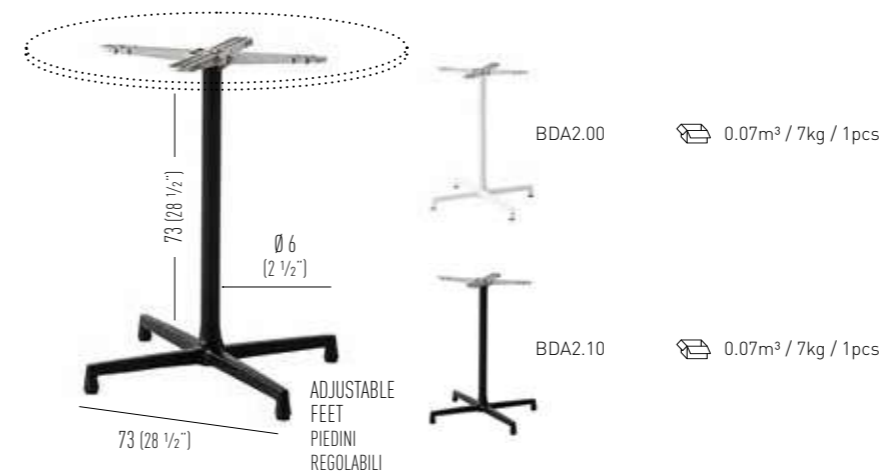
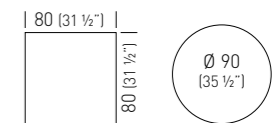

Top max dimensions / Massima dimensione piano

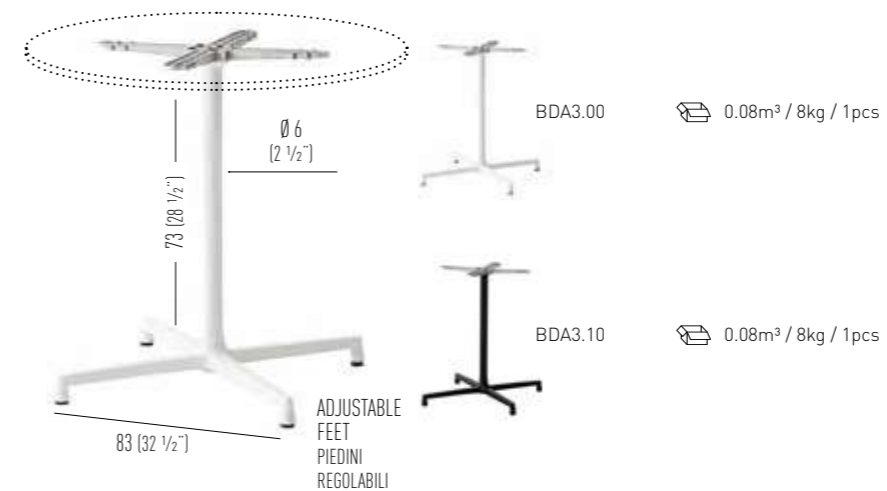
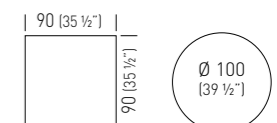



## R1

H50-H74-H110 round steel table base,  
 Ø 80mm steel column with cross.  
 Base per tavolo rotonda in acciaio  
 H50, H74 e H110, colonna in acciaio Ø  
 80mm, crociera.

Top max dimensions / Massima dimensione piano

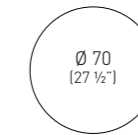

Available table tops / Piani tavolo disponibili

compactop  
 laminated  
 iron

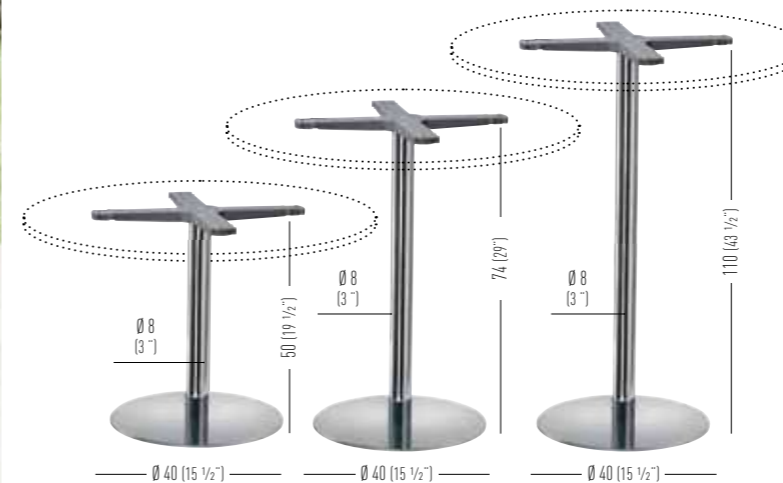

Finishes for R bases / Finiture per basamenti serie R

Polished Steel-Chromed Column / Acciaio Lucido-Colonna Cromata

Polished Steel	H50	BAR1B.A	0.07m <sup>3</sup> / 15kg / 1pcs
	H74	BAR1.A	0.07m <sup>3</sup> / 15kg / 1pcs
	H110	BAR1A.A	0.09m <sup>3</sup> / 17kg / 1pcs

Satin Steel-Satin Column / Acciaio Satinato-Colonna Satinata

Satin Steel	H50	BAR1B.S	0.07m <sup>3</sup> / 15kg / 1pcs
	H74	BAR1.S	0.07m <sup>3</sup> / 15kg / 1pcs
	H110	BAR1A.S	0.09m <sup>3</sup> / 17kg / 1pcs

White Painted / Verniciata Bianca

White Painted	H50	BAR1B.00	0.07m <sup>3</sup> / 15kg / 1pcs
	H74	BAR1.00	0.07m <sup>3</sup> / 15kg / 1pcs
	H110	BAR1A.00	0.09m <sup>3</sup> / 17kg / 1pcs

Black Painted / Verniciata Nera

Black Painted	H50	BAR1B.10	0.07m <sup>3</sup> / 15kg / 1pcs
	H74	BAR1.10	0.07m <sup>3</sup> / 15kg / 1pcs
	H110	BAR1A.10	0.09m <sup>3</sup> / 17kg / 1pcs

## R2

H50-H74-H110 round steel table base,  
 Ø 80mm steel column with cross.  
 Base per tavolo rotonda in acciaio  
 H50, H74 e H110, colonna in acciaio Ø  
 80mm, crociera.

Top max dimensions / Massima dimensione piano

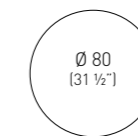

Available table tops / Piani tavolo disponibili

compactop  
 laminated  
 iron

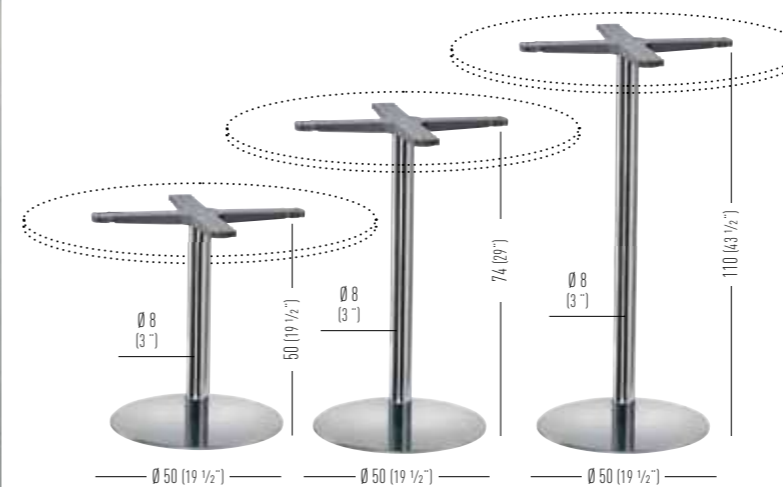

Finishes for R bases / Finiture per basamenti serie R

Polished Steel-Chromed Column / Acciaio Lucido-Colonna Cromata

Polished Steel	H50	BAR2B.A	0.07m <sup>3</sup> / 18kg / 1pcs
	H74	BAR2.A	0.07m <sup>3</sup> / 18kg / 1pcs
	H110	BAR2A.A	0.09m <sup>3</sup> / 20kg / 1pcs

Satin Steel-Satin Column / Acciaio Satinato-Colonna Satinata

Satin Steel	H50	BAR2B.S	0.07m <sup>3</sup> / 18kg / 1pcs
	H74	BAR2.S	0.07m <sup>3</sup> / 18kg / 1pcs
	H110	BAR2A.S	0.09m <sup>3</sup> / 20kg / 1pcs

White Painted / Verniciata Bianca

White Painted	H50	BAR2B.00	0.07m <sup>3</sup> / 18kg / 1pcs
	H74	BAR2.00	0.07m <sup>3</sup> / 18kg / 1pcs
	H110	BAR2A.00	0.09m <sup>3</sup> / 20kg / 1pcs

Black Painted / Verniciata Nera

Black Painted	H50	BAR2B.10	0.07m <sup>3</sup> / 18kg / 1pcs
	H74	BAR2.10	0.07m <sup>3</sup> / 18kg / 1pcs
	H110	BAR2A.10	0.09m <sup>3</sup> / 20kg / 1pcs

# R3

H74-H110 round steel table base,  
 Ø 80mm round steel column with cross.  
 Base per tavolo rotonda in acciaio H74 e  
 H110, colonna rotonda in acciaio  
 Ø 80mm, crociera.

Top max dimensions / Massima dimensione piano

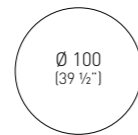

Available table tops / Piani tavolo disponibili

compactop  
 laminated  
 iron

Finishes for R bases / Finiture per basamenti serie R

Polished Steel-Chromed Column / Acciaio Lucido-Colonna Cromata

	H74	BAR3.A		0.07m³ / 21kg / 1pcs
	H110	BAR3A.A		0.09m³ / 23kg / 1pcs

Satin Steel-Satin Column / Acciaio Satinato-Colonna Satinata

	H74	BAR3.S		0.07m³ / 21kg / 1pcs
	H110	BAR3A.S		0.09m³ / 23kg / 1pcs

White Painted / Verniciata Bianca

	H74	BAR3.00		0.07m³ / 21kg / 1pcs
	H110	BAR3A.00		0.09m³ / 23kg / 1pcs

Black Painted / Verniciata Nera

	H74	BAR3.10		0.07m³ / 21kg / 1pcs
	H110	BAR3A.10		0.09m³ / 23kg / 1pcs



# T1 FLOOR FIXING

Floor Fixing H74 round steel table base,  
 Ø 80mm round steel column with cross.  
 Base per tavolo H74 rotonda in metallo  
 per fissaggio a terra, colonna rotonda in  
 metallo Ø 80mm, crociera.

Top max dimensions / Massima dimensione piano

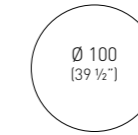

Available table tops / Piani tavolo disponibili

compactop  
 laminated  
 iron

Finishes for T1 bases / Finiture per basamenti serie T1

Polished Steel-Chromed Column / Acciaio Lucido-Colonna Cromata

	H74	BAT1.S		0.07m³ / 11kg / 1pcs
--	-----	--------	--	----------------------



# V1

H73 roundchromed metal table base,  
 Ø 50mm chromed metal column with  
 cross.  
 Base per tavolo H73 rotonda in metallo  
 cromato, colonna in metallo cromato  
 Ø 50mm, crociera.

Top max dimensions / Massima dimensione piano

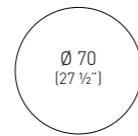

Available table tops / Piani tavolo disponibili

compactop  
 laminated  
 iron

Finishes for V1 bases / Finiture per basamenti serie V1

Polished Steel-Chromed Column / Acciaio Lucido-Colonna Cromata

	H73	BV1C		0.1m³ / 15.6kg / 2 pcs
--	-----	------	--	------------------------

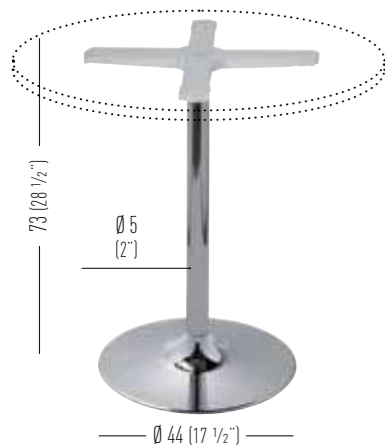



# Q1

H50-H74-H110 square steel table base,  
80x80mm steel column with cross.  
Base per tavolo quadrata in acciaio  
H50, H74 e H110, colonna in acciaio  
80x80mm, crociera.

Top max dimensions / Massima dimensione piano

Available table tops / Piani tavolo disponibili

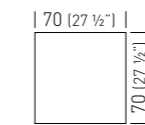

compactop  
laminated  
iron

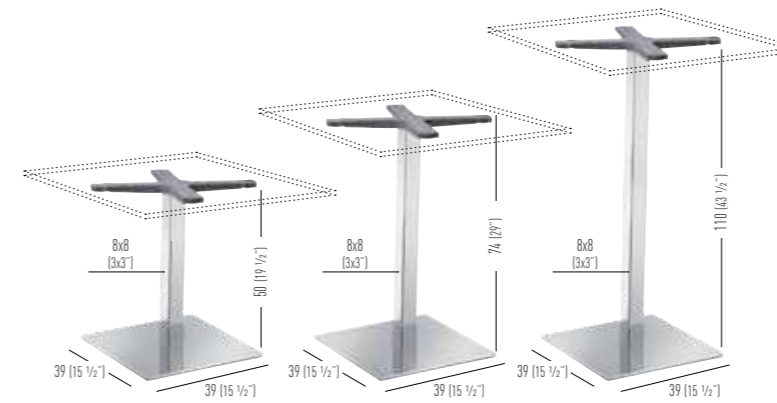

Finishes for Q bases / Finiture per basamenti serie Q

Polished Steel-Chromed Column / Acciaio Lucido-Colonna Cromata

H50	BAQ1B.A	0.07m <sup>3</sup> / 17kg / 1pcs
H74	BAQ1.A	0.07m <sup>3</sup> / 17kg / 1pcs
H110	BAQ1A.A	0.09m <sup>3</sup> / 19kg / 1pcs

Satin Steel-Satin Column / Acciaio Satinato-Colonna Satinata

H50	BAQ1B.S	0.07m <sup>3</sup> / 17kg / 1pcs
H74	BAQ1.S	0.07m <sup>3</sup> / 17kg / 1pcs
H110	BAQ1A.S	0.09m <sup>3</sup> / 19kg / 1pcs

White Painted / Verniciata Bianca

H50	BAQ1B.00	0.07m <sup>3</sup> / 17kg / 1pcs
H74	BAQ1.00	0.07m <sup>3</sup> / 17kg / 1pcs
H110	BAQ1A.00	0.09m <sup>3</sup> / 19kg / 1pcs

Black Painted / Verniciata Nera

H50	BAQ1B.10	0.07m <sup>3</sup> / 17kg / 1pcs
H74	BAQ1.10	0.07m <sup>3</sup> / 17kg / 1pcs
H110	BAQ1A.10	0.09m <sup>3</sup> / 19kg / 1pcs



## Q2

**H50-H74-H110 square steel table base, 80x80mm steel column with cross.**  
 Base per tavolo quadrata in acciaio H50, H74 e H110, colonna in acciaio 80x80mm, crociera.

Top max dimensions / Massima dimensione piano

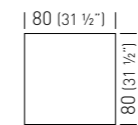

Available table tops / Piani tavolo disponibili

compactop  
laminated  
iron

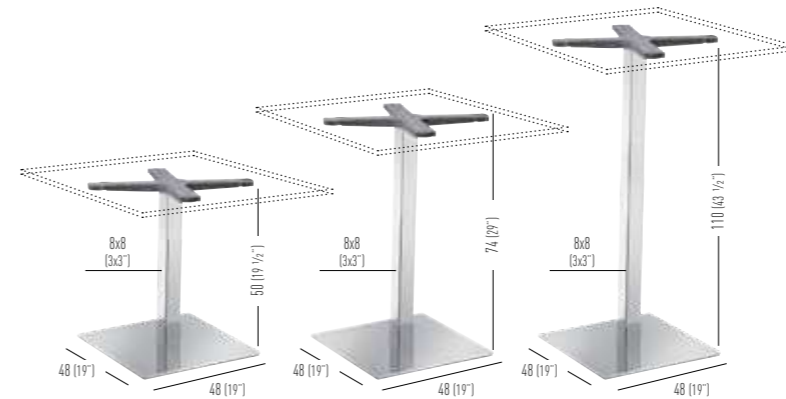

Finishes for Q bases / Finiture per basamenti serie Q

**Polished Steel-Chromed Column / Acciaio Lucido-Colonna Cromata**

H50	BAQ2B.A	0.07m <sup>3</sup> / 18kg / 1pcs
H74	BAQ2.A	0.07m <sup>3</sup> / 18kg / 1pcs
H110	BAQ2A.A	0.09m <sup>3</sup> / 20kg / 1pcs

**Satin Steel-Satin Column / Acciaio Satinato-Colonna Satinata**

H50	BAQ2B.S	0.07m <sup>3</sup> / 18kg / 1pcs
H74	BAQ2.S	0.07m <sup>3</sup> / 18kg / 1pcs
H110	BAQ2A.S	0.09m <sup>3</sup> / 20kg / 1pcs

**White Painted / Verniciata Bianca**

H50	BAQ2B.00	0.07m <sup>3</sup> / 18kg / 1pcs
H74	BAQ2.00	0.07m <sup>3</sup> / 18kg / 1pcs
H110	BAQ2A.00	0.09m <sup>3</sup> / 20kg / 1pcs

**Black Painted / Verniciata Nera**

H50	BAQ2B.10	0.07m <sup>3</sup> / 18kg / 1pcs
H74	BAQ2.10	0.07m <sup>3</sup> / 18kg / 1pcs
H110	BAQ2A.10	0.09m <sup>3</sup> / 20kg / 1pcs

## Q3

**H74-H110 square steel table base, 80x80mm steel column with cross.**  
 Base per tavolo quadrata in acciaio H74 e H110, colonna in acciaio 80x80mm, crociera.

Top max dimensions / Massima dimensione piano

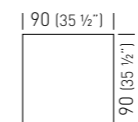

Available table tops / Piani tavolo disponibili

compactop  
laminated  
iron

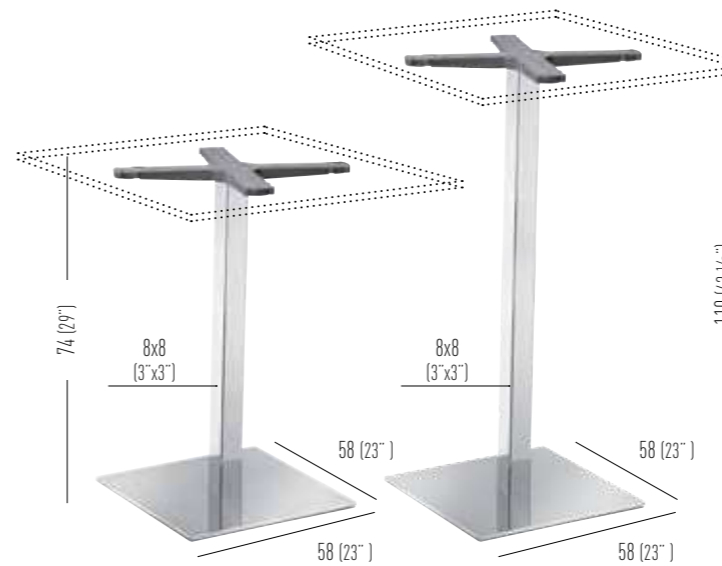

Finishes for Q bases / Finiture per basamenti serie Q

**Polished Steel-Chromed Column / Acciaio Lucido-Colonna Cromata**

H74	BAQ3.A	0.07m <sup>3</sup> / 23kg / 1pcs
H110	BAQ3A.A	0.09m <sup>3</sup> / 25kg / 1pcs

**Satin Steel-Satin Column / Acciaio Satinato-Colonna Satinata**

H74	BAQ3.S	0.07m <sup>3</sup> / 23kg / 1pcs
H110	BAQ3A.S	0.09m <sup>3</sup> / 25kg / 1pcs

**White Painted / Verniciata Bianca**

H74	BAQ3.00	0.07m <sup>3</sup> / 23kg / 1pcs
H110	BAQ3A.00	0.09m <sup>3</sup> / 25kg / 1pcs

**Black Painted / Verniciata Nera**

H74	BAQ3.10	0.07m <sup>3</sup> / 23kg / 1pcs
H110	BAQ3A.10	0.09m <sup>3</sup> / 25kg / 1pcs



## D2

H74-H110 double steel table base,  
80x80mm steel columns with cross.  
Base doppia per tavolo H74 e H110 in  
acciaio, colonne in acciaio 80x80mm,  
crociere.

Top max dimensions / Massima dimensione piano

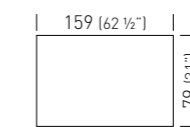

Available table tops / Piani tavolo disponibili

compactop  
laminated  
iron

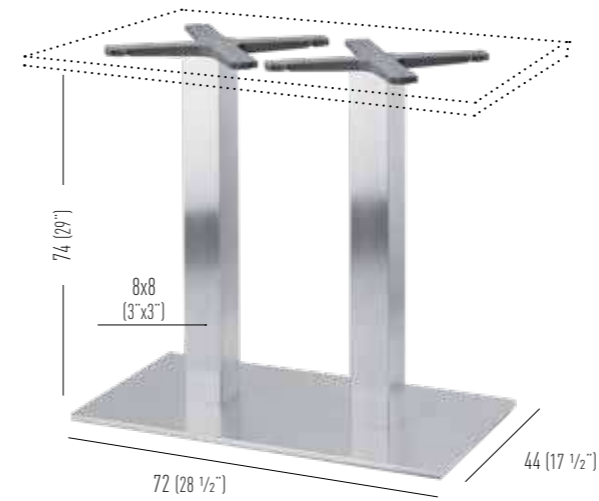

Finishes for D2 bases / Finiture per basamenti serie D2

Polished Steel-Chromed Column / Acciaio Lucido-Colonna Cromata



H74 BAD2.A 0.22m<sup>3</sup> / 32kg / 1pcs

Satin Steel-Satin Column / Acciaio Satinato-Colonna Satinata

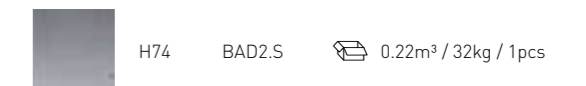

H74 BAD2.S 0.22m<sup>3</sup> / 32kg / 1pcs

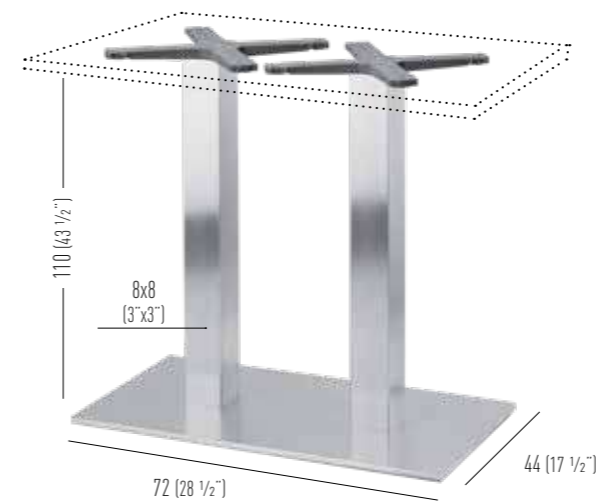

Polished Steel-Chromed Column / Acciaio Lucido-Colonna Cromata



H110 BAD2.A.A 0.22m<sup>3</sup> / 35kg / 1pcs

Satin Steel-Satin Column / Acciaio Satinato-Colonna Satinata



H110 BAD2.A.S 0.22m<sup>3</sup> / 35kg / 1pcs



# HALIFAX

Adjustable square steel table base collection, square steel column with cross.  
 Collezione basi per tavolo quadrate in acciaio ad altezza regolabile, colonna regolabile quadrata, crociera.

Top max dimensions / Massima dimensione piano

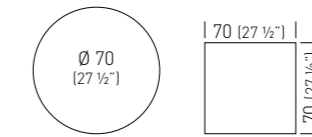

Available table tops / Piani tavolo disponibili

compactop  
laminated  
iron



Finishes for HALIFAX bases / Finiture per basamenti serie HALIFAX

Polished Steel-Chromed Column / Acciaio Lucido-Colonna Cromata



BAH1.A



0.13m³ / 18kg / 1pcs



BAH2.A



0.13m³ / 20kg / 1pcs





# ALFIE

H72 4-Spur table base collection made of painted steel, Ø100mm metal painted column with cross. Adjustable feet. Collezione basamenti per tavoli, H72, quattro razze in acciaio verniciato, colonna in metallo verniciato Ø100mm con crociera. Piedini regolabili.



Available top sizes / Dimensioni piano disponibili

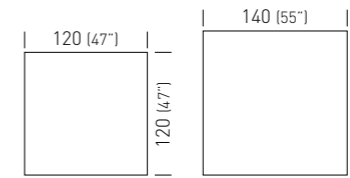

Available table tops / Piani tavolo disponibili

laminated

Black Painted / Verniciata Nera



BALF.10

0.65m<sup>2</sup> / 15kg / 1pcs



# TATAMI

H74-H110 round steel table base,  
 Ø 80mm steel similar wood-effect column with cross.  
 Base per tavolo rotonda in acciaio H74 e H110,  
 colonna finto legno Ø 80mm, crociera.

Finishes for Tatami columns / Finiture per colonne serie Tatami

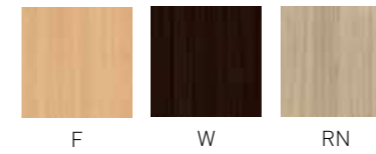

F W RN

Top max dimensions / Massima dimensione piano



Available table tops / Piani tavolo disponibili

compactop  
 laminated  
 iron

Finishes for TATAMI bases / Finiture per basamenti serie Tatami

Polished Steel / Acciaio Lucido



BARTA.A\_ 0.07m³ / 18kg / 1pcs

Satin Steel / Acciaio Satinato



BARTA.S\_ 0.07m³ / 18kg / 1pcs

White Painted / Verniciata Bianca



BARTA.00\_ 0.07m³ / 18kg / 1pcs

Black Painted / Verniciata Nera



BARTA.10\_ 0.07m³ / 18kg / 1pcs

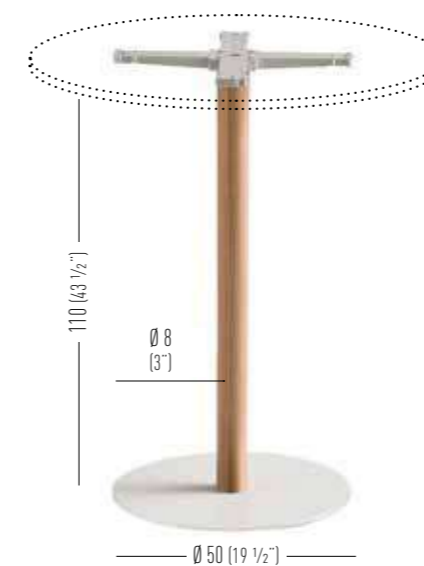
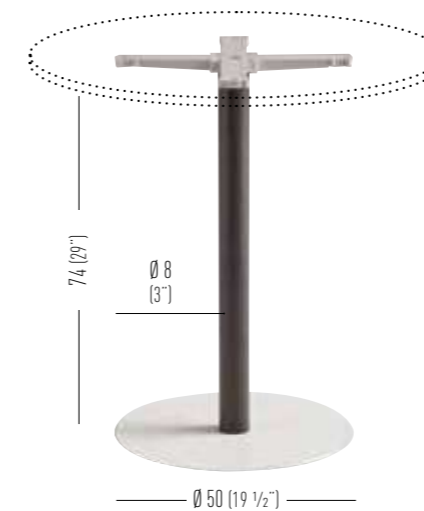

Finishes for TATAMI bases / Finiture per basamenti serie Tatami

Polished Steel / Acciaio Lucido



BARTA.A\_ 0.09m³ / 20kg / 1pcs

Satin Steel / Acciaio Satinato



BARTA.S\_ 0.09m³ / 20kg / 1pcs

White Painted / Verniciata Bianca

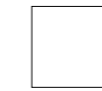

BARTA.00\_ 0.09m³ / 20kg / 1pcs

Black Painted / Verniciata Nera



BARTA.10\_ 0.09m³ / 20kg / 1pcs

# COLOURS COLORI

## Techno-polymer / Tecnopolimero

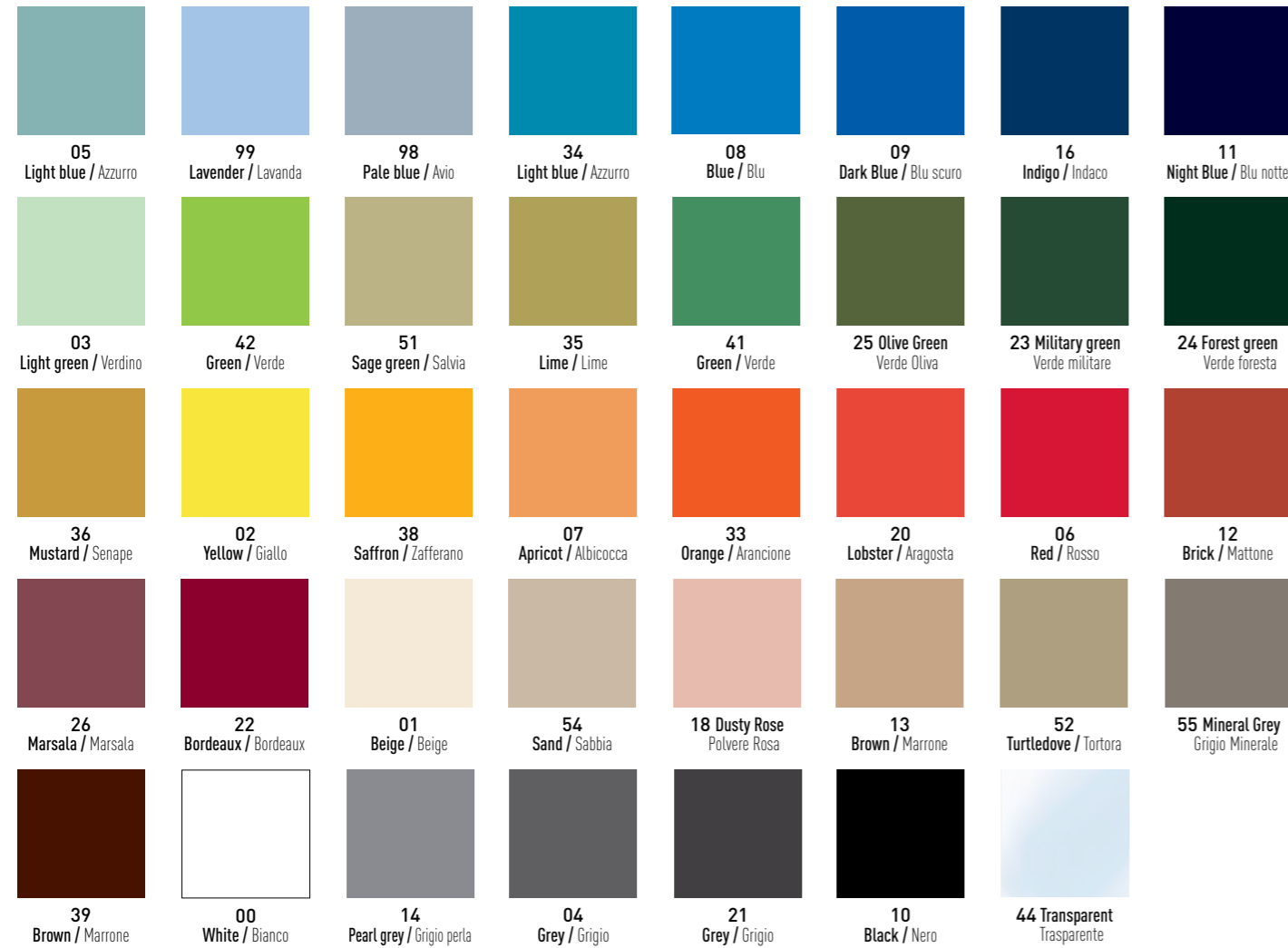

## Bases and Frames Wood finishes / Finiture Legni Basi e Telai



## Bases and Frames Metal finishes / Finiture metalli Basi e Telai

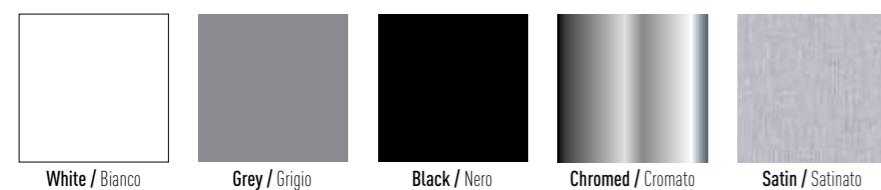

## Standard Compactop Surface

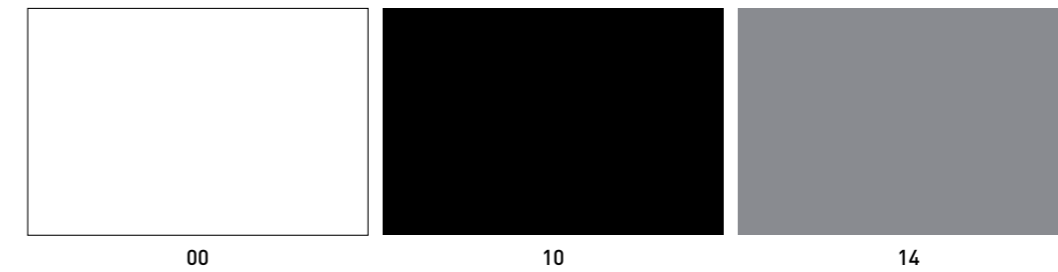

## Special Compactop Surface Fenix - [www.fenixforinteriors.com](http://www.fenixforinteriors.com)

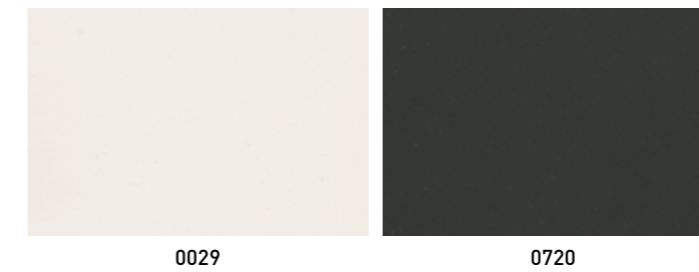

## Special Compactop Surface - Solid - [www.arpaindustriale.com](http://www.arpaindustriale.com)



## Special Compactop Surface - Wood Effect - [www.arpaindustriale.com](http://www.arpaindustriale.com)



Special Compactop Surface - Stone, Concrete, Corten and Marble Effect - [www.arpainindustriale.com](http://www.arpainindustriale.com)



3192

3349

3276

3329

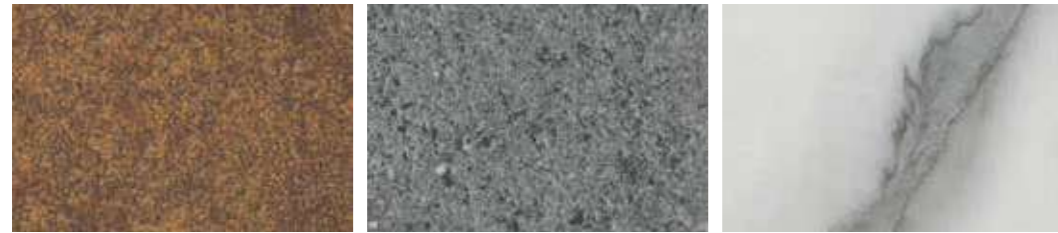

3294

3340

5547

Standard Laminated Surface

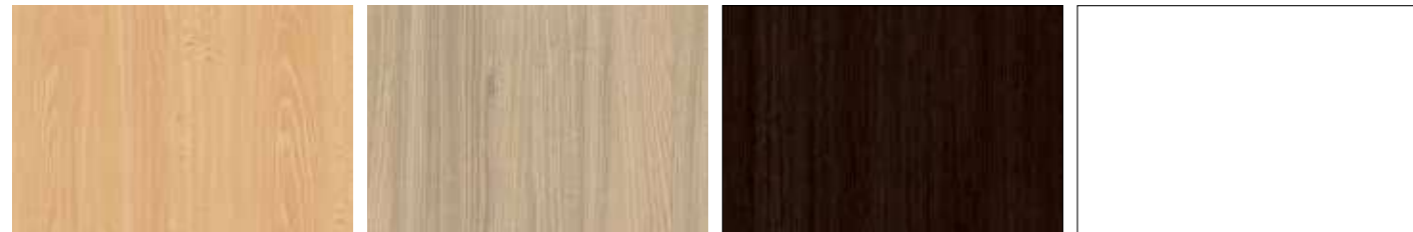

F

RN

W

00

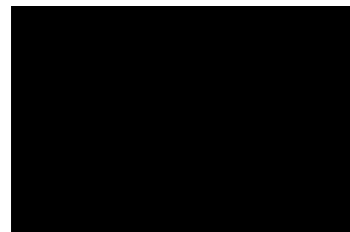

10

Special Laminated Surface - Wood Effect

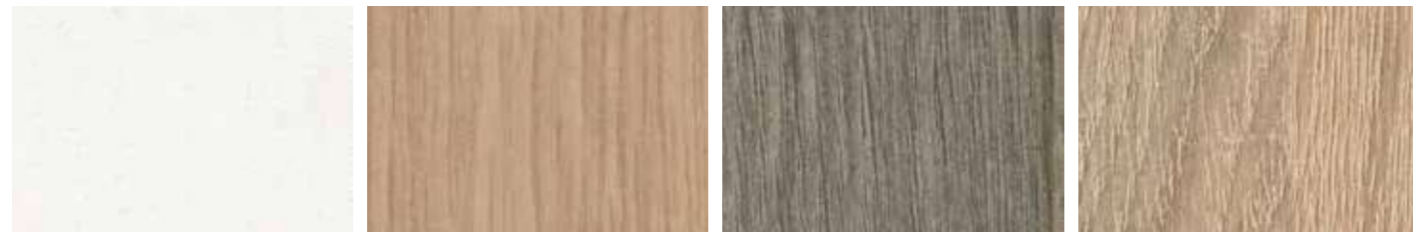

B01

X41

V32

61M

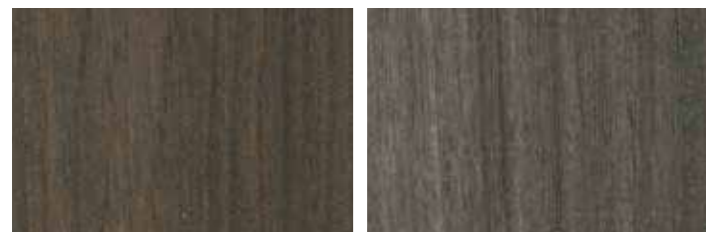

WGB

WG9

Special Laminated Surface - Fenix - [www.fenixforinteriors.com](http://www.fenixforinteriors.com)



0029

720

718

2630



2629

2628





## GABER® LITERATURE

All Gaber® literature contains technical information and use-suggestions for those who intend to purchase or already have bought items from the Gaber® range. For Customers' interest, the Company may modify its products without any prior notice. Drawings, quoted materials and catalogue colors and price-lists are shown as a guide only and subject to tolerances. Dimensions are provided also in inches (") has a guide only. The colors displayed in Gaber® literature, related to technopolymer finishing and coverings, fabrics, leather, lacquered or painted materials, wooden items, may change from time to time. Gaber® reserves the right to suspend the production of any of its products without any notice or reason. All rights of reproduction in whole or in part of Gaber® literature, related to text, images or illustration, or transmitted by any means, electronic or mechanical, including photocopying, recording or any information storage without written permission from Gaber®, are reserved worldwide

## MATERIALS, USE AND MAINTENANCE

### Plastic Materials

The Techno Polymer Compounds Gaber® uses on its products are characterized by high structural resistance, heat and abrasion resistance. Gaber® technopolymers are non-toxic, stain resistant, antistatic and UV-resistant: thanks to all these features these materials have excellent resistance to atmospheric agents. All these materials are recyclable in the full respect of our Natural Environment. Gaber produces plastic injected materials without added chemicals and, as far as possible, recycled technopolymers are sourced as a base raw material, recovered post-consumption.

Guidelines for correct usage: Do not expose plastic surfaces to direct heat sources. Plastic surfaces of Gaber® products usually need to be cleaned with a normal cloth and warm water. For the most persistent stains, a small amount of liquid soap diluted in water may be used. Strictly avoid the use of acetone, trichloroethylene, ammonia, alcoholic substances and detergents containing even a small amount of those substances. We also recommend avoiding all types of abrasive and solvent substances or rough sponges. Any liquid spilt on the product must be wiped up immediately. Even products made especially for outdoor purposes could be affected by atmospheric agents. Products may undergo exterior changes due to particular exposure to heat, humidity and salinity. Products may change color and shade if exposed to direct sunlight. An appropriate and frequent maintenance and cleaning of the products enhances its durability. Maintenance has to be carried out by experienced staff.

Gaber® glides and floorpads are made of blended rubber for heavy-duty use and are designed to minimise noise. Certain Gaber® items come ready-fitted with felt floorpads, specifically for hard or especially delicate floors.

Gaber® manufactures some bespoke products of its collection with fire retardant techno polymer: the additives that make the fireproof plastic can substantially change the aesthetics and durability of the product.

### Steel

High-resistance steel is used to produce frames for chairs, stools and tables by using square or round tubes as well as solid rod. Products are available in chrome or painted finishes. Special epoxy powder coating used on many Gaber® structures achieves excellent resistance to atmospheric agents.

### Aluminum

Gaber® use aluminum to produce frames for chairs, stools and tables. Aluminum surfaces can be anodized, and Gaber® use this special treatment in order to increase resistance to corrosion.

Guidelines for correct usage: both steel and aluminum surfaces usually need to be cleaned with a normal cloth and warm water. For the most persistent stains, a small amount of mild liquid soap diluted in water may be used. Any liquid spilt on the product must be wiped up immediately. We recommend avoiding all types of abrasive creams or pastes, abrasive sponges, chlorine, bleach or strong detergents.

### Wood

Our wooden articles are produced in accordance with the European Regulations in force regarding formaldehyde emissions from wood-based products.

Guidelines for correct usage: Wooden articles, being natural materials, can be damaged easily. Small impurities or imperfections are within quality standard range. Plywood surfaces need to be cleaned with a cloth and water. We recommend drying immediately after the cleaning process.

### Flexible polyurethane padding

The flexible polyurethane cold-pressed paddings Gaber® uses on some of its upholstered articles do not contain CFC/HCFC (ODP=0: do not contribute the reduction of the atmospheric ozone layer), they are fire-retardant class 1-IM UNI 9175 / CMHR following European Standards.

### Coverings: Fabrics and Leathers

Gaber® uses fabrics and leathers that belong to a wide range of colors and patterns, which are all tested in order to achieve the best performance, among which resistance to abrasion and artificial light. Fire-retardant fabrics and eco-leather upholstery are also available.

Guidelines for correct usage: Clean leathers with a soft cloth with water. Refer to technical specifications for fabric cleaning.

## PACKAGING AND RECYCLING

Our packages are designed to optimize storage and transport requirements, they are made of 90% recycled raw material and are completely recyclable in themselves. The optimization of packaging in terms of volume and weight delivers a lower consumption of energy in many forms, helping the environment and a consequent saving on transport costs. In order to avoid the loss of components, packaging must be disposed only after completing the assembly of the products. Once the product has been dismantled, the product itself or its components must be given to public garbage system, according to local rules.

## INNAPROPRIATE USES OF THE PRODUCT

Avoid any improper use of the product; do not step on the product, do not stand on footrest or on armrests, do not seat on the back or on armrest, do not use the chair as a ladder. The product should not be subjected to swinging back and forwards that may damage the furniture or result in injury to the user. When lifting or moving the product, hold it by the main structure and not just under the seat. Gaber® will accept no liability for any damages caused to property or persons subsequent to incorrect or improper handling of the product. Gaber® also declines any responsibility in cases of damage caused to fragile floors.



## DOCUMENTAZIONE GABER®

La documentazione Gaber® contiene informazioni tecniche e consigli d'uso per chi vuole acquistare o possiede articoli facenti parte della gamma prodotti Gaber®. Nell'interesse della clientela, Gaber® si riserva il diritto di modificare i propri modelli in ogni momento, senza obbligo di preavviso. I disegni, le quote, i materiali ed i colori dei cataloghi e del listino Gaber® si intendono a titolo puramente indicativo, e soggetti a tolleranze. Le dimensioni in pollici (") sono da considerarsi indicative. I toni di colore rappresentati o presenti nelle palette colori e rivestimenti, relativi ai tessuti, alla pelle, alle laccature, ai vetri, e alle essenze legno, sono indicativi, in quanto passibili di variazioni da partita a partita. Gaber® declina ogni responsabilità in relazione a leggere differenze di tonalità. Gaber® si riserva inoltre il diritto di ritirare, sospendere o cessare la produzione di ogni singolo suo prodotto in qualsiasi momento e a sua discrezione senza darne preventivo avviso. Tutti i diritti di riproduzione, anche parziale, di cataloghi e listini Gaber® relativi a testi, immagini, illustrazioni, disegni, sia con mezzi meccanici che elettronici, incluso fotocopie o la formazione di sorgenti di informazione, senza il preventivo permesso scritto di Gaber®, sono globalmente riservati.

## MATERIALI UTILIZZATI E MANUTENZIONE

### Le Materie Plastiche

I compound di tecnopolimeri utilizzati da Gaber® nella realizzazione dei propri prodotti sono caratterizzati da un'elevata resistenza strutturale, termica e all'abrasione. Il tecnopolimero componente dei prodotti Gaber® è atossico, antimacchia, antistatico e anti-uv: qualità che lo rendono ottimamente resistente agli agenti atmosferici. I tecnopolimeri utilizzati da Gaber® sono integralmente riciclabili, nel pieno rispetto del nostro Ambiente Naturale. Gaber produce articoli termoplastici senza additivi chimici e, ove possibile, vengono utilizzati tecnopolimeri riciclati derivanti da post-consumo.

Piccole Accortezze: I materiali plastici utilizzati non possono sopportare fonti di calore diretta sulla superficie. Le superfici plastiche dei prodotti Gaber® possono essere pulite con un panno umido e soffice imbevuto in acqua. Per le macchie più ostinate è possibile diluire in acqua del sapone neutro liquido con moderazione. Non utilizzare acetone, trielina, ammoniacca, sostanze alcoliche o detersivi che contengano anche piccole quantità di tali detergenti. Non utilizzare a contatto con il prodotto sostanze abrasive o solventi, strumenti di pulizia ruvidi. I liquidi versati sul prodotto devono essere asciugati subito. I prodotti destinati all'uso esterno subiscono comunque nel tempo l'azione degli agenti atmosferici. Eventuali alterazioni superficiali possono verificarsi a specifiche condizioni di temperatura, umidità e salinità. Il prodotto se esposto alla luce diretta del sole può essere soggetto a variazioni di colore. Una corretta e frequente manutenzione e pulizia aumentano la durabilità del prodotto. Interventi di manutenzione devono essere eseguiti da personale esperto.

I tappi e le protezioni dei prodotti Gaber® sono realizzati in una miscola di gomma ad alta resistenza all' usura, atta a diminuire il rumore da trascinamento. Alcuni prodotti Gaber® sono dotati di tappi con feltri, adatti a pavimenti rigidi e più delicati.

Gaber® realizza su commessa alcuni prodotti della propria collezione con tecnopolimeri ignifughi: gli additivi che rendono il manufatto plastico ignifugo possono variare sostanzialmente l'estetica e la resistenza del prodotto.

### L' Acciaio

L'acciaio ad alta resistenza è utilizzato nelle strutture di tavoli, sedie e sgabelli, realizzati da Gaber® per mezzo di tubolari a sezione quadrata e rotonda, o con tondino. I prodotti sono disponibili con finitura cromata o verniciata. La speciale verniciatura a polveri epossidiche utilizzata da Gaber® per alcune strutture dei propri prodotti raggiunge una resistenza ottimale agli agenti atmosferici.

### L' Alluminio

Gaber® utilizza l'alluminio per realizzare le strutture di tavoli, sedie e sgabelli. La finitura per mezzo del trattamento superficiale di anodizzazione, utilizzata in alcuni prodotti, ha lo scopo di aumentarne la resistenza alla corrosione.

Piccole Accortezze: sia le superfici metalliche in acciaio che in alluminio devono essere pulite con un panno umido e soffice imbevuto in acqua calda. Per le macchie più ostinate è possibile diluire in acqua del sapone neutro liquido con moderazione. Asciugare sempre dopo la pulizia con un panno morbido. Non usare creme o paste per pulire i metalli, non usare cloro, candeggina o detergenti aggressivi. Non usare paste o spugne abrasive che possano graffiare le superfici metalliche.

### Il legno

I prodotti Gaber® con elementi in legno sono prodotti di accordo con le vigenti normative Europee rispetto alle emissioni di formaldeide. "Compound-wood" è il particolare materiale utilizzato da Gaber® per la realizzazione dei prodotti Alhambra-Eco ed Epica-Eco. Questo materiale utilizza fibre di legno derivanti dagli stessi processi di produzione con cui Gaber realizza elementi in materiale legnoso. Niente viene sprecato.

Piccole Accortezze: Le superfici in legno, essendo un materiale naturale, potrebbero, nel tempo, subire alterazioni di colore con l'utilizzo e con l'esposizione alla luce. Inoltre, per loro natura, tali superfici sono facilmente danneggiabili, alcune piccole impurità e imperfezioni rientrano negli standard di qualità accettati. Le superfici in legno non possono sopportare fonti di calore dirette. Pulire le superfici in legno con un panno umido e soffice, imbevuto in acqua tiepida. Asciugare immediatamente dopo la pulizia.

### Le imbottiture in poliuretano flessibile

Le imbottiture di alcuni prodotti Gaber® sono realizzate in poliuretano flessibile, stampato a freddo, privo di CFC/HCFC (ODP=0 : non contribuisce alla riduzione dello strato di ozono atmosferico), autoestinguente classe 1-IM Uni 9175 / CMHR, seguendo le normative Europee in materia.

### I rivestimenti: tessuti e pelli

Tessuti e Pelli utilizzati da Gaber® appartengono ad un'ampia gamma di colori e trame, tutti scelti tra un range di prodotti testati con l'obiettivo di ottenere le migliori caratteristiche prestazionali, quali la resistenza all'abrasione, allo sfregamento e alla resistenza alla luce artificiale. Sono disponibili categorie di tessuti ignifughi e rivestimenti in finte pelli.

Piccole Accortezze: pulire le Pelli con un panno bianco umido di sola acqua. Per la pulizia dei tessuti consultare la scheda tecnica specifica.

## IMBALLI E RICICLO

I nostri imballi sono realizzati con l'obiettivo di ottimizzare trasporti e stoccaggio; sono realizzati per il 90% di materiali riciclati e totalmente riciclabili. L'ottimizzazione dell'imballo in termini di volume e peso comporta un minore dispendio di energia, con un conseguente risparmio nei costi di trasporto e un importante aiuto alla salvaguardia del nostro Ambiente Naturale. E' consigliabile lo smaltimento degli imballi solo a completamento dell'assemblaggio, onde evitare lo smarrimento di eventuale ferramenta e componenti. Una volta dismesso, il prodotto o i suoi componenti vanno conferiti ai sistemi pubblici di smaltimento secondo quanto previsto dalla legislazione locale in vigore.

## USO IMPROPRIO DEI PRODOTTI

Sono da considerarsi usi impropri e/o scorretti del prodotto il salire in piedi su tavoli, sedie, sgabelli, poggiapiedi, sedersi su schienali, braccioli, utilizzare i prodotti come scaletta. Evitare oscillazioni che potrebbero pregiudicare il funzionamento e la sicurezza dell'utente. Per sollevare o spostare un prodotto non afferrare sotto il sedile, bensì afferrare saldamente la struttura portante. Il prodotto non deve essere sottoposto a carichi decentrati, è stato progettato per essere utilizzato in condizioni normali di appoggio (su quattro gambe o sulla base). Gaber® declina ogni responsabilità per danni causati a cose o a persone derivanti da uso non corretto del prodotto; l'azienda inoltre si solleva da ogni responsabilità per danni provocati su pavimenti e superfici delicate o tenere.



### DOCUMENTACION GABER®

Toda la documentación Gaber® contiene una serie de informaciones técnicas y consejos para el utilize para quién quiera comprar o para quién posea productos pertenienices a la gama Gaber®. En el interés de los clientes, Gaber® se reserva el derecho de poder modificar o mejorar sus productos sin avisar antes.

Los dibujos, las medidas, los materiales y los colores se ilustran exclusivamente a modo de ejemplo y son indicativas, sujetos a tolerancias. Las tonalidad de los colores del muestrario relativas a las telas, pieles, pintura, esencias de las maderas, pueden variar según partida.

Gaber® declina todo tipo de responsabilidades con relación a pequeñas diferencias de color. Gaber® se reserva además el derecho de ritirar, suspender o cesar la producción de cualquier producto en cualquier momento y a propia discreción sin dar previo aviso.

Todos los derechos de reproducción, incluso parcial, de los catálogos y listas de precios Gaber® relativos a los textos, imágenes, ilustraciones, diseños ya sea por medios mecánicos o electrónicos, incluyendo el fotocopiado o la formación de fuentes de información, sin el permiso previo por escrito de Gaber®, son reservados a nivel mundial.

### MATERIALES, USO Y MANTENIMIENTO

#### Material Plástico

Tecno Polímeros compuestos que Gaber® utiliza en sus productos se caracterizan por una alta resistencia estructural, al calor y una alta resistencia a la abrasión. Los Tecno Polímero de Gaber® no son tóxicos, son resistentes a manchas, antiestáticos y UV-resistente: gracias a esto los materiales tienen una excelente resistencia a los agentes atmosféricos. Todos estos materiales son reciclables en el pleno respeto de nuestro medio ambiente. Gaber® produce plástico inyectado sin productos químicos y materiales añadidos y, cuando sea posible, tecnopolímero reciclados se obtienen como materia prima básica, recuperado de post-consumo.

Pequeñas atenciones a: no exponga las superficies de plástico a fuertes fuentes de calor directo. Las superficies de plástico de los productos Gaber® generalmente necesitan ser limpiados con un paño normal y agua tibia. Para las manchas más persistentes se puede utilizar una pequeña cantidad de jabón líquido diluido en agua. Estrictamente evitar el uso de acetona, tricloroetileno, amoníaco, sustancias alcohólicas y detergentes que contiene incluso sólo una pequeña cantidad de esas sustancias. Se recomienda también para evitar todo tipo de sustancias solventes y abrasivos o esponjas ásperas. Cualquier fracción de líquido sobre el producto debe ser borrado de inmediato. Incluso los productos hechos especialmente para el exterior podrían ser afectados por los agentes atmosféricos. Productos podrían someterse a posibles cambios en la exposición especial al calor, la humedad y la salinidad. En casos excepcionales y para una vida larga, los productos podrían cambiar de tonalidad y sombra, si se expone a fuerte luz solar directa. Un mantenimiento y limpieza adecuada y frecuente de los productos aumenta su durabilidad. Mantenimiento tiene que llevarse a cabo por personal de experiencia.

Los tapones de los productos Gaber® están hechos de un compuesto de goma de alta resistencia al desgaste, que reduce el ruido de arrastre. Algunos productos Gaber® están equipados con tapones con fieltro, adecuados para suelos duros y más delicados.

Gaber® fabrica sobre pedido algunos productos de su colección con tecno polímero retardante de fuego: los aditivos que hacen que el producto de plástico sean a prueba de fuego pueden variar sustancialmente la estética y la durabilidad del producto.

#### Acero

Acero de alta resistencia se utiliza para producir las estructuras de las sillas y de las mesas, utilizando tubos cuadrados o redondos, así como barilla sólida. Los productos están disponibles en cromo o acabados pintados. La pintura en polvo epoxi especial, utilizada en muchas estructuras Gaber®, logra una excelente resistencia a los agentes atmosféricos.

#### Aluminio

Gaber® utiliza aluminio, ligero y resistente, para producir estructuras para las sillas y las mesas. Superficies de aluminio pueden ser anodizado, y Gaber® utilizan este tratamiento especial con el fin de aumentar la resistencia a la corrosión.

Pequeñas atenciones a: tanto las superficies de aluminio que acero se deben limpiar con un paño normal y agua tibia. Para las manchas más persistentes se puede usar una pequeña cantidad de jabón líquido suave diluido en agua. Cualquier fracción de líquido sobre el producto debe ser borrado de inmediato. Se recomienda evitar todo tipo de cremas abrasivas o pastas, esponjas abrasivas, cloro, lejía o detergentes fuertes.

#### Las Maderas

Nuestros artículos de madera se producen de acuerdo con la normativa europea vigente en materia de emisiones de formaldehído de los productos a base de madera. Gaber utiliza materias primas de madera que vienen exclusivamente de la cadena de custodia PEFC de materiales certificados.

Pequeñas atenciones a: artículos de madera, siendo materiales naturales, podrían dañarse fácilmente. Las pequeñas impurezas o imperfecciones están dentro del rango estándar de calidad. Superficies de madera moldeada deben ser limpiadas con un paño y agua. Se recomienda secar inmediatamente después del proceso de limpieza.

#### Espumas

Gaber® utiliza en algunos de sus artículos tapizados una espuma de poliuretano inyectada dentro de un molde, toda las espumas no contienen CFC / HCFC (ODP = 0: no contribuyen a la reducción de la capa de ozono de la atmósfera), y son de clase ignifugo 1-IM Uni 9175 siguiendo Normas europeas.

#### Revestimientos: Telas y Piel

Gaber® utiliza tela y piel que pertenecen a una amplia gama de colores y diseños, que son todos probados a fin de lograr las mejores prestaciones, entre las que la resistencia a la abrasión y la luz artificial. Telas ignifugas y para exterior, tapicería en eco-piel, también están disponibles.

Pequeñas atenciones a: limpias pieles con un paño suave con agua. Consulte las especificaciones técnicas de limpieza para las telas.

#### EMPAQUE Y RECICLABILIDAD

La gama de productos Gaber® está costituida por la mayor parte de elementos completamente reciclables. Nuestros embalajes se escalan con el fin de optimizar los requisitos de almacenamiento y de transporte, que están hechos de 90% materia prima reciclada y son totalmente reciclables. La optimización de los embalajes en términos de volumen y peso ofrece un menor consumo de energía en muchas formas, ayudando al medio ambiente y el consiguiente ahorro en los costes de transporte. A fin de evitar la pérdida de componentes, el embalaje debe eliminarse sólo después de completar el montaje de los productos. Una vez que el producto ha sido desmantelado, el propio producto o sus componentes se debe dar a sistema público de reciclaje, de acuerdo con las normas locales.

#### USOS INADECUADO DEL PRODUCTO

Evite cualquier uso inadecuado del producto; no subir/caminar sobre el producto, no se pare en el reposapiés o en los brazos, no sentarse en el espaldar o en el reposabrazos, no utilice la silla como una escalera. El producto no debe ser sometido a pesos desequilibrados, ya que está diseñado para un descanso adecuado en el punto de apoyo (en cuatro patas o en la base). Cuando levante o mueva el producto, manténgalo en la estructura principal y no sólo bajo el asiento. Gaber® aceptará ninguna responsabilidad por los daños y perjuicios causados a bienes o personas posteriores a un manejo incorrecto o inadecuado del producto. Gaber® se libera de cualquier responsabilidad en caso de daños causados a los suelos frágiles.



### DOCUMENTATION GABER®

Notre documentation contient des informations techniques et des conseils pour l'utilisation des produits, pour les futurs clients Gaber® ou pour qui est déjà en possession d'un produit Gaber®. Dans l'intérêt de la clientèle, Gaber® se réserve le droit de modifier ses modèles, à n'importe quel moment, sans aucun préavis.

Les dessins, les descriptions, les cotes, les matériaux et les couleurs du catalogue et du tarif sont purement indicatifset sous réserve des tolérances. Les dimensions en pouce sont indicatives. Les tonalités des couleurs qui sont représentées sur la carte couleur, relatives aux tissus, au cuir, aux polipro, aux essences de bois sont purement indicatives car elles peuvent varier d'un lot à un autre. Gaber® décline toute responsabilité en ce qui concerne toute différence de tonalité.

Gaber® se réserve le droit de retirer, de suspendre ou de cesser la production de tout article, sans aucun préavis. Tout droit de reproduction, même partielle, des catalogue, relatif aux textes, images, illustrations, dessins, par des moyens mécaniques, électroniques, par photocopie, ou autre source d'information, sans le consentement préalable de Gaber®, est réservé.

### MATERIAUX UTILISES ET LEUR ENTRETIEN

#### Matière plastique

Les billes de technopolymer utilisées par Gaber® pour fabriquer ses produits ont les caractéristiques suivantes : résistance structurel thermique et à l'abrasion. Le technopolymer est non toxique, il est anti statique et anti UV ; ces qualités le rendent très résistant aux agents atmosphériques. Le technopolymer est entièrement recyclable, dans le respect de la charte écologique.

Quelques informations pour l'entretien : les matières plastiques ne doivent pas être en contact avec une source de chaleur directe. Le liquide versé sur un plateau doit être immédiatement essuyé, les articles réservés à un usage externe peuvent subir à la longue l'action d'agents atmosphériques, tels que la salinité,l'humidité, les rayons de soleil, qui peuvent en altérer la superficie et la couleur. Nous recommandons un entretien régulier ainsi qu'un nettoyage correcte et fréquent, ce qui augmentera la durée de vie du produit. L'entretien doit être effectué par des personnes expertes.

Les bouchons des produits Gaber® sont faits d'un composé en caoutchouc à haute résistance d'usure, qui réduit aussi le bruit de trainée. Certains produits Gaber® sont équipés de bouchons avec feutre, adaptés aux sols durs et plus délicats.

Gaber® réalise sur demande, certains articles de sa collection, en polymer "ignifugé" : cependant les additifs qui rendent le produit plastique "ignifugé" peuvent en varier l'esthétique et la résistance.

#### Acier

L'acier utilisé pour la fabrication des structures de tables, chaises, et tabourets Gaber® est très résistant. Il est travaillé sous forme de tube à section carrée ou ronde. La finition peut être chromée ou vernis. Le vernissage spécial à époxy, utilisé par Gaber®, a une résistance optimale aux agents atmosphériques.

#### Aluminium

L'aluminium anodisé utilisé pour la réalisation de structures de tables, chaises et tabourets augmente la résistance à la corrosion. Conseil d'entretien pour les surfaces en acier et/ou en aluminium: nettoyer avec un chiffon doux, humide, imprégné d'eau chaude. Pour les taches éventuelles, on peut ajouter un peu de détergent à usage domestique. Il est recommandé de bien sécher la surface ensuite. Il ne faut pas utiliser de pate et/ou crème pour métal, il ne faut pas utiliser de chlore, de javel ou autre détergents agressifs. Il ne faut pas utiliser de pate ou d'éponges abrasives, qui pourraient endommager en les rayant, les superficies.

#### Bois

Les articles Gaber® avec bois, sont fabriqués selon les norms européennes en vigueur, sans formaldehyde. (par rapport à l'émission de formaldehyde). Le matériel utilisé pour la fabrication des articles ALHAMBRA ECO et EPICA ECO est un mélange de sciure de bois rendu compact et dérivant de matériel recyclé. Il n'y a ainsi aucun gaspillage. Le bois étant une matière naturelle, peut, avec le temps et suivant l'expositionà la lumière, subir de légères modifications au niveau de la couleur. Ces produits, de par leur nature, peuvent s'abimer facilement ; nous tenons aussi à préciser que certaines imperfections correspondent à un standard normal de qualité. Il est recommandé enfin, de ne pas approcher la superficie à une source de chaleur directe. Les superficies se nettoient à l'aide d'un chiffon doux, légèrement humide. Sécher toujours ensuite.

#### Rembourrage en polyuréthane « flexible »

Le rembourrage de certains articles Gaber® est réalisé en polyurethane « flexible », injecté à froid, sans particules de CFC/HCFC (ODP=0 , ne réduit pas la couche d'ozone), ignifugé en classe 1-IM UNI 9175 / CMHR, selon les normes européennes en vigueur.

#### Revêtement : tissus et cuir

Gaber® a au choix une large gamme de couleurs et de trames, choisis parmi des tissus, des cuirs, des ecopelle testés et garantissant une bonne résistance aux frottements, aux abrasions, à la lumière artificielle. Nous avons aussi une gamme de revêtements non feu.

Informations et entretien : nettoyer les peaux avec un chiffon blanc, légèrement humide. Pour l'entretien des tissus, consulter la fiche technique, spécifique.

#### EMBALLAGE ET RECYCLAGE

Nos emballages sont conçus de façon à optimiser le transport et le stockage ; ils sont réalisés à 90% avec du matériel recycle et sont complètement recyclables. L'emballage, optimisé au maximum en ce qui concerne son volume et son poids, permet une économie d'énergie, de main d'oeuvre et de cout de port, sans oublier la sauve garde de notre environnement. Il est vivement conseillé de monter complètement l'article Gaber® avant de procéder à l'élimination du carton, ceci, afin d'éviter de perdre la visserie et / ou les divers composants de l'article en question. Lorsqu'un produit Gaber® arrive en fin de vie, il est recommandé de porter les diverses parties qui le compose à la déchèterie, selon la loi du pays en vigueur

### USAGE INCORRECT DES PRODUITS

Les tables, chaises, tabourets ou repose pieds ne sont pas fait pour monter dessus, il ne faut pas s'asseoir sur les dossiers ou les accoudoirs ou se servir de ces articles comme d'un escabeau. Il faut éviter de se balancer d'avant en arrière sur les assises, de façon à éviter les accidents. Pour soulever ou déplacer une chaise ou tabouret, il est recommandé de le prendre par le châssis et non par l'assise. Le produit ne doit pas être soumis à des charges excessives ou décentrées, il a été conçu pour un usage normal de simple appui (sur 4 pieds ou sur pied central).

Gaber® décline toute responsabilité pour les dommages causés à personne ou choses, qui pourraient dériver d'un usage incorrect du produit. L'usine décline aussi toute responsabilité pour les dommages sur parquets ou sol délicats.



## GABER® DOKUMENTATION

Die Dokumentation von Gaber® beinhaltet technische Informationen und Ratschläge zur Nutzung von Gaber® Produkte für Kaufinteressenten bzw. für Besitzer von Artikeln, die zur Produktpalette der Gaber® angehören. Im Interesse der Kunden behält sich Gaber® das Recht vor die eigenen Modelle jederzeit abzuändern, ohne Pflicht zur Vorankündigung. Die Zeichnungen, die Quoten, die Materialien und die Farben der Kataloge und der Preislisten der Gaber® dienen lediglich als Information und unterliegen Toleranzen. Die Maßen, die in Zoll angegeben sind, sind als Richtwerte zu betrachten. Die dargestellten Farbtöne, auch die in den Farbpaletten, sowie die Stoff-, Leder-, Lack-, Glas- und Holzverkleidungen sind Indikativ, da von Fall zu Fall Änderungen möglich sind. Gaber® lehnt jegliche Verantwortung in Verbindung mit Farbtonabweichungen ab. Gaber® behält sich zudem das Recht vor die Produktion jedes einzelnes Produkts zurückzuziehen, einzustellen bzw. abzutreten. Die Rechte an der Reproduktion von Kataloge und Preislisten der Gaber® in Bezug auf Texte, Bilder, Illustrationen, Zeichnungen, die sowohl mit mechanischen als auch mit elektronischen Mitteln, Kopien inbegriffen, erfolgen sind weltweit der Gaber® vorbehalten und benötigen eine schriftliche Genehmigung der Gaber®.

## VERWENDETE MATERIALIEN UND WARTUNG

### Kunststoffmaterialien

Die von Gaber® benutzte „Tecnopolymer-Verbindung“ für die Realisierung der eigenen Produkte sind durch hohe strukturelle, thermische und abriebfeste Resistenz gekennzeichnet. Das „Tecnopolymer“, welcher Bestandteil der Produkte Gaber® ist, ist ungiftig, schmutzabweisend, antistatisch und anti-UV: Eigenschaften, die der Produkte Gaber® eine optimale Resistenz gegen die atmosphärischen Einflüsse verleiht. Die verwendeten „Tecnopolymer“ sind, in Beachtung der Umwelt, vollständig recycelbar. Gaber® produziert thermoplastische Artikel ohne chemische Zusätze und, wo möglich, wird recyceltes „Tecnopolymer“ aus wiederverwendeten Altstoffen benutzt.

Richtlinien für die korrekte Verwendung: die verwendeten Kunststoffmaterialien vertragen keine direkte Wärmezufuhr auf die Oberfläche. Die Kunststoffoberflächen der Produkte Gaber® können mit einem feuchten und weichen Tuch, getränkt in Wasser, gereinigt werden. Für die hartnäckigsten Flecken kann man mit Vorsicht eine neutrale flüssige Seife in Wasser verdünnen. Verwenden Sie keine Nagellackentferner, Trichlorethylen, Ammoniak, alkoholische Substanzen oder sonstige Reinigungsmittel, die auch nur kleine Mengen solcher Substanzen enthalten. Es sollte zudem nicht mit Schleif- bzw. Lösungsmittel in Kontakt treten oder mit grobe Reinigungsgeräte. Die auf die Produkte Gaber® verschütteten Flüssigkeiten müssen sofort abgetrocknet werden. Produkte, die für den Außenbereich bestimmt sind, erleiden mit der Zeit die wetterbedingten Einwirkungen. Eventuelle oberflächliche Änderungen können aufgrund bestimmter Temperatur-, Feuchtigkeits- oder Salzgehaltsbedingungen auftreten. Eine direkte Sonneneinstrahlung kann eine Farbänderung des Produktes verursachen. Eine korrekte und regelmäßige Wartung und Reinigung erhöht die Haltbarkeit des Produkts. Wartungsmaßnahmen sollten von einem spezialisierten Personal vorgenommen werden. Die Kappen und Schutzvorrichtungen der Gaber®-Produkte sind in einer Gummimischung mit hoher Verschleißfestigkeit gemacht, zur Reduzierung von Schleppgeräuschen. Einige Gaber®-Produkte sind Filzstöpseln ausgestattet, die für starre und empfindlichere Böden geeignet sind.

Gaber® realisiert auf Anfrage einige Produkte der eigenen Kollektion mit feuerfesten „Tecnopolymer“: die Zusatzstoffe, die das Kunststoffmaterial feuerfest machen, können die Ästhetik und die Resistenz der Produkte grundlegend verändern.

Die Kappen und Schutzvorrichtungen der Gaber-Produkte sind in einer Gummimischung mit hoher Verschleißfestigkeit gemacht, zur Reduzierung von Schleppgeräuschen. Einige Gaber-Produkte sind Filzstöpseln ausgestattet, die für starre und empfindlichere Böden geeignet sind.

### Der Stahl

Bei den Strukturen von Tischen, Stühlen und Hockern wird hochfester Stahl verwendet, diese werden von Gaber® mittels rund- bzw. quadratförmige Röhre realisiert. Die Produkte sind in verchromter oder lackierter Ausführung erhältlich. Die spezielle Lackierung aus Epoxidpulver, die von Gaber® an vielen Strukturen verwendet wird, erreicht eine optimale Resistenz gegen die atmosphärischen Einflüsse.

### Das Aluminium

Gaber® benutzt das Aluminium für die Realisierung der Strukturen von Tischen, Stühlen und Hockern. Mittels einer speziellen Verarbeitung der Oberflächen einiger Produkte Gaber®, des Anodisieren, wird die Korrosionsresistenz erhöht. Richtlinien für die korrekte Verwendung: sowohl die Stahl- als auch die Aluminiumoberflächen müssen mit einem feuchten und weichen Tuch, durchtränkt in heißem Wasser, gereinigt werden. Für die hartnäckigsten Flecken kann man mit Vorsicht eine neutrale flüssige Seife in Wasser verdünnen. Nach der Reinigung sollte die Oberfläche immer mit einem weichen Tuch abgetrocknet werden. Verwenden Sie keine Cremes oder Pasten um die Metalle zu reinigen, sowie kein Chlor, Bleichmittel oder sonstige aggressive Reinigungsmittel. Benutzen Sie auch keine groben Pasten oder schleifende Schwämme, die die Metalloberflächen verkratzen könnten.

### Das Holz

Die Produkte Gaber® mit Holzelemente werden in Übereinstimmung mit den geltenden europäischen Vorschriften bezüglich der Emission von Formaldehyd hergestellt. „Compound-Wood“ ist das besondere Material, das von Gaber® für die Realisierung der Produkte „Alhambra-Eco“ und „Epica-Eco“, verwendet wird. Dieses Material benutzt die Holzfasern aus dem Produktionsprozess, mit welchem Gaber® die Holzelemente herstellt. Es wird nichts verschwendet. Richtlinien für die korrekte Verwendung: Die Holzoberfläche kann mit der Zeit durch die Benutzung oder die Sonneneinstrahlung eine Farbänderung erleiden, da es sich um ein natürliches Material handelt. Zudem sind die Oberflächen, aufgrund Ihrer Natur, leicht zu beschädigen. Einige kleine Unreinheiten und Macken liegen im annehmbaren Qualitätsstandard. Die Holzoberflächen vertragen keine direkte Wärmezufuhr. Reinigen Sie die Holzoberflächen mit einem feuchten und weichen Tuch, durchtränkt in lauwarmes Wasser. Trocknen Sie das Produkt sofort nach der Reinigung.

### Polsterung in flexibles Polyurethan

Die Polsterung einiger Produkte von Gaber® besteht aus flexiblem Polyurethan, kaltgepresst, ohne CFC/HCFC (ODP=0: es trägt nicht zur Reduzierung der atmosphärischen Ozonschicht bei), selbstlöschend der Klasse 1-IM UNI 9175/CMHR, gemäß der geltenden europäischen Vorschriften.

### Die Bezüge: Stoffe und Leder

Gaber® verwendet Stoffe und Leder, die zu einer umfassenden Palette an Farben und Mustern gehören, die alle aus einer Reihe getesteter Produkte ausgewählt wurden, mit dem Ziel die beste Leistung wie die Abriebfestigkeit und Resistenz gegen künstliches Lichtes zu erzielen. Es sind Kategorien feuerfester Stoffe und künstliche Lederbezüge erhältlich. Richtlinien für die korrekte Verwendung: Reinigen Sie das Leder mit einem weißen Tuch, der nur mit Wasser befeuchtet werden sollte.

## VERPACKUNG UND RECYCLING

Unsere Verpackungen wurden mit dem Ziel realisiert den Lager und Transport zu optimieren. Sie bestehen zu 90% aus recycelten Materialien und sind vollständig recycelbar. Die Optimierung der Verpackung in Bezug auf Volumen und Gewicht führt zu einem geringeren Energieverbrauch, mit einer folgenden Einsparung bei den Transportkosten und einer wichtige Hilfe zum Schutz der Umwelt. Um den Verlust von Bauteilen zu vermeiden, wird es empfohlen die Verpackung erst nach Abschluss der Montage der Produkte zu entsorgen. Nach der Montage kann das Produkt oder seine Bestandteile dem öffentlichen Entsorgungssystem gemäß den geltenden örtlichen Vorschriften übergeben werden.

## UNSACHGEMÄSSE VERWENDUNG DES PRODUKTS

Als eine unpassende bzw. unkorrekte Verwendung des Produkts wird folgendes angesehen: auf Tische, Stühle und Hockern aufstehen, auf Rücken- und Armlehnen niedersetzen, die Produkte als Treppchen zu nutzen. Das Schwenken des Produktes könnte das Produkt oder dessen Funktion beschädigen und die Sicherheit des Nutzers gefährden. Um das Produkt anzuheben oder zu verschieben wird empfohlen es an der Hauptstruktur und nicht unter dem Sitz zu halten. Das Produkt sollte keiner dezentralen Last ausgesetzt sein, da es für die Nutzung in normalen Konditionen geplant wurde. Gaber® übernimmt keine Haftung für Schäden an Sachen oder Personen, die durch unsachgemäße Verwendung des Produkts verursacht wurden. Gaber® lehnt zudem jede Haftung für Schäden an empfindlichen Böden oder Oberflächen ab.



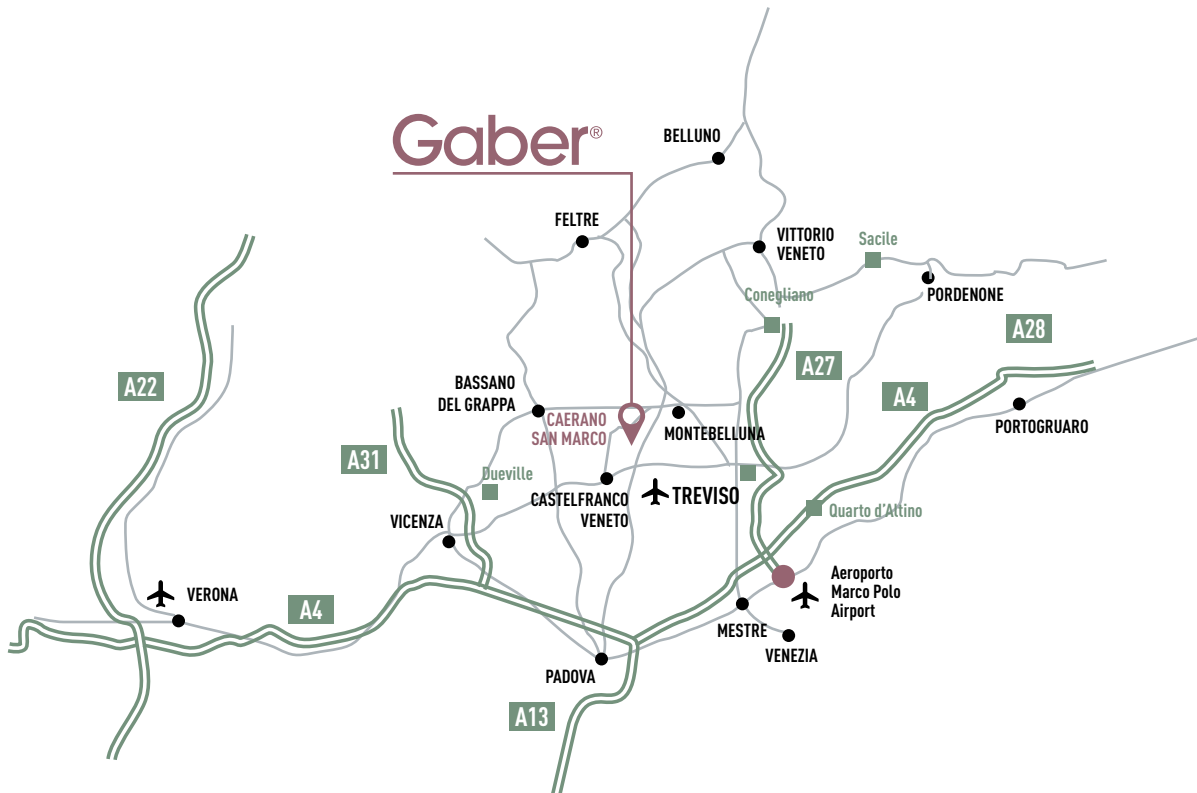

**Gaber**  
Via Altivole, 3  
31031 Caerano San Marco (TV)  
ITALY  
+39 0423 915521  
info@gaber.it  
gaber.it

Gaber®

[gaber.it](http://gaber.it)