

LC

Collection

Taco

Twirl

Borgo

Idda

+4

laCividina

Collection

Taco

CHAIR

Twirl

ARMCHAIR

Borgo

COFFEE TABLE

Idda

COFFEE TABLE

TACO

TACO cod. 1400
Chair



Taco

Family	Chair
Designer	Alessandro Stabile / 2022
Link	www.read-mo.re/taco

IT Taco è la poltroncina che smaterializza e rende leggero l'imbottito, sottraendone la tradizionale struttura in legno e poliuretano espanso. Composta solamente da due strati di feltro naturale e un'anima sottile in acciaio interna alla seduta, la scocca viene lavorata in piano per poi assumere tridimensionalità una volta piegata sul telaio, che ne tiene uniti i lembi tramite precise fresature. In modo naturale, forme morbide e nette trovano il proprio equilibrio, creando un design ergonomico e trasversale all'utilizzo residenziale e contract.

EN

The Taco soft chair dissipates padding and makes it lighter, stripping away the traditional wooden and polyurethane foam structure. Consisting solely of two layers of natural felt with a slender steel core inside the seat, the body is flat when it is produced and it is given a three-dimensional form when it is folded onto the frame, which holds the edges together thanks to precision milling. A natural balance is struck between soft and clean-cut forms, in a versatile, ergonomic design that is suitable for both the home and contract markets.

FR

Taco est le petit fauteuil qui dématérialise le rembourrage et le rend léger, en le débarrassant de la structure traditionnelle en bois et en mousse de polyuréthane. Composée uniquement de deux couches de feutre naturel et d'une âme fine en acier à l'intérieur de l'assise, la coque est façonnée à plat pour prendre ensuite une forme tridimensionnelle une fois pliée sur le cadre, qui maintient les bords solidaires grâce à un fraisage de précision. De manière naturelle, les formes douces et épurées trouvent leur équilibre, créant un design ergonomique qui s'applique aussi bien à un usage résidentiel qu'à un usage professionnel.

DE

Taco ist ein kleiner Sessel, der die Polsterung vom Stofflichen befreit und somit „erleichtert“, indem er auf die traditionelle Struktur aus Holz und Polyurethanschaum verzichtet. Die Schale besteht nur aus zwei Schichten Naturfilz und einem schlanken Federstahlkern im Inneren des Sitzes, ist flach gearbeitet und wird erst dreidimensional, wenn sie auf den Rahmen gespannt wird, der die Kanten in präzisen Fräsungen zusammenhält. Die weichen, klaren Formen finden ihr natürliches Gleichgewicht und lassen ein ergonomisches Design entstehen, das im Wohn- und Contractbereich in vielseitiger Weise eingesetzt werden kann.

TACO cod. 1400
Chair /
NODE+ cod. 1347
Coffee table /
TURI TURI cod. 8770_D30
Coffee table



CHAIR



COLLECTION

TACO

TACO cod. 1400
Chair /
BORGIO cod. 1430
Coffee table

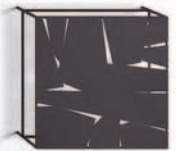
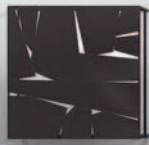
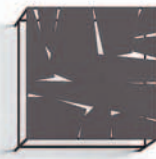

CHAIR



TACO cod. 1400
Chair

TACO

TACO cod. 1400
Chair /
U cod. 1106
Coffee table



CHAIR



COLLECTION

TACO

TACO cod. 1400
Chair



CHAIR

Dati tecnici · Technical data · Données techniques · Technische Angaben

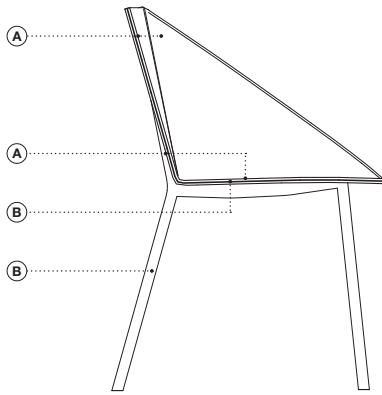

A. Rivestimento fisso in feltro
B. Metallo

A. Fixed upholstery in felt
B. Metal

A. Revêtement pas déhoussable en feutre
B. Métal

A. Unabziehbarer Bezug aus Filz
B. Metall

Caratteristiche · Features · Caractéristiques · Eigenheiten

· Basi personalizzabili con colore su richiesta del cliente

· Bases customizable with other colors on customer's request

· Piètements disponibles en autres finitions sur demande

· Gestell in Kundenfarben auf Anfrage verfügbar

Coordinati · Matching items · Produits assortis · Abgestimmte Produkte



NODE+



TURI TURI

MIL



SCANCARÒ

Finiture in metallo · Metal finishes · Finitions métal · Metallausführungen



Avorio
Ivory
Ivoire
Elfenbein



Nero pece
Pitch black
Poix noir
Pech Schwarz

cod. 1400 / chair



62 cm
24 3/8"



58 cm
22 7/8"

70 cm
31 1/8"

45 cm
17 3/4"

TWIRL

TWIRL cod. 1411
Armchair



Twirl

Family	Armchair
Designer	Gordon Guillaumier / 2022
Link	www.read-mo.re/twirl

IT Con un vortice irregolare e sottile, Twirl sintetizza in un unico divanetto gli elementi di seduta, scrittoio e schermatura. Il piccolo piano d'appoggio, dotato di prese elettriche e USB, dà origine alla spirale che diventa al tempo stesso schienale e paravento, offrendo il comfort visivo e acustico ideale per lavorare anche in ambienti open space. Una nicchia privata resa ancora più accogliente dai volumi generosi della seduta e dall'inedito utilizzo di materiali morbidi e flessibili, sostenuti da un'impercettibile struttura in legno.

EN

The Twirl single sofa combines the features of a seat, a desk and a screen in one slender, swirling shape. The little support surface equipped with electrical and USB sockets is the starting point for a spiral that serves as both a backrest and a partition, providing ideal visual and acoustic comfort for people to work anywhere, including in open-plan environments. The private alcove is made even more welcoming by the generous size of the seat and the original use of soft, flexible materials that are supported by an imperceptible wooden framework.

FR

Avec sa forme tourbillonnante irrégulière et légère, Twirl réunit les fonctions de siège, de bureau et de cloison en un seul petit canapé. Du petit plan d'appui, équipé de prises électriques et USB, se déploie la spirale qui fait office à la fois de dossier et de paravent, offrant un confort visuel et acoustique idéal pour travailler n'importe où, y compris en open space. Cette alcôve privée est rendue encore plus accueillante par les volumes généreux du siège et l'utilisation inédite de matériaux doux et souples, soutenus par une structure en bois imperceptible.

DE

Wie ein unregelmäßiger, graziler Strudel formt Twirl die Elemente eines Sitzmöbels, Schreibpults und eines Wandschirms und vereint sie in einem einmaligen, alkoventartigen Sofa. Aus der kleinen Ablage, die mit Steckdosen und USB-Buchsen ausgestattet ist, entwickelt sich eine Spirale, die gleichzeitig als Rückenlehne und Abschirmung dient und auch im offenen Ambiente einen idealen visuellen und akustischen Arbeitskomfort bietet. Eine Nische, die zum Rückzug einlädt und durch die großzügig bemessene Sitzfläche und die verwendeten weichen und flexiblen Materialien, getragen von einer unsichtbaren Holzstruktur, noch gemütlicher wird.

TWIRL

TWIRL cod. 1411
Armchair /
TWIRL cod. 1412
Armchair /
IDDA cod. 1421
Coffee table



ARMCHAIR



COLLECTION

TWIRL

TWIRL cod. 1411
Armchair /
BORGO cod. 1430
Coffee table /
BORGO cod. 1432
Coffee table



ARMCHAIR



COLLECTION

TWIRL

TWIRL cod. 1411
Armchair /
BORG cod. 1430
Coffee table /
BORG cod. 1432
Coffee table



ARMCHAIR

TWIRL cod. 1411

Armchair /

TWIRL cod. 1412

Armchair /

SCANCARÒ cod. 8831

Coffee table /

SCANCARÒ cod. 8834

Coffee table



TWIRL

TWIRL cod. 1411
Armchair /
BORGO cod. 1430
Coffee table /
BORGO cod. 1431
Coffee table



ARMCHAIR



COLLECTION

TWIRL

TWIRL cod. 1411
Armchair



Dati tecnici · Technical data · Données techniques · Technische Angaben

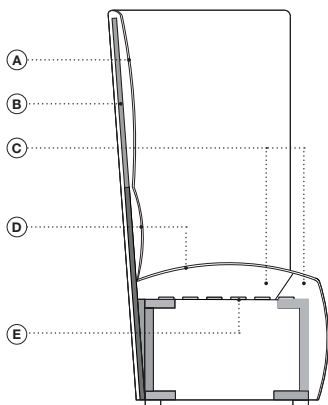

- Legno massiccio faggio
- Multistrato di faggio
- A. Rivestimento
- B. Polipropilene
- C. Poliuretano espanso ignifugo a quote differenziate
- D. Fibra di poliestere
- E. Cinghie elastiche ad alta densità

- Bois de hêtre massif
- Multiplis de hêtre
- A. Revêtement
- B. Polypropylène
- C. Mousse polyuréthane expansé ignifuge indéformable à épaisseurs différenciées
- D. Fibre de polyester
- E. Sangles élastiques

- Solid beech
- Multilayered beech
- A. Upholstery
- B. Polypropylene
- C. Flame-retardant undeformable polyurethane foam of different densities
- D. Polyester fibers
- E. High density elastic straps

- Massiveholz Buche
- Buchenschinchholz
- A. Bezug
- B. Polypropylen
- C. Polyurethanschaum Feuerfester formbeständige in unterschiedlicher Dichte
- D. Polyester
- E. Elastischen Gurtbändern

Caratteristiche · Features · Caractéristiques · Eigenheiten

- Telaio rinforzato per uso aree pubbliche
- Poliuretano espanso ignifugo
- Poliuretano espanso indeformabile a quote differenziate ad alta densità
- Cuciture rinforzate con supporto in fibra di carbonio
- Su richiesta attacco per connessione elettrica e USB

- Reinforced frame for public area use
- Flame-retardant polyurethane foam
- Undeformable polyurethane foam of different densities
- Reinforced stitching with carbon fiber support
- Electrical connection and USB upon request

- Structure renforcée pour une utilisation en espace public
- Mousse polyuréthane expansé ignifuge
- Mousse polyuréthane expansé indéformable à épaisseurs différenciées
- Coutures renforcées de fibre de carbone
- Sur demande connection électrique et USB

- Verstärkte Holzstruktur für Nutzung bei öffentlichem Bereich
- Feuerfester Polyurethanschaum
- Formbeständige Polyurethanschaum unterschiedlicher Dichte
- Verstärkte Säume mit Stütz aus Kohlefaser
- Elektrische Verbindung und USB-Anschluss auf Anfrage

Coordinati · Matching items · Produits assortis · Abgestimmte Produkte



NODE+



ACCURSIO



TURI TURI



SCANCARÒ

Finiture tavolo · Table finishes · Finitions de table · Tischausführungen



Avorio
Ivory
Ivoire
Elfenbein



Nero pece
Pitch black
Poix noir
Pech Schwarz

cod. 1411 / armchair with right table

cod. 1412 / armchair with left table

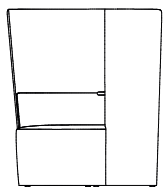

110 cm
43 1/4"

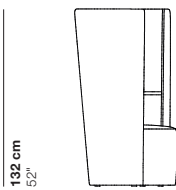

80 cm
31 1/2"



44 cm
17 3/8"

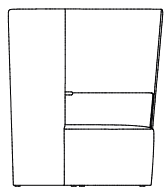

110 cm
43 1/4"

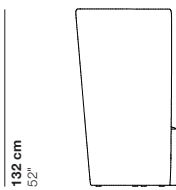

80 cm
31 1/2"



44 cm
17 3/8"

BORG

BORG cod. 1430
Coffee table /
BORG cod. 1431
Coffee table



Borgo

Family	Coffee Table
Designer	Antonino Sciortino / 2022
Link	www.read-mo.re/borgo

IT Il tavolino Borgo è un foglio in acciaio sul quale sono stati praticati dei tagli irregolari che, collegati tra loro, ricordano le viuzze di un caratteristico paese siciliano. L'ispirazione nasce dal Cretto di Burri, opera di land art che appare come una serie di fratture sul terreno, quando vista dall'alto. Il coffee table Borgo ha una struttura realizzata in tondino d'acciaio, ha una forma quadrata e rettangolare, è disponibile in tre dimensioni. I colori spaziano dal pastello alle finiture speciali in bronzo, ottone e rame.

EN

The top of the Borgo coffee table is made of sheet steel featuring cuts at irregular intervals that are interconnected and call to mind the narrow streets of a picturesque Sicilian town. The inspiration came from the Cretto di Burri: a landscape artwork that looks like a series of cracks in the ground when viewed from above. The coffee table has a structure made from round steel bars and a rectangular shape. It comes in three different sizes. The colours range from pastel hues to special bronze, brass and copper finishes.

FR

La table basse Borgo est une feuille d'acier sur laquelle ont été pratiquées des entailles irrégulières qui, une fois reliées, évoquent les ruelles d'un petit village sicilien typique. Le créateur s'est inspiré du Cretto di Burri, une œuvre du land art qui, vue d'en haut, apparaît comme une série de fractures sur le terrain. La table basse Borgo repose sur une structure en tige d'acier, arbore une forme carrée et rectangulaire, et est proposée en trois tailles. La palette de couleurs va du pastel aux finitions spéciales en bronze, laiton et cuivre.

DE

Der Couchtisch Borgo besteht aus einem Stahlblatt mit unregelmäßigen, miteinander verbundenen Einschnitten, die an die verwinkelten Gassen eines charakteristischen Dorfes auf Sizilien erinnern, und wurde von Alberto Burris' Land-Art-Werk „Cretto“ inspiriert, das aus der Vogelperspektive wie eine von Spalten durchzogene Landschaft erscheint. Der Beistelltisch Borgo hat eine quadratische, rechtwinklige Struktur und ist in drei Größen und verschiedenen Pastellfarben sowie in Spezialausführungen aus Bronze, Messing und Kupfer erhältlich.

BORGO

BORGO cod. 1431
Coffee table /
PINCH cod. 9101
Armchair



COFFEE TABLE

BORG cod. 1430
Coffee table /
BORG cod. 1431
Coffee table



BORGO

BORGO cod. 1431
Coffee table /
SUISEKI cod. SUI04
Sofa composition

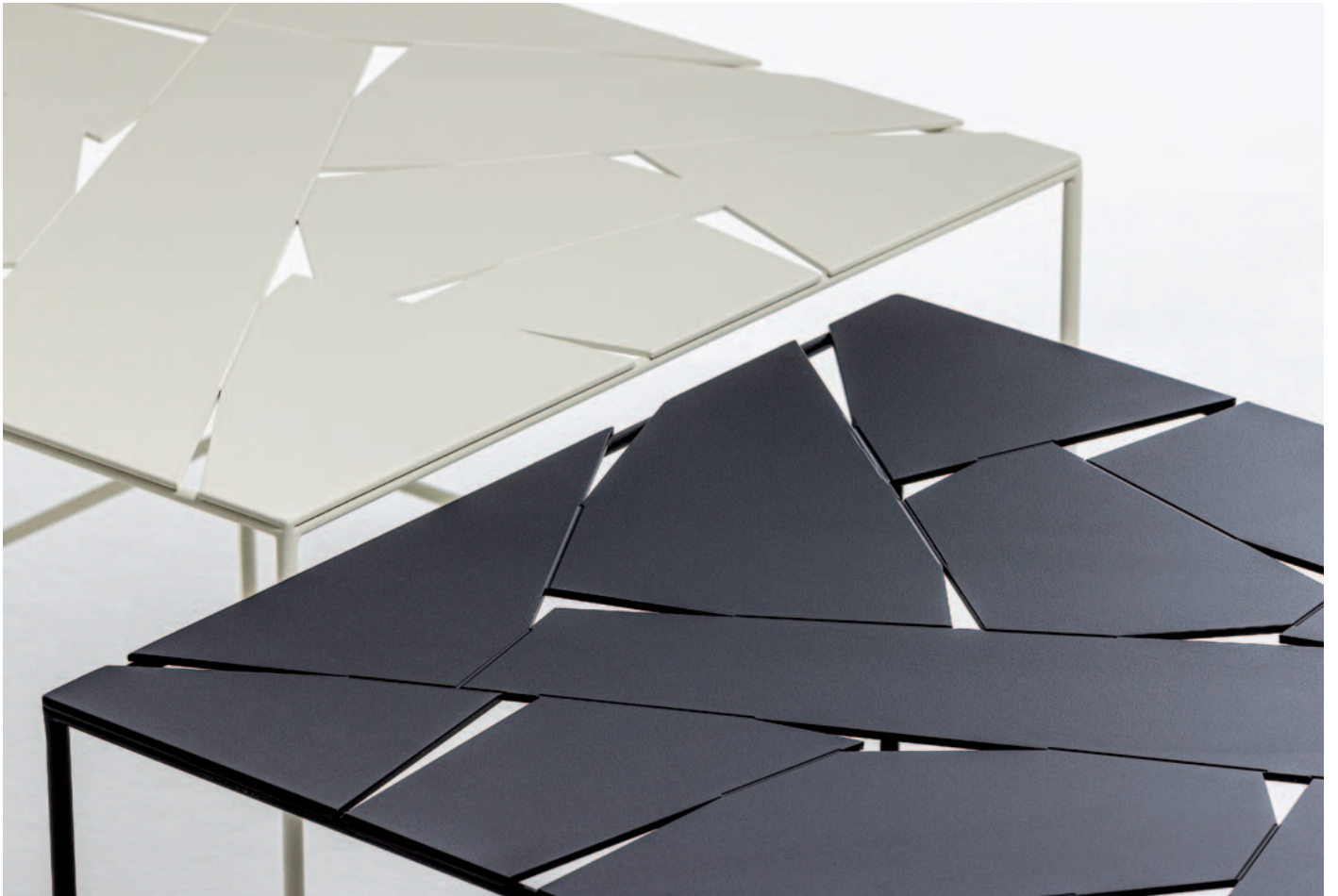

COFFEE TABLE



COLLECTION

BORGO

BORGO cod. 1431
Coffee table



COFFEE TABLE

Dati tecnici · Technical data · Données techniques · Technische Angaben

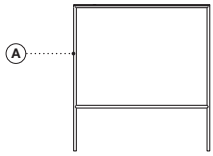

A. Acciaio

A. Acier

A. Steel

A. Stahl

Finiture · Finishes · Finitions · Ausführungen



Avorio
Ivory
Ivoire
Elfenbein



Fango
Mud
Boue
Schlamm



Prugna
Plum
Prune
Pflaume



Cioccolato
Chocolate
Chocolat
Schokolade



Nero pece
Pitch black
Poix noir
Pech Schwarz



Tè verde
Green tea
Thé vert
Grüner Tee



Fiordaliso
Cornflower
Bleuet
Kornblume



Laccato bronzo
Lacquered bronze
Laqué bronze
Bronze lackiert



Laccato ottone
Lacquered brass
Laqué laiton
Messing lackiert



Laccato rame
Lacquered copper
Laqué cuivre
Kupfer lackiert

cod. 1430 / coffee table

cod. 1431 / coffee table

cod. 1432 / coffee table

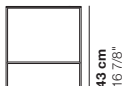

43 cm
16 7/8"



40 cm
15 6/8"



35 cm
13 6/8"



50 cm
19 5/8"



50 cm
19 5/8"



65 cm
25 5/8"

35 cm
13 6/8"

IDDA

IDDA cod. 1420
Coffee table /
IDDA cod. 1421
Coffee table



Idda

Family	Coffee Table
Designer	Antonino Sciortino / 2022
Link	www.read-mo.re/idda

IT Una scultura prestata alla funzione di tavolino, che omaggia la bellezza dell'Etna e delle sue sinuose colate di lava. Idda rievoca la silhouette capovolta del vulcano, attraverso una struttura in lamiera che si fa straordinariamente delicata e armonica. Fasce curvate a mano e di diverse dimensioni si sovrappongono l'una sull'altra, in tre o cinque piani di altezza, dando forma a un coffee table dalle volumetrie piene e naturali.

EN

This sculpture serves as a table and pays tribute to the beauty of Mount Etna, with its winding lava flows. Idda's exceptionally delicate and harmonious sheet metal structure takes the outline of the volcano and turns it upside down. Strips of different sizes are bent by hand and placed on top of each other to form three or five layers, creating a coffee table with full, natural shapes.

FR

Une sculpture prêtée à la fonction de table basse, qui rend hommage à la beauté de l'Etna et de ses sinueuses coulées de lave. La structure en tôle d'Idda, incroyablement délicate et harmonieuse, évoque la silhouette renversée du volcan. Des bandes incurvées à la main et de différentes tailles se chevauchent sur trois ou cinq niveaux, donnant corps à une table basse aux volumes pleins et naturels.

DE

Der Beistelltisch Idda hat die Form einer Skulptur und ist eine Hommage an den eindrucksvollen Ätna und seine sich schlängelnden Lavaströme. Idda beschwört mit ihrer Struktur aus Metallblech die kopfüber stehende Silhouette des Vulkans herauf, die außerordentlich zart und harmonisch wirkt. Die von Hand gebogenen Bänder in unterschiedlichen Größen überlagern sich, bilden drei oder fünf Ebenen und formen einen Couchtisch mit vollem, natürlichem Volumen.

IDDA

IDDA cod. 1421
Coffee table /
SUISEKI cod. SUI04
Sofa composition



COFFEE TABLE



COLLECTION

IDDA

IDDA cod. 1420
Coffee table /
IDDA cod. 1421
Coffee table /
SUISEKI cod. SUI04
Sofa composition





IDDA cod. 1420
Coffee table /
IDDA cod. 1421
Coffee table

IDDA

IDDA cod. 1421
Coffee table



COFFEE TABLE

Dati tecnici · Technical data · Données techniques · Technische Angaben

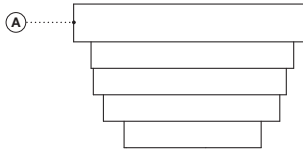

A. Acciaio

A. Acier

A. Steel

A. Stahl

Finiture · Finishes · Finitions · Ausführungen



Avorio
Ivory
Ivoire
Elfenbein



Fango
Mud
Boue
Schlamm



Prugna
Plum
Prune
Pflaume



Cioccolato
Chocolate
Chocolat
Schokolade



Nero pece
Pitch black
Poix noir
Pech Schwarz



Tè verde
Green tea
Thé vert
Grüner Tee



Fiordaliso
Cornflower
Bleuet
Kornblume



Laccato bronzo
Lacquered bronze
Laqué bronze
Bronze lackiert



Laccato ottone
Lacquered brass
Laqué laiton
Messing lackiert



Laccato rame
Lacquered copper
Laqué cuivre
Kupfer lackiert

cod. 1420 / coffee table

cod. 1421 / coffee table



38 cm
15"



61 cm
24"

57 cm
22 1/2"

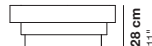

28 cm
11"



76 cm
28 7/8"

71 cm
28"

LaCividina srl

**HEADQUARTERS
/ PRODUCTION**

Via Spilimbergo 162
33035 Martignacco
Udine Italy

T. + 39 0432 677433
F. + 39 0432 677480
info@lacividina.com
www.lacividina.com

COMPANY SHOWROOM

Via Lungolavia 1
33035 Martignacco
Udine Italy
T. + 39 0432 677433



Press Office

Carter&Bennett
pr@carterandbennett.com
tel. +39 0432 1746101

/ LaCividina s.r.l., al fine di migliorare le caratteristiche tecniche e qualitative della sua produzione, si riserva di apportare, anche senza preavviso, tutte le modifiche che si rendessero necessarie.

/ With a view to improving the technical characteristics and quality of its products, LaCividina s.r.l. reserves the right to develop its products at any time without notice.

/ Afin d'améliorer les caractéristiques techniques et qualitatives de sa production, LaCividina s.r.l. se réserve d'apporter, même sans préavis, toutes les modifications qui se rendront nécessaires.

/ Zur Verbesserung der technischen und qualitativen Merkmale behält sich LaCividina s.r.l. vor, alle notwendig erscheinenden Produktionsänderungen auch ohne Vorankündigung durchzuführen.

Company Art Director

Luca Botto

Graphic Design

Designwork

Photo

Alessandro Paderni / Studio Eye

2D/3D development

Michele Poletto

Render

Nudesign Studio

Copywriting

Carter&Bennett

Made and printed in Italy

Grafiche Manzanesi
May 2022



LaCividina srl

**HEADQUARTERS
/ PRODUCTION**

Via Spilimbergo 162
33035 Martignacco
Udine Italy

T. + 39 0432 677433

F. + 39 0432 677480

info@lacividina.com

www.lacividina.com

COMPANY SHOWROOM

Via Lungolavia 1
33035 Martignacco
Udine Italy

T. + 39 0432 677433